

**6.0-15.0V**  
**Input**

**0.8-5.0V**  
**Outputs**

**30 Amp**  
**Current**

**Non**  
**Isolated**

**SMT**  
**Surface Mount**

The NiQor® SMT DC/DC converter is a non-isolated buck regulator, which employs synchronous rectification to achieve extremely high conversion efficiency. The NiQor family of converters are used predominately in DPA systems using a front end DC/DC high power brick (48Vin to low voltage bus). The non-isolated NiQor converters are then used at the point of load to create the low voltage outputs required by the design. The wide trim module can be programmed to a variety of output voltages through the use of a single external resistor. RoHS compliant see last page.

# NiQor®

**Non-Isolated**



*NiQor surface mount module*

### Operational Features

- Ultra high efficiency, up to 93% at full rated load
- Delivers up to 30 Amps of output current with minimal derating - no heatsink required
- Input Voltage Range : 6.0 - 15.0V
- Fast transient response time
- On-board input and output filter capacitor
- No minimum load requirement means no preload resistors required

### Mechanical Features

- DOSA standard SMT pin-out configuration
- Industry standard size: 1.3" x 0.53" x 0.32" (33 x 13.5 x 8.12 mm)
- Total weight: 0.18 oz. (5 grams), lower mass greatly reduces vibration and shock problems
- Open frame construction maximizes air flow cooling
- Also available in SIP packaging

### Control Features

- On/Off control
- Output voltage trim (industry standard) permits custom voltages and voltage margining
- Remote Sense (standard option)
- Active Current Sharing for Parallel Applications



### Protection Features

- Input under-voltage lockout disables converter at low input voltage conditions
- Temperature compensated over-current shutdown protects converter from excessive load current or short circuits
- Output over-voltage protection protects load from damaging voltages
- Thermal shutdown protects converter from abnormal environmental conditions

### Safety Features

- UL/cUL 60950-1 recognized (US & Canada)
- TUV certified to EN60950-1
- Meets 72/23/EEC and 93/68/EEC directives which facilitates CE Marking in user's end product
- Board and plastic components meet UL94V-0 flammability requirements

### MECHANICAL DIAGRAM

#### Surface Mount Package

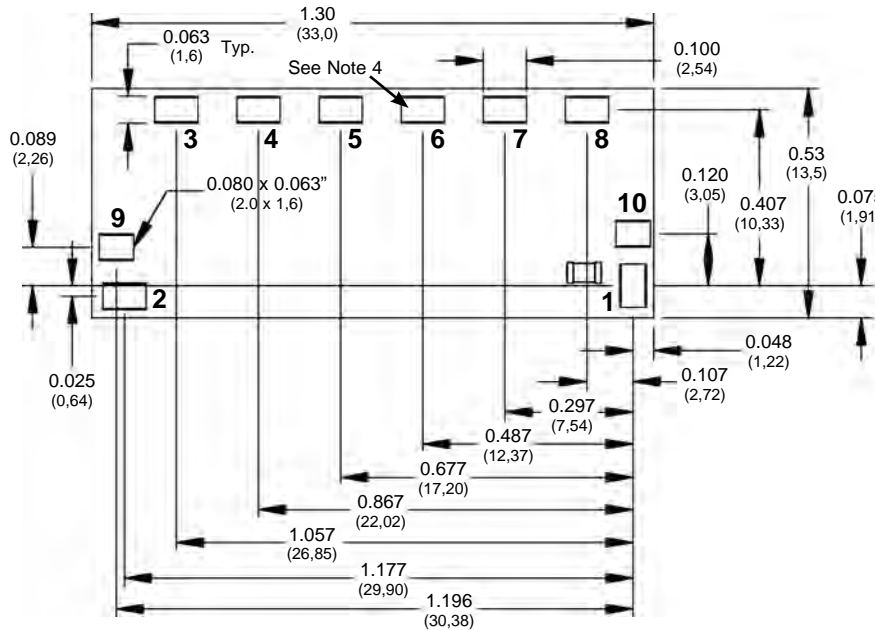

**Bottom View**

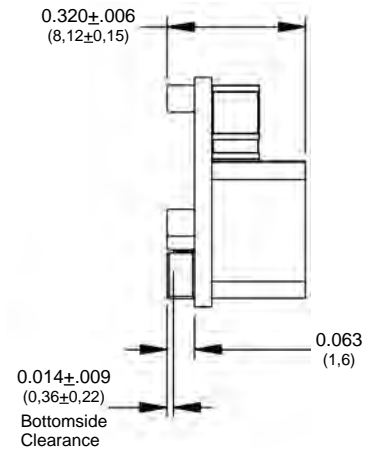

**Side View**

**Recommended SMT Pad Size:**

Minimum: 0.074" x 0.122" (1.88mm x 3.1mm)  
 Maximum: 0.095" x 0.140" (2.41mm x 3.56mm)

### NOTES

- 1) SMT Contacts: Material - Brass  
 Finish - Gold over Nickel plate
- 2) Undimensioned components are shown for visual reference only.
- 3) All dimensions in inches (mm)  
 Tolerances: x.xx +/-0.02 in. (x.x +/-0.5mm)  
 x.xxx +/-0.010 in. (x.xx +/-0.25mm)
- 4) Coplanarity for pins 1-10 is 0.004" max
- 5) Weight: 0.18 oz. (5 g) typical
- 6) Workmanship: Meets or exceeds IPC-A-610C Class II

### SMT CONTACT DESIGNATIONS

Pin No.	Name	Function
1	ON/OFF	Input to turn converter on/off
2	Vin(+)	Positive input voltage
3	N/C	No Connection
4	GND	Ground
5	Vout(+)	Positive output voltage
6	TRIM	Output Voltage Trim
7	SENSE(+)	Positive remote sense
8	IShare	Current share
9	<i>GND</i>	<i>Ground</i>
10	<i>GND</i>	<i>Ground</i>

*Pins in Italics Shaded text are Optional*

## ELECTRICAL CHARACTERISTICS - NQ15W50SGA30 Series

T<sub>A</sub>=25°C, airflow rate=300 LFM, V<sub>in</sub>=12Vdc unless otherwise noted; full operating temperature range is -40°C to +105°C ambient temperature with appropriate power derating. Specifications subject to change without notice.

Parameter	Module	Min.	Typ.	Max.	Units	Notes & Conditions
<b>ABSOLUTE MAXIMUM RATINGS</b>						
Input Voltage						
Non-Operating	All	0		16	V	Continuous
Operating	All			15	V	Continuous
Operating Temperature	All	-40		105	°C	
Storage Temperature	All	-55		125	°C	
Voltage at ON/OFF input pin	All	-3		15	V	
<b>RECOMMENDED OPERATING CONDITIONS</b>						
Input Voltage Range	All	6		15	V	
Input Fuse Rating	All			40	A	Fast blow external fuse recommended
External Input Capacitance	All	100			µF	ESR<1.5Ω
Output Voltage	All	0.8		5.0	V	
Output Current	All	0		30	A	
<b>INPUT CHARACTERISTICS</b>						
Input Under-Voltage Lockout						
Turn-On Voltage Threshold	All	5.20	5.60	6.00	V	
Turn-Off Voltage Threshold	All	4.60	5.00	5.40	V	
Lockout Hysteresis	All		0.6		V	
Maximum Input Current	1.8V			6.0	A	6Vin, 100% load
"	3.3V			18.0	A	"
"	5.0V			28.0	A	"
No-Load Input Current	1.8V		102		mA	12Vin, 100% load
"	3.3V		156		mA	"
"	5.0V		232		mA	"
Disabled Input Current	All		3		mA	
Inrush Current Transient Rating	All			0.1	A <sup>2</sup> s	With min. output capacitance
Input Filter Capacitor Value	All		20		µF	
Input Reflected-Ripple Current	1.0V		36		mA	12Vin, 100% load, pk-pk value
"	2.5V		68		mA	"
"	5.0V		98		mA	"
<b>OUTPUT CHARACTERISTICS</b>						
Output Voltage Set Point	0.8V	0.790	0.800	0.810	V	12Vin 50% load
Output Voltage Range	All	0.8		5.5	V	Set output by Rtrim-up
Operating Output Current Range	All	0		30	A	
Output Voltage Regulation						
Over Line	All			0.5	%	With sense pin
Over Load	All			0.6	%	"
Over Temperature	All			1	%	"
Total Output Voltage Range	All			3	%	With sense pin, over sample, line, load, temp. & life
Output Voltage Ripple and Noise (pk-pk\RMS)	1.0V		27\5.0		mV	Full load; 20MHz bandwidth
"	2.5V		43\11.6		mV	"
"	5.0V		67\20.4		mV	"
Output DC Over Current Shutdown	All	33	40	47	A	
External Output Capacitance	All	100		10,000	µF	>1mΩ
<b>DYNAMIC CHARACTERISTICS</b>						
Input Voltage Ripple Rejection	All		50		dB	120Hz
Output Voltage during Current Transient						
For a Step Change in Output Current (0.1A/µs)	All		250		mV	50%-75%-50% Iout max; 100µF
For a Step Change in Output Current (3A/µs)	All		250		mV	50%-75%-50% Iout max; 470µF
Settling Time	All		100		µs	To within 1.5% Vout nom.
Turn on Transient						
Inhibit Time	All	2		4	ms	Resistive load
Rise Time	All	4		8	ms	"
Output Voltage Overshoot	All			0	V	"
<b>EFFICIENCY</b>						
100% Load	1.8V		85.0		%	
"	3.3V		90.0		%	
"	5.0V		93.0		%	
50% Load	1.8V		86.0		%	
"	3.3V		91.0		%	
"	5.0V		93.0		%	

## ELECTRICAL CHARACTERISTICS (continued) - NQ15W50SGA30 Series

Parameter	Module	Min.	Typ.	Max.	Units	Notes & Conditions
<b>TEMP LIMITS FOR POWER DERATING</b>						
Semiconductor Junction Temperature	All			125	°C	Package rated to 150°C
Board Temperature	All			125	°C	UL rated max operating temp 130°C
<b>FEATURE CHARACTERISTICS</b>						
Switching Frequency	All	330	360	390	kHz	Half on small duty cycle (e.g. 16Vin; 0.75Vout)
ON/OFF Control						
Negative Logic (N) ON/OFF Control						See Figure A
Off-State Voltage	All	1.5		6.5	V	
On-State Voltage	All	-3.0		0.6	V	
Pull-Up Voltage	All		V <sub>in</sub>		V	
Pull-Up Resistance	All		49.9		kΩ	
Positive Logic (P) ON/OFF Control						Open collector/drain input; see Figure A
Logic Low Voltage Range	All	-0.2		1.0	V	
Logic High Voltage Range (internal pullup)	All	2.2			V	
Logic Low Sink Current	All		0.7		mA	V <sub>in</sub> = 15 V
Logic High Sink Current (leakage)	All			10	μA	
Output Voltage Trim Range	All	0.75		5.5	V	Measured V <sub>out+</sub> to common pins
Output Over-Voltage Protection	All	5.6	6.0	6.4	V	Over full temp range
Over-Temperature Shutdown	All		128		°C	Average PCB Temperature
Over-Temperature Shutdown Restart Hysteresis	All		10		°C	
<b>RELIABILITY CHARACTERISTICS</b>						
Calculated MTBF (Telcordia)	All		14.0		10 <sup>6</sup> Hrs.	TR-NWT-000332; 100% load, 200LFM, 40°C T <sub>a</sub>
Calculated MTBF (MIL-217)	All		10.8		10 <sup>6</sup> Hrs.	MIL-HDBK-217F; 100% load, 200LFM, 40°C T <sub>a</sub>
Field Demonstrated MTBF	All				10 <sup>6</sup> Hrs.	See our website for details

## STANDARDS COMPLIANCE

Parameter	Notes
<b>STANDARDS COMPLIANCE</b>	
UL/cUL 60950-1	File # E194341
EN60950-1	Certified by TÜV
72/23/EEC	
93/68/EEC	
Needle Flame Test (IEC 695-2-2)	Test on entire assembly; board & plastic components UL94V-0 compliant
IEC 61000-4-2	ESD test, 8kV - NP, 15kV air - NP (Normal Performance)
GR-1089-CORE	Section 7 - electrical safety, Section 9 - bonding/grounding
Telcordia (Bellcore) GR-513	

- An external input fuse must always be used to meet these safety requirements. Contact SynQor for official safety certificates on new releases or download from the SynQor website.

## QUALIFICATION TESTING

Parameter	# Units	Test Conditions
<b>QUALIFICATION TESTING</b>		
Life Test	32	95% rated V <sub>in</sub> and load, units at derating point, 1000 hours
Vibration	5	10-55Hz sweep, 0.060" total excursion, 1 min./sweep, 120 sweeps for 3 axis
Mechanical Shock	5	100g minimum, 2 drops in x and y axis, 1 drop in z axis
Temperature Cycling	10	-40°C to 100°C, unit temp. ramp 15°C/min., 500 cycles
Power/Thermal Cycling	5	T <sub>operating</sub> = min to max, V <sub>in</sub> = min to max, full load, 100 cycles
Design Marginality	5	T <sub>min</sub> -10°C to T <sub>max</sub> +10°C, 5°C steps, V <sub>in</sub> = min to max, 0-105% load
Humidity	5	85°C, 85% RH, 1000 hours, continuous V <sub>in</sub> applied except 5min./day
Solderability	15 pins	MIL-STD-883, method 2003

- Extensive characterization testing of all SynQor products and manufacturing processes is performed to ensure that we supply robust, reliable product. Contact the factory for official product family qualification documents.

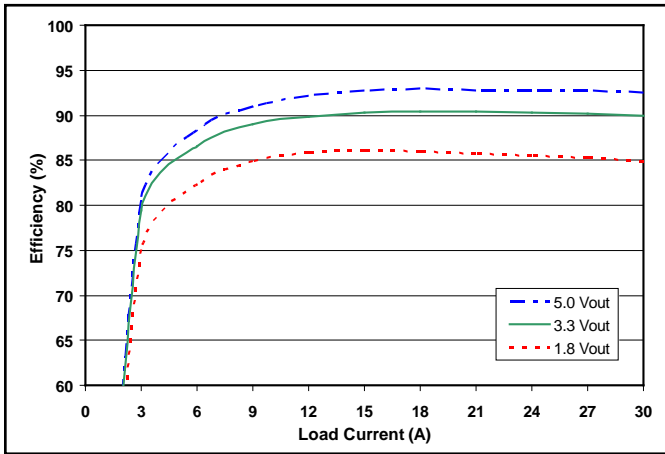

Figure 1: Efficiency at nominal output voltage vs. load current for nominal input voltage at 25°C.

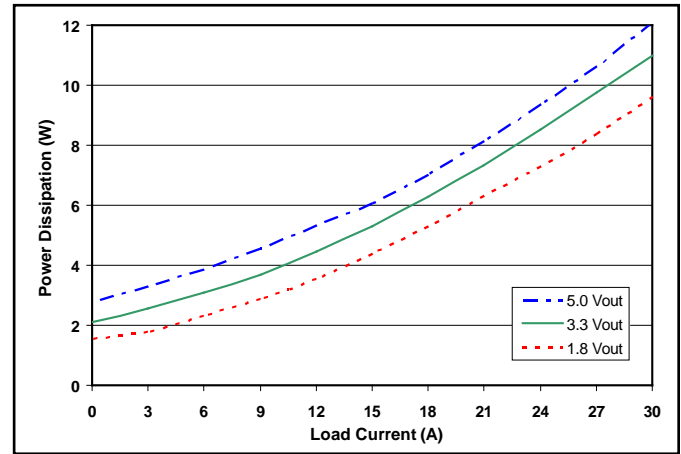

Figure 2: Power dissipation at nominal output voltage vs. load current for nominal input voltage at 25°C.

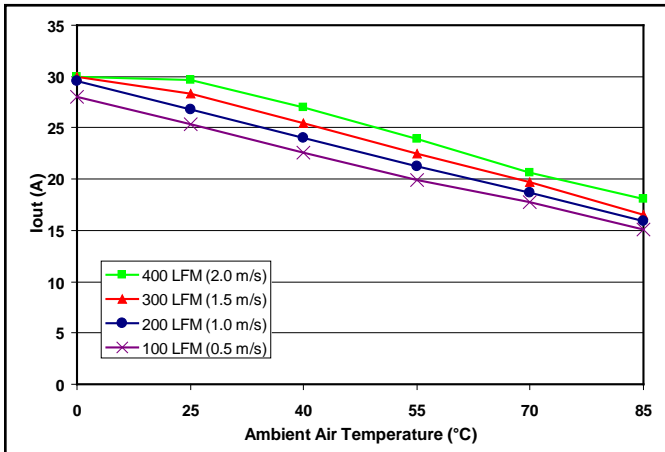

Figure 3: Maximum output power derating curves with nominal output set to 1.8Vo units under various thermal conditions and nominal input voltage (P option, see ordering page).

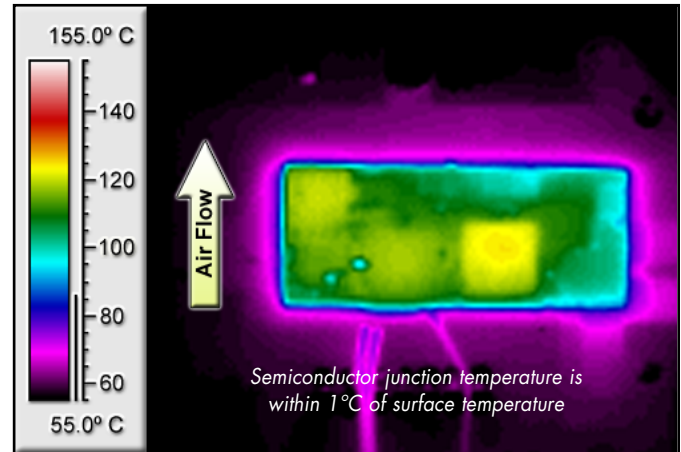

Figure 4: Thermal plot of the converter with nominal Vout set to 1.8Vo at nominal Vin and 21.2 amp load current mounted on a 55°C, 200 LFM, 6-Layer, 2 oz. copper board (typical installation).

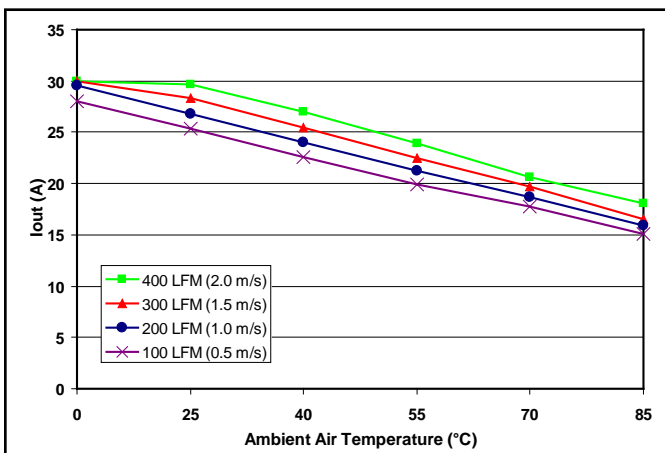

Figure 5: Maximum output power derating curves with nominal output set to 3.3Vo units under various thermal conditions and nominal input voltage (P option, see ordering page).

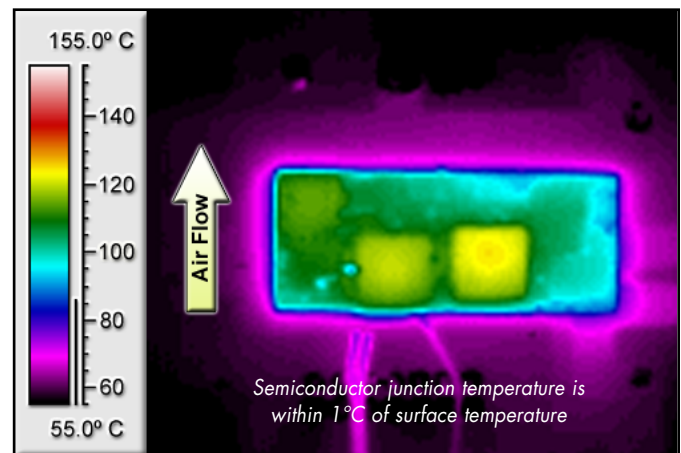
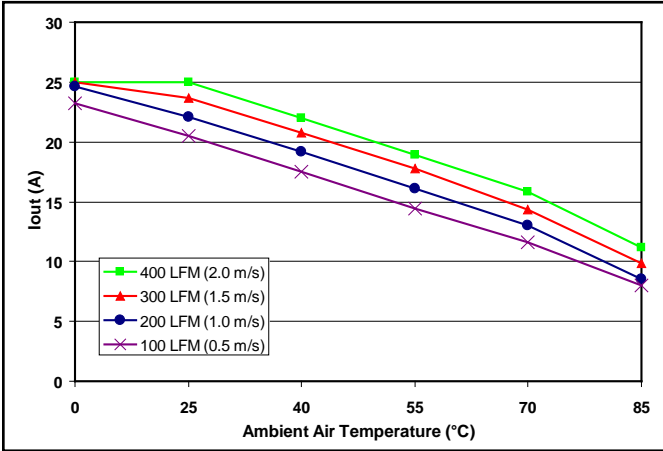
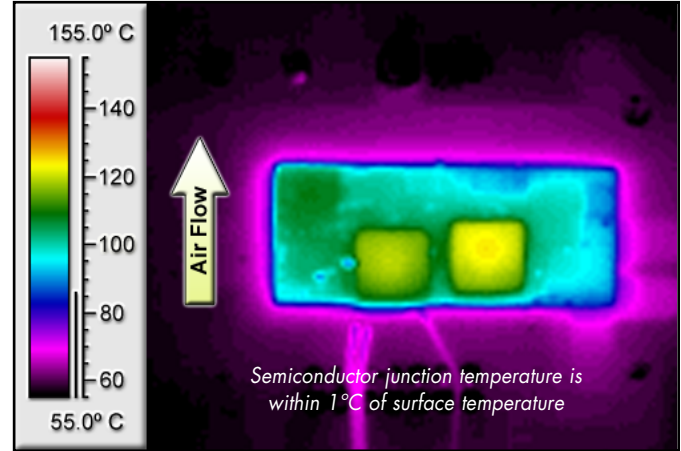

Figure 6: Thermal plot of the converter with nominal Vout set to 3.3Vo at nominal Vin and 18.4 amp load current mounted on a 55°C, 200 LFM, 6-Layer, 2 oz. copper board (typical installation).



**Figure 7:** Maximum output power derating curves with nominal output set to 5.0Vo units under various thermal conditions and nominal input voltage (P option, see ordering page).



**Figure 8:** Thermal plot of the converter with nominal V<sub>out</sub> set to 5.0Vo at nominal V<sub>in</sub> and 16.1 amp load current mounted on a 55°C, 200 LFM, 6-Layer, 2 oz. copper board (typical installation).

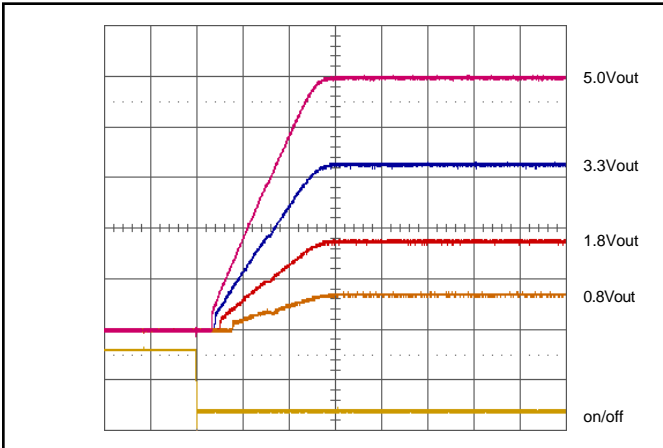

**Figure 9:** Turn-on transient at full load (resistive load) (2 ms/div).  
 Ch 1: ON/OFF input (5V/div)  
 Ch 2-4: V<sub>out</sub> (1V/div)

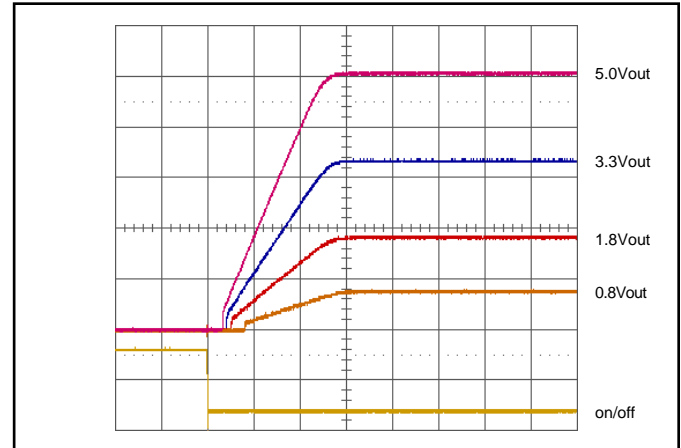

**Figure 10:** Turn-on transient at zero load (2 ms/div).  
 Ch 1: ON/OFF input (5V/div)  
 Ch 2-4: V<sub>out</sub> (1V/div)

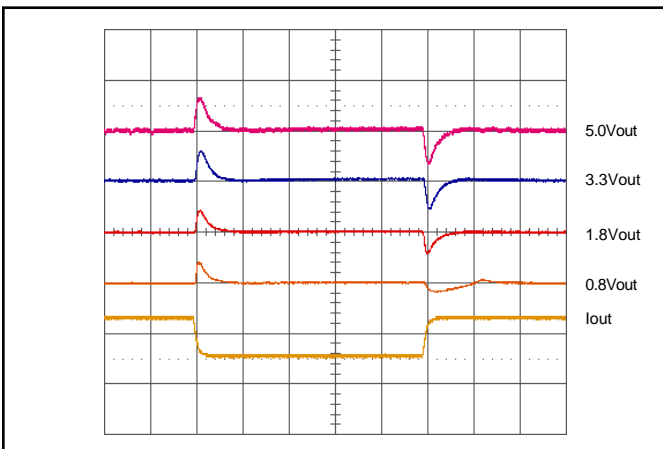

**Figure 11:** Output voltage response for 1.5V, 2.5V, 5V units to step-change in load current (50-75-50% of I<sub>out</sub> max; di/dt=0.1A/μs). Load cap: 100 μF, 100mΩ ESR tant, 22 μF cer. Ch 1: I<sub>out</sub> (10A/div), Ch 2-4: V<sub>out</sub> (100mV/div).

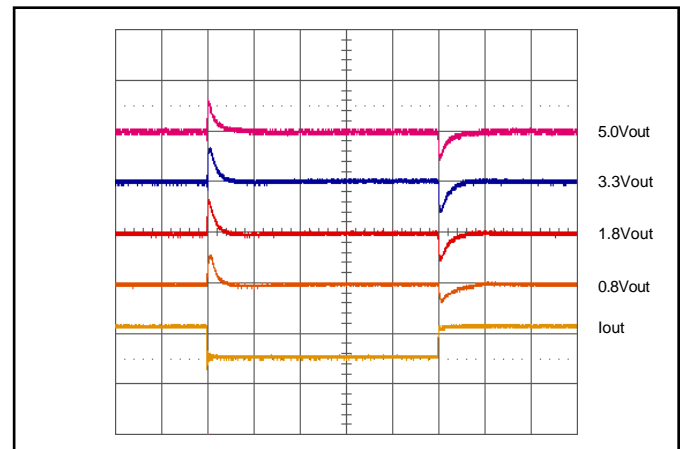

**Figure 12:** Output voltage response for 1.5V, 2.5V, 5V units to step-change in load current (50-75-50% of I<sub>out</sub> max; di/dt=3A/μs). Load cap: 100 μF, 100mΩ ESR tant, 22 μF cer. Ch 1: I<sub>out</sub> (10A/div), Ch 2-4: V<sub>out</sub> (100mV/div).

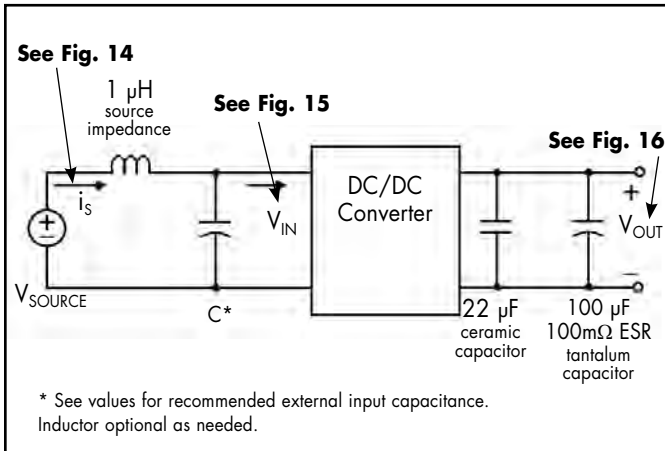

**Figure 13:** Test set-up diagram showing measurement points for Input Reflected Ripple Current (Figure 14), Input Terminal Ripple Voltage (Figure 15), and Output Voltage Ripple (Figure 16).

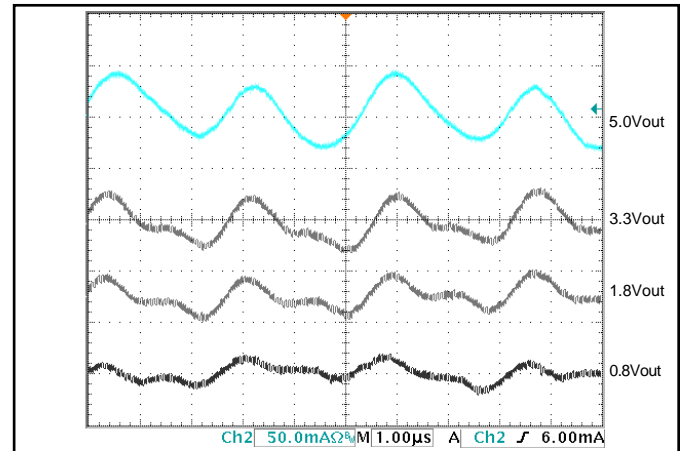

**Figure 14:** Input Reflected Ripple Current,  $i_s$ , through a 1  $\mu$ H source inductor at nominal input voltage and rated load current (100 mA/div). See Figure 13.

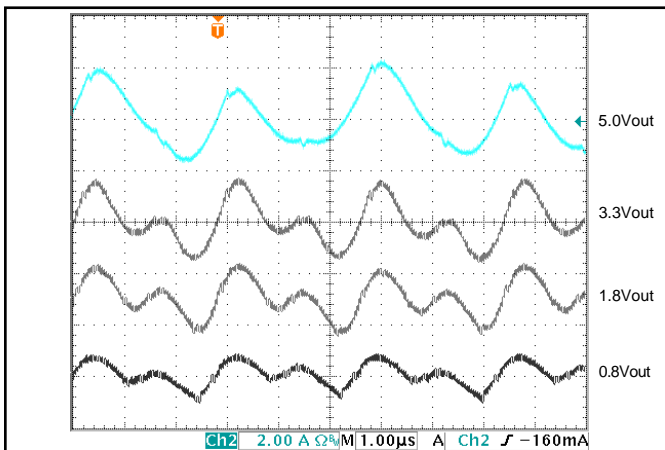

**Figure 15:** Input Terminal Ripple Voltage at nominal input voltage and rated load current (200 mV/div). Load capacitance: 22  $\mu$ F ceramic cap and 100  $\mu$ F tantalum cap. Bandwidth: 20 MHz. See Figure 13.

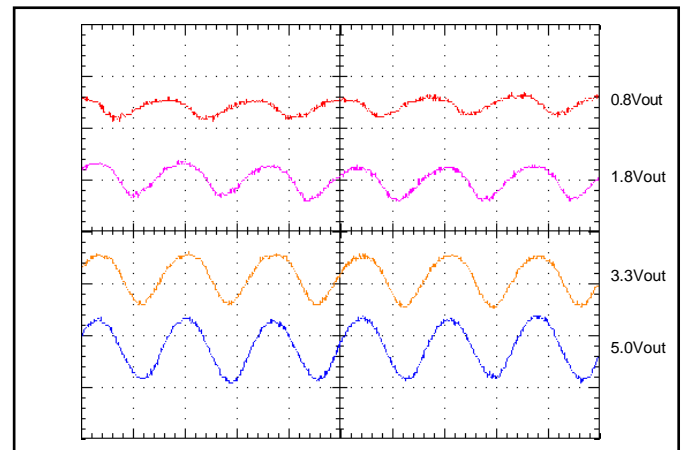

**Figure 16:** Output Voltage Ripple at nominal input voltage and rated load current (50 mV/div). Load capacitance: 22  $\mu$ F ceramic cap and 100  $\mu$ F tantalum cap. Bandwidth: 20 MHz. See Figure 13.

### BASIC OPERATION AND FEATURES

The NiQor series non-isolated converter uses a buck-converter that keeps the output voltage constant over variations in line, load, and temperature. The NiQor modules employ synchronous rectification for very high efficiency.

Dissipation throughout the converter is so low that it does not require a heatsink or metal baseplate for operation. The NiQor converter can thus be built more simply and reliably using high yield surface mount techniques on a single PCB substrate.

The NiQor series of SIPs and SMT converters uses the established industry standard footprint and pin-out configurations.

### CONTROL FEATURES

**REMOTE ON/OFF:** The ON/OFF input permits the user to control when the converter is on or off. There are currently two options available for the ON/OFF input described in the table below. Others may become available if demand exists.

Option	Description	Pin-Open Float Voltage	Pin-Open Converter State	Pin Action
P Logic	Positive/Open	V <sub>in</sub>	On	Pull Low = Off
N Logic	Negative	V <sub>in</sub>	Off	Pull Low = On

**OUTPUT VOLTAGE TRIM:** The TRIM input permits the user to adjust the output voltage according to the trim range specifications by using an external resistor. If the TRIM feature is not being used, leave the TRIM pin disconnected.

**TRIM-UP:** To increase the output voltage from the nominal setpoint of 0.8V using an external resistor, connect the resistor R<sub>trim-up</sub> between the TRIM and the Ground pin according to the diagram below.

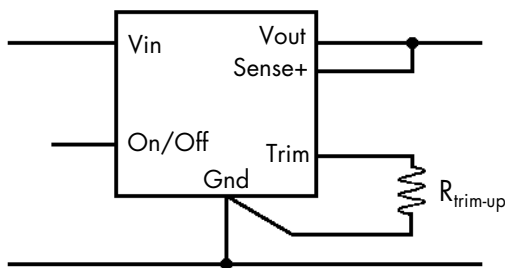

For a desired increase of the nominal output voltage, the value of the resistor should be:

$$R_{\text{trim-up}} = \frac{1200}{V_{\text{DES}} - 0.8} - 100 \ (\Omega)$$

or

$$V_{\text{OUT}} = 0.8 + \frac{1200}{R_{\text{trim-up}} + 100} \ (\Omega)$$

where V<sub>DES</sub> = Desired Output Voltage

To maintain the accuracy of the output voltage over load current, it is vital that any trim-up resistor be terminated directly to the converter's ground foot, not at the connection to the load. A separate Kelvin connection to the PCB pad for the ground foot is optimal. Trim-down resistors should be terminated at the converter's Sense+ pin.

We do not recommend bypassing the trim pin directly to ground with a capacitor. The voltage gain from the trim pin to output is rather large, 15:1. Ground bounce through a bypass capacitor could introduce significant noise to the converter's control circuit.

### PROTECTION FEATURES

**Input Under-Voltage Lockout:** The converter is designed to turn off when the input voltage is too low, helping avoid an input system instability problem, described in more detail in the application note titled "Input System Instability". The lockout circuitry is a comparator with DC hysteresis. When the input voltage is rising, it must exceed the typical Turn-On Voltage Threshold value (listed on the specification page) before the converter will turn on. Once the converter is on, the input voltage must fall below the typical Turn-Off Voltage Threshold value before the converter will turn off.

**Output Current Limiting:** To provide protection in an output over load fault condition, the unit is equipped with internal over-current protection. When the over-current protection is triggered, the unit enters hiccup mode. The units operate normally once the fault condition is removed.

**Internal Over-Voltage Protection:** To fully protect from excessive output voltage, this series contains contains an Output Over-Voltage Shutdown circuitry. This OVP is independent of the trimmed setpoint. As such, the converter's load is protected from faults in the external trim circuitry (such as a trim pin shorted to ground). Since the setpoint of this OVP does not track trim, it is set at 6.0V. For more detailed information contact SynQor technical support.



**Over-Temperature Shutdown:** A temperature sensor on the converter senses the average temperature of the module. The thermal shutdown circuit is designed to turn the converter off when the temperature at the sensed location reaches the Over-Temperature Shutdown value. It will allow the converter to turn on again when the temperature of the sensed location falls by the amount of the Over-Temperature Shutdown Restart Hysteresis value.

## APPLICATION CONSIDERATIONS

**Input Filtering/Capacitance/Damping:** The filter circuit of Figure E is often added to the converter's input to prevent switching noise from reaching the input voltage bus.

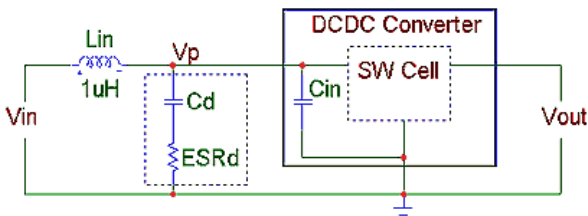

**Figure E:** converter with Input Filter

In the SGA30 (surface mount) converters  $C_{in} = 20\mu\text{F}$  of high quality ceramic capacitors. With  $L_{in}$  of  $1\mu\text{H}$ ,  $C_d$  should be  $100\text{-}200\mu\text{F}$  and  $R_d$  should be  $0.1\text{-}0.2\Omega$ , in most applications. For more information on designing the input filter and choosing proper values, contact SynQor technical support.

Adding significant external pure ceramic capacitance directly across the converter's input pins is not recommended. Parasitic inductance associated with the input pin geometry and PCB traces can create a high-Q CLC circuit with any external capacitors. Just a few nano-Henries of parasitic inductance can create a resonance (or an overtone) near the converter's switching frequency. To avoid this high-frequency resonance, any external input filter should exhibit a net source impedance of at least  $20\text{m}\Omega$  resistive through this frequency range. This requirement is easily met with the damping elements discussed above. Adding a small amount (a few  $\mu\text{F}$ ) of high-frequency external ceramic will not violate it.

If using converters at higher powers, consider the ripple current rating of  $C_d$ . Contact SynQor technical support for details.

**Output Capacitance:** It is recommended to add at least  $100\mu\text{F}$  of capacitance, with an ESR in the  $0.1\Omega$  range, to the output of the SGA30 series of converters. In many applications, however, additional external output capacitance is required to reduce the response to load transients to an allowable level.

For minimal overshoot upon recovery,  $C_d$  should be related to the minimum in-circuit net ESR.

For more detailed derivations of these values contact SynQor technical support.

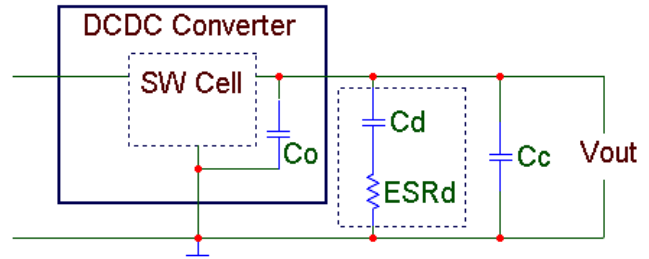

**Figure H:** Converter with Additional Output Capacitance

**Active Load Sharing:** For additional power requirements, the SGA30 series of converters have a parallel feature available. To implement forced load sharing, the following connections should be made:

- The share pins of all units in parallel must be connected together. The path of these connections should be as direct as possible.
- All ON/OFF pins should be connected together.

The share bus is not designed for redundant operation and the system will be non-functional upon failure of one of the units when multiple units are in parallel. When not using the parallel feature, leave the share pin open.

## SURFACE MOUNT INFORMATION

**PCB Layout Considerations:** SynQor recommends that the customer use a non-solder mask defined pad design. The minimum recommended pad size is  $0.074" \times 0.122"$  ( $1.88\text{mm} \times 3.1\text{mm}$ ) and the maximum pad size is  $0.095" \times 0.140"$  ( $2.41\text{mm} \times 3.56\text{mm}$ ), see the mechanical diagram on page 2. Interconnection to internal power planes is typically required. This can be accomplished by placing a number of vias between the SMT pad and the relevant plane. The number and location of the vias should be determined based on electrical resistance, current and thermal requirements. "Via-in-pad" design should be avoided in the SMT pads. Solder mask should be used to eliminate solder wicking into the vias.

**Pick and Place:** The NiQor surface mount modules are designed for automated assembly using standard SMT pick and place equipment. The modules have a centrally located inductor component with a flat surface area to be used for component pick-up. The units use open frame construction and have a low mass that is within the capability of standard pick and place equipment. Those modules however have a larger mass than most conventional SMT components and so variables such as nozzle size, tip style, handling speed, and placement pressure should be optimized for best results. A conformal tipped placement nozzle design is recommended. Coplanarity of better than  $0.004"$  ( $0.1\text{mm}$ ) is achieved through the SMT NiQor's terminal design.

**Reflow Soldering Guidelines:** Figure J shows a typical reflow profile for a eutectic solder process. Due to variations in customer applications, materials and processes, it is not feasible for SynQor to recommend a specific reflow profile. The customer should use this profile as a guideline only. Since the NiQor surface mount modules have a larger thermal mass and lower thermal resistance than standard SMT components, it may be necessary to optimize the solder reflow profile based on limitations of the other components on the customer board. Sufficient reflow time must be allowed to fuse the plating on the connection to ensure a reliable solder joint. The solder reflow profile should be confirmed by accurately measuring the SMT interconnect leads. Maximum case temperature of 260°C (exposure for 5 seconds or less) is not exceeded for the NiQor units.

**Moisture Sensitivity:** The NiQor surface mount modules have an MSL rating 1 per IPC/JEDEC J-STD-033A.

**Cleaning and Drying:** When possible, a no-clean solder paste system should be used to solder the NiQor SMT units to their application board. The modules are suitable for aqueous washing, however, the user must ensure sufficient drying to remove all water from the converter before powering up. Inadequate cleaning and drying can affect the reliability of the converter and the testing of the final assembly.

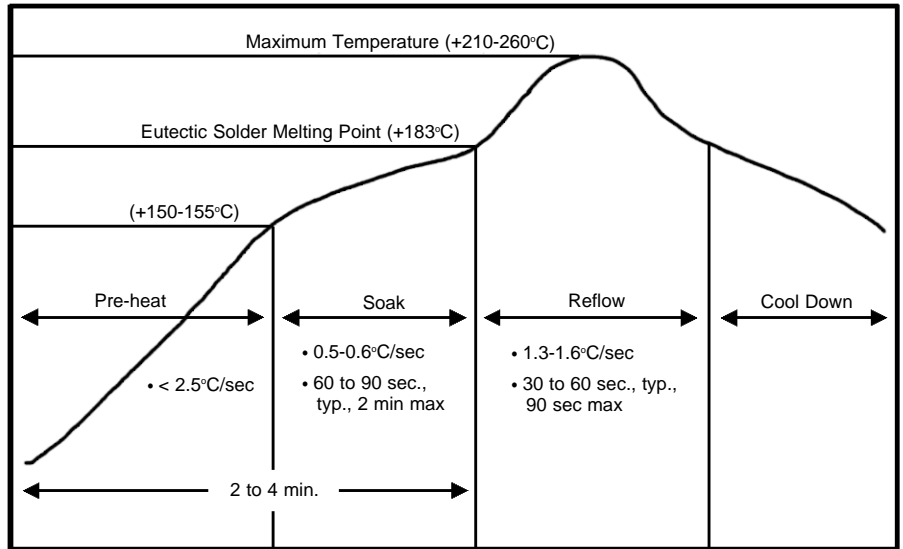

**Figure J:** Typical Eutectic (96.5Sn/3.0Ag/0.5Cu) Solder Profile



# Technical Specification

**Input:** 6.0 - 15.0V  
**Outputs:** 0.8 - 5.0V  
**Current:** 30A  
**Package:** SMT

## PART NUMBERING SYSTEM

The part numbering system for SynQor's dc-dc converters follows the format shown in the example below.

**NQ 15 W50 S G A 30 P S D - G**

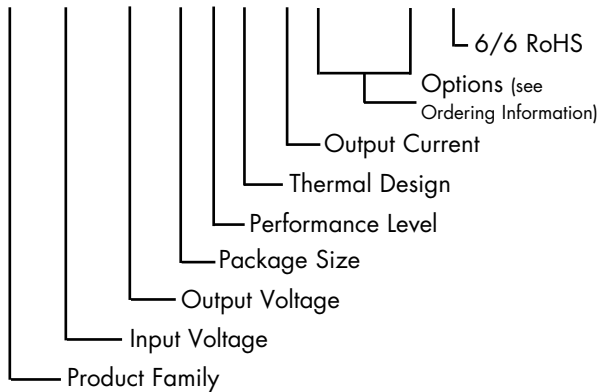

The first 12 characters comprise the base part number and the last 3 characters indicate available options. The "-G" suffix indicates 6/6 RoHS compliance.

## Application Notes

A variety of application notes and technical white papers can be downloaded in pdf format from our website.

**RoHS Compliance:** The EU led RoHS (Restriction of Hazardous Substances) Directive bans the use of Lead, Cadmium, Hexavalent Chromium, Mercury, Polybrominated Biphenyls (PBB), and Polybrominated Diphenyl Ether (PBDE) in Electrical and Electronic Equipment. This SynQor product is 6/6 RoHS compliant. For more information please refer to SynQor's RoHS addendum available at our RoHS Compliance / Lead Free Initiative web page or e-mail us at rohs@synqor.com.

## Contact SynQor for further information:

**Phone:** 978-849-0600  
**Toll Free:** 888-567-9596  
**Fax:** 978-849-0602  
**E-mail:** power@synqor.com  
**Web:** www.synqor.com  
**Address:** 155 Swanson Road  
 Boxborough, MA 01719  
 USA

## ORDERING INFORMATION

The tables below show the valid model numbers and ordering options for converters in this product family. When ordering SynQor converters, please ensure that you use the complete 15 character part number consisting of the 12 character base part number and the additional 3 characters for options. A "-G" suffix indicates the product is 6/6 RoHS compliant.

Model Number	Input Voltage	Output Voltage	Max Output Current
NQ15W50SGA30xyz-G	6.0 - 15 V	0.8 - 5.0 V	30 A

The following options must be included in place of the x y z spaces in the model numbers listed above.

Options Description: x y z		
Enable Logic	Pin Style	Feature Set
N - Negative P - Pos/Open	S - Standard	D - Sense, Share G - Sense, Share, GND pins

Not all combinations make valid part numbers, please contact SynQor for availability.

## PATENTS

SynQor holds the following patents, one or more of which might apply to this product:

5,999,417	6,222,742	6,545,890	6,577,109
6,594,159	6,731,520	6,894,468	6,896,526
6,927,987	7,050,309	7,072,190	7,085,146
7,119,524	7,269,034	7,272,021	7,272,023

### Warranty

SynQor offers a two (2) year limited warranty. Complete warranty information is listed on our website or is available upon request from SynQor.

Information furnished by SynQor is believed to be accurate and reliable. However, no responsibility is assumed by SynQor for its use, nor for any infringements of patents or other rights of third parties which may result from its use. No license is granted by implication or otherwise under any patent or patent rights of SynQor.