

### WIDE BAND SPDT SWITCH

#### DESCRIPTION

The  $\mu$ PD5713TK is a CMOS MMIC for wide band SPDT (Single Pole Double Throw) switch which were developed for mobile communications, wireless communications and another general-purpose RF switching application.

This device can operate frequency from 0.05 to 2.5 GHz, having the low insertion loss and high isolation.

This device is housed in a 6-pin lead-less minimold (1511) package. And this package is able to high-density surface mounting.

#### FEATURES

- Supply voltage :  $V_{DD} = 1.8$  to  $3.6$  V (2.8 V TYP.)
- Switch control voltage :  $V_{cont(H)} = 1.8$  to  $3.6$  V (2.8 V TYP.)  
:  $V_{cont(L)} = -0.2$  to  $+0.4$  V (0 V TYP.)
- Low insertion loss :  $L_{ins1} = 0.6$  dB TYP. @  $f = 0.05$  to  $1.0$  GHz,  $V_{DD} = 2.8$  V,  $V_{cont(H)} = 2.8$  V,  $V_{cont(L)} = 0$  V  
:  $L_{ins2} = 0.8$  dB TYP. @  $f = 1.0$  to  $2.0$  GHz,  $V_{DD} = 2.8$  V,  $V_{cont(H)} = 2.8$  V,  $V_{cont(L)} = 0$  V  
:  $L_{ins3} = 0.95$  dB TYP. @  $f = 2.0$  to  $2.5$  GHz,  $V_{DD} = 2.8$  V,  $V_{cont(H)} = 2.8$  V,  $V_{cont(L)} = 0$  V
- High isolation :  $ISL1 = 32.5$  dB TYP. @  $f = 0.05$  to  $1.0$  GHz,  $V_{DD} = 2.8$  V,  $V_{cont(H)} = 2.8$  V,  $V_{cont(L)} = 0$  V  
:  $ISL2 = 25$  dB TYP. @  $f = 1.0$  to  $2.0$  GHz,  $V_{DD} = 2.8$  V,  $V_{cont(H)} = 2.8$  V,  $V_{cont(L)} = 0$  V  
:  $ISL3 = 22.5$  dB TYP. @  $f = 2.0$  to  $2.5$  GHz,  $V_{DD} = 2.8$  V,  $V_{cont(H)} = 2.8$  V,  $V_{cont(L)} = 0$  V
- Handling power :  $P_{in(1\text{ dB})} = +21.0$  dBm TYP. @  $f = 1.0$  GHz,  $V_{DD} = 2.8$  V,  $V_{cont(H)} = 2.8$  V,  $V_{cont(L)} = 0$  V  
:  $P_{in(0.1\text{ dB})} = +17.0$  dBm TYP. @  $f = 1.0$  GHz,  $V_{DD} = 2.8$  V,  $V_{cont(H)} = 2.8$  V,  $V_{cont(L)} = 0$  V
- High-density surface mounting : 6-pin lead-less minimold package ( $1.5 \times 1.1 \times 0.55$  mm)

#### APPLICATIONS

- Mobile communications
- Wireless communications
- Another general-purpose RF switching applications

#### ORDERING INFORMATION

Part Number	Order Number	Package	Marking	Supplying Form
$\mu$ PD5713TK-E2	$\mu$ PD5713TK-E2-A	6-pin lead-less minimold (1511) (Pb-Free)	C3Q	<ul style="list-style-type: none"> <li>• Embossed tape 8 mm wide</li> <li>• Pin 1, 6 face the perforation side of the tape</li> <li>• Qty 5 kpcs/reel</li> </ul>

**Remark** To order evaluation samples, contact your nearby sales office.  
Part number for sample order:  $\mu$ PD5713TK

**Caution** Observe precautions when handling because these devices are sensitive to electrostatic discharge.

The information in this document is subject to change without notice. Before using this document, please confirm that this is the latest version.  
Not all products and/or types are available in every country. Please check with an NEC Electronics sales representative for availability and additional information.

**PIN CONNECTIONS AND INTERNAL BLOCK DIAGRAM**

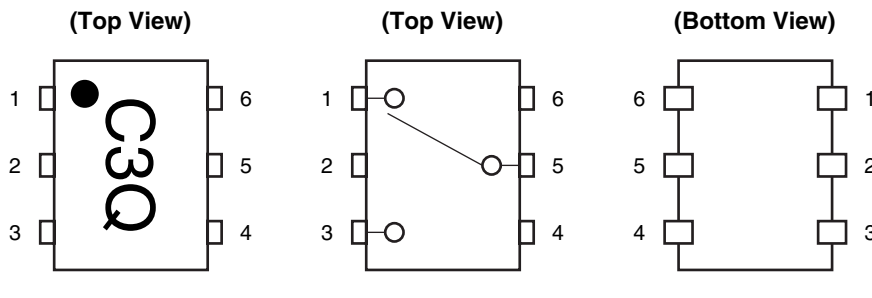

Pin No.	Pin Name
1	OUTPUT1
2	GND
3	OUTPUT2
4	V <sub>cont</sub>
5	INPUT
6	V <sub>DD</sub>

**TRUTH TABLE**

V <sub>cont</sub>	INPUT-OUTPUT1	INPUT-OUTPUT2
Low	OFF	ON
High	ON	OFF

**ABSOLUTE MAXIMUM RATINGS (T<sub>A</sub> = +25°C, unless otherwise specified)**

Parameter	Symbol	Ratings	Unit
Supply Voltage	V <sub>DD</sub>	-0.5 to +4.6	V
Switch Control Voltage	V <sub>cont</sub>	-0.5 to +4.6	V
Voltage Difference	V <sub>cont (H)</sub> - V <sub>DD</sub>	+0.5	V
Input Power	P <sub>in</sub>	+23	dBm
Operating Ambient Temperature	T <sub>A</sub>	-45 to +85	°C
Storage Temperature	T <sub>stg</sub>	-55 to +150	°C

**RECOMMENDED OPERATING RANGE (T<sub>A</sub> = +25°C, unless otherwise specified)**

Parameter	Symbol	MIN.	TYP.	MAX.	Unit
Supply Voltage	V <sub>DD</sub>	+1.8	+2.8	+3.6	V
Switch Control Voltage (H)	V <sub>cont (H)</sub>	+1.8	+2.8	+3.6	V
Switch Control Voltage (L)	V <sub>cont (L)</sub>	-0.2	0	+0.4	V

**Remark** V<sub>DD</sub> - 0.4 V ≤ V<sub>cont (H)</sub> ≤ V<sub>DD</sub> + 0.2 V

**ELECTRICAL CHARACTERISTICS**

( $T_A = +25^{\circ}\text{C}$ ,  $V_{DD} = 2.8\text{ V}$ ,  $V_{\text{cont(H)}} = 2.8\text{ V}$ ,  $V_{\text{cont(L)}} = 0\text{ V}$ , DC cut capacitors = 1 000 pF, unless otherwise specified)

Parameter	Symbol	Test Conditions	MIN.	TYP.	MAX.	Unit
Insertion Loss 1	L <sub>ins1</sub>	f = 0.05 to 1.0 GHz	–	0.6	0.8	dB
Insertion Loss 2	L <sub>ins2</sub>	f = 1.0 to 2.0 GHz	–	0.8	1.0	dB
Insertion Loss 3	L <sub>ins3</sub>	f = 2.0 to 2.5 GHz	–	0.95	1.2	dB
Isolation 1	ISL1	f = 0.05 to 1.0 GHz	30	32.5	–	dB
Isolation 2	ISL2	f = 1.0 to 2.0 GHz	22	25	–	dB
Isolation 3	ISL3	f = 2.0 to 2.5 GHz	20	22.5	–	dB
Input Return Loss	RL <sub>in</sub>	f = 0.05 to 2.5 GHz	13	17	–	dB
Output Return Loss	RL <sub>out</sub>	f = 0.05 to 2.5 GHz	13	17	–	dB
0.1 dB Loss Compression Input Power <sup>Note 1</sup>	P <sub>in (0.1 dB)</sub>	f = 1.0 GHz	+13.0	+17.0	–	dBm
1 dB Loss Compression Input Power <sup>Note 2</sup>	P <sub>in (1 dB)</sub>	f = 1.0 GHz	–	+21.0	–	dBm
Supply Current	I <sub>DD</sub>	V <sub>DD</sub> = V <sub>cont</sub> = 2.8 V, RF off	–	0.01	1.0	μA
Switch Control Current	I <sub>cont</sub>	V <sub>DD</sub> = V <sub>cont</sub> = 2.8 V, RF off	–	0.01	1.0	μA
Switch Control Speed	t <sub>SW</sub>	f = 1.0 GHz	–	30	100	ns

**Notes 1.** P<sub>in (0.1 dB)</sub> is measured the input power level when the insertion loss increases more 0.1 dB than that of linear range.

**2.** P<sub>in (1 dB)</sub> is measured the input power level when the insertion loss increases more 1 dB than that of linear range.

**Caution** This device is used it is necessary to use DC cut capacitors.

The value of DC cut capacitors should be chosen to accommodate the frequency of operation, bandwidth, switching speed and the condition with actual board of your system.

EVALUATION CIRCUIT

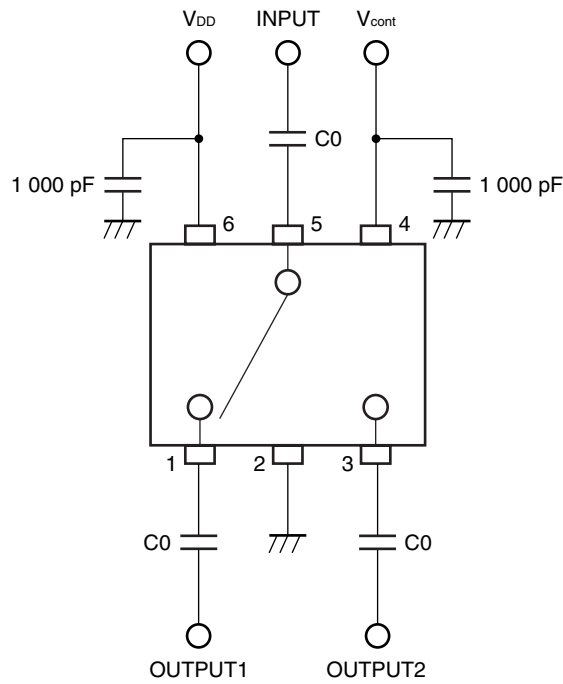

**Remark** C0 = 1 000 pF

**Caution** This IC has pull down resistance between RF line and GND, witch fixes electric potential of RF line to 0 V, then the IC cannot be used for DC switching.

The application circuits and their parameters are for reference only and are not intended for use in actual design-ins.

ILLUSTRATION OF THE TEST CIRCUIT ASSEMBLED ON EVALUATION BOARD

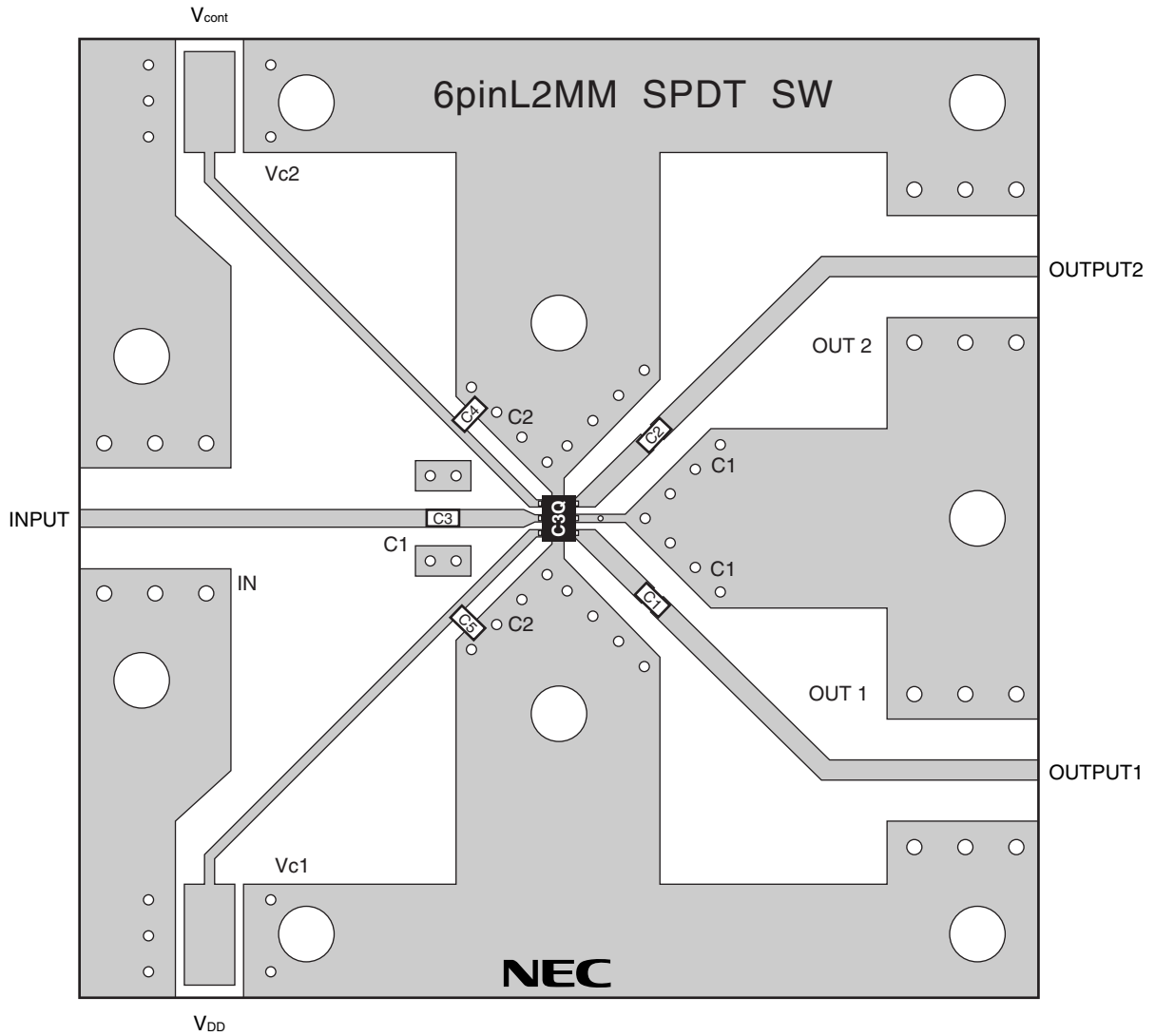

USING THE NEC EVALUATION BOARD

Symbol	Values
C1, C2, C3	1 000 pF
C4, C5	1 000 pF

**TYPICAL CHARACTERISTICS**

( $T_A = +25^\circ\text{C}$ ,  $V_{DD} = 2.8\text{ V}$ ,  $V_{\text{cont}}(\text{H}) = 2.8\text{ V}$ ,  $V_{\text{cont}}(\text{L}) = 0\text{ V}$ ,  $P_{\text{in}} = 0\text{ dBm}$ , DC cut capacitors = 1 000 pF, unless otherwise specified)

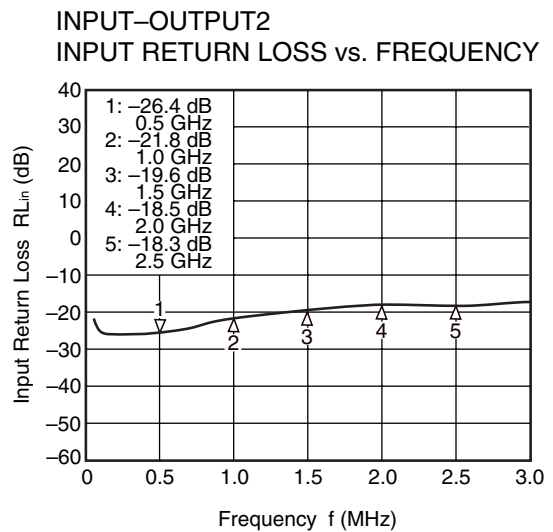
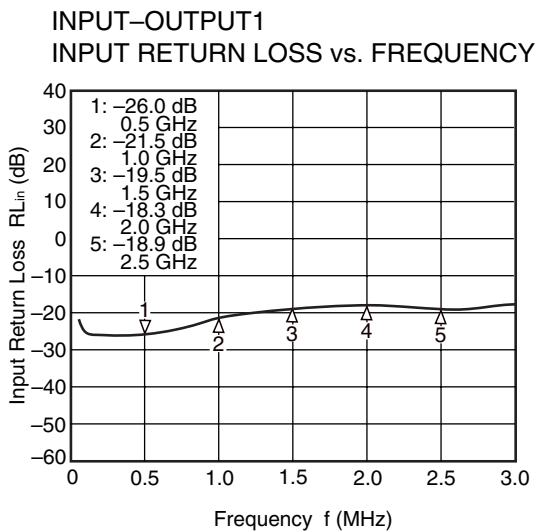
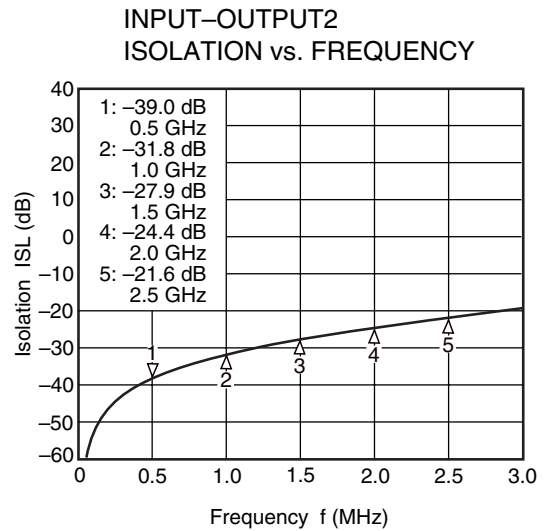
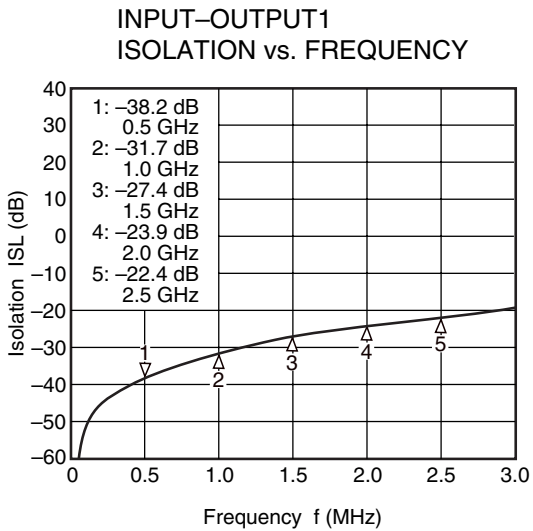
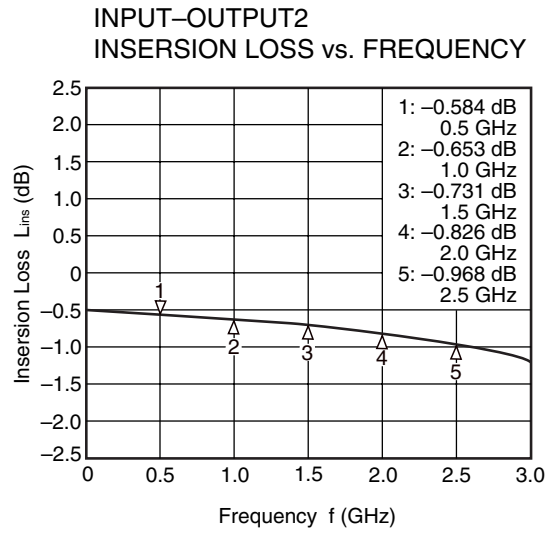
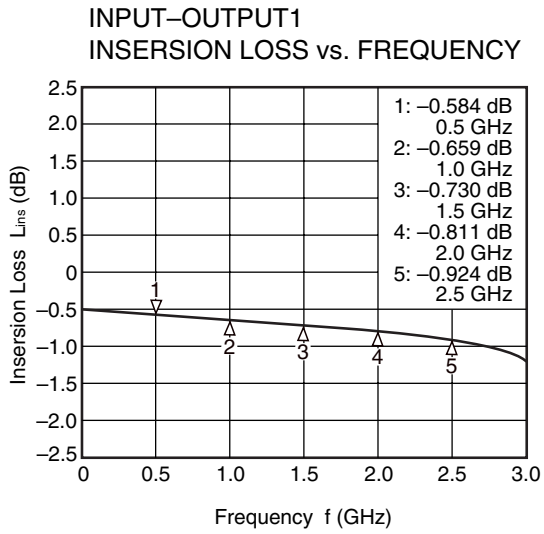

**Remark** The graphs indicate nominal characteristics.

INPUT-OUTPUT1  
OUTPUT RETURN LOSS vs. FREQUENCY

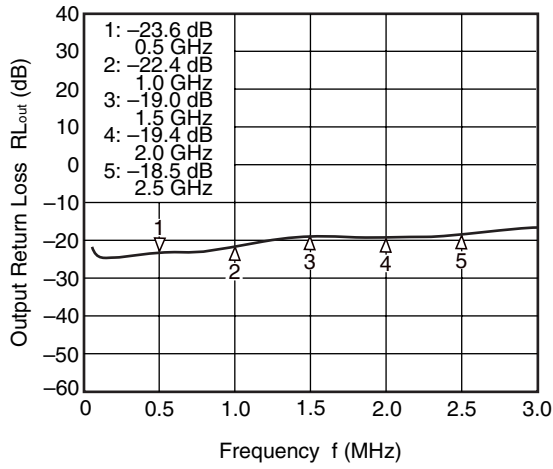

INPUT-OUTPUT2  
OUTPUT RETURN LOSS vs. FREQUENCY

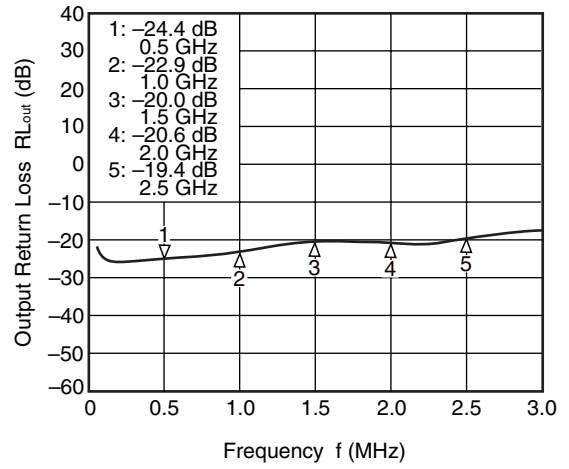

OUTPUT POWER vs. INPUT POWER

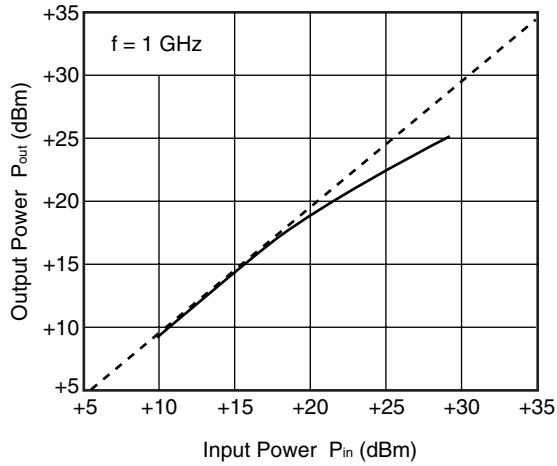

**Remark** The graphs indicate nominal characteristics.

MOUNTING PAD DIMENSIONS

6-PIN LEAD-LESS MINIMOLD (1511) (UNIT: mm)

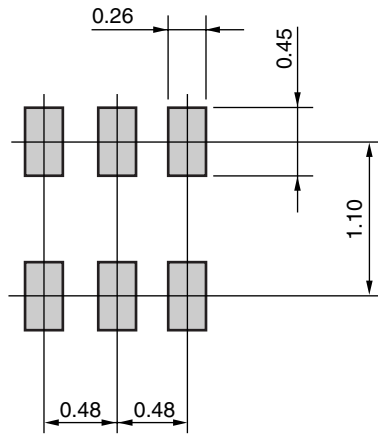

**Remark** The mounting pad layouts in this document are for reference only.



PACKAGE DIMENSIONS

6-PIN LEAD-LESS MINIMOLD (1511) (UNIT: mm)

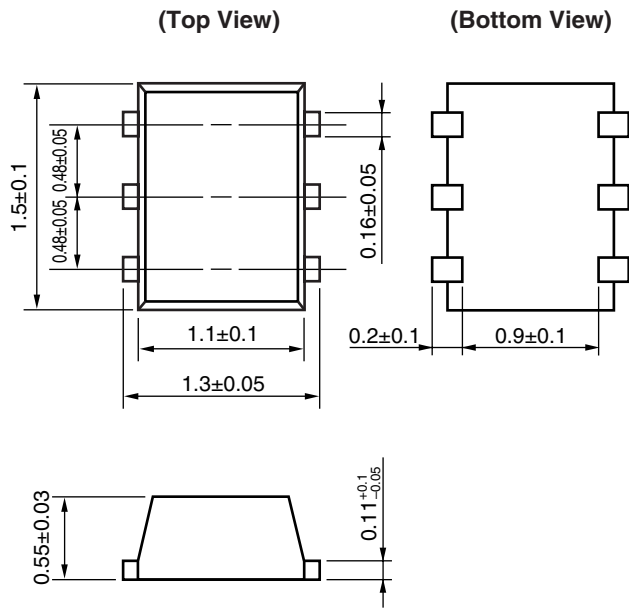

**RECOMMENDED SOLDERING CONDITIONS**

This product should be soldered and mounted under the following recommended conditions. For soldering methods and conditions other than those recommended below, contact your nearby sales office.

Soldering Method	Soldering Conditions	Condition Symbol
Infrared Reflow	Peak temperature (package surface temperature) : 260°C or below Time at peak temperature : 10 seconds or less Time at temperature of 220°C or higher : 60 seconds or less Preheating time at 120 to 180°C : 120±30 seconds Maximum number of reflow processes : 3 times Maximum chlorine content of rosin flux (% mass) : 0.2%(Wt.) or below	IR260
Wave Soldering	Peak temperature (molten solder temperature) : 260°C or below Time at peak temperature : 10 seconds or less Preheating temperature (package surface temperature) : 120°C or below Maximum number of flow processes : 1 time Maximum chlorine content of rosin flux (% mass) : 0.2%(Wt.) or below	WS260
Partial Heating	Peak temperature (terminal temperature) : 350°C or below Soldering time (per side of device) : 3 seconds or less Maximum chlorine content of rosin flux (% mass) : 0.2%(Wt.) or below	HS350

**Caution Do not use different soldering methods together (except for partial heating).**

- **The information in this document is current as of September, 2006. The information is subject to change without notice. For actual design-in, refer to the latest publications of NEC Electronics data sheets or data books, etc., for the most up-to-date specifications of NEC Electronics products. Not all products and/or types are available in every country. Please check with an NEC Electronics sales representative for availability and additional information.**

- No part of this document may be copied or reproduced in any form or by any means without the prior written consent of NEC Electronics. NEC Electronics assumes no responsibility for any errors that may appear in this document.
- NEC Electronics does not assume any liability for infringement of patents, copyrights or other intellectual property rights of third parties by or arising from the use of NEC Electronics products listed in this document or any other liability arising from the use of such products. No license, express, implied or otherwise, is granted under any patents, copyrights or other intellectual property rights of NEC Electronics or others.
- Descriptions of circuits, software and other related information in this document are provided for illustrative purposes in semiconductor product operation and application examples. The incorporation of these circuits, software and information in the design of a customer's equipment shall be done under the full responsibility of the customer. NEC Electronics assumes no responsibility for any losses incurred by customers or third parties arising from the use of these circuits, software and information.
- While NEC Electronics endeavors to enhance the quality, reliability and safety of NEC Electronics products, customers agree and acknowledge that the possibility of defects thereof cannot be eliminated entirely. To minimize risks of damage to property or injury (including death) to persons arising from defects in NEC Electronics products, customers must incorporate sufficient safety measures in their design, such as redundancy, fire-containment and anti-failure features.
- NEC Electronics products are classified into the following three quality grades: "Standard", "Special" and "Specific".

The "Specific" quality grade applies only to NEC Electronics products developed based on a customer-designated "quality assurance program" for a specific application. The recommended applications of an NEC Electronics product depend on its quality grade, as indicated below. Customers must check the quality grade of each NEC Electronics product before using it in a particular application.

"Standard": Computers, office equipment, communications equipment, test and measurement equipment, audio and visual equipment, home electronic appliances, machine tools, personal electronic equipment and industrial robots.

"Special": Transportation equipment (automobiles, trains, ships, etc.), traffic control systems, anti-disaster systems, anti-crime systems, safety equipment and medical equipment (not specifically designed for life support).

"Specific": Aircraft, aerospace equipment, submersible repeaters, nuclear reactor control systems, life support systems and medical equipment for life support, etc.

The quality grade of NEC Electronics products is "Standard" unless otherwise expressly specified in NEC Electronics data sheets or data books, etc. If customers wish to use NEC Electronics products in applications not intended by NEC Electronics, they must contact an NEC Electronics sales representative in advance to determine NEC Electronics' willingness to support a given application.

(Note)

- (1) "NEC Electronics" as used in this statement means NEC Electronics Corporation and also includes its majority-owned subsidiaries.
- (2) "NEC Electronics products" means any product developed or manufactured by or for NEC Electronics (as defined above).

---

► For further information, please contact

**NEC Compound Semiconductor Devices Hong Kong Limited**

E-mail: [contact@ncsd-hk.necel.com](mailto:contact@ncsd-hk.necel.com)

Hong Kong Head Office TEL: +852-3107-7303 FAX: +852-3107-7309

Taipei Branch Office TEL: +886-2-8712-0478 FAX: +886-2-2545-3859

Korea Branch Office TEL: +82-2-558-2120 FAX: +82-2-558-5209

**NEC Electronics (Europe) GmbH** <http://www.eu.necel.com/>

TEL: +49-211-6503-0 FAX: +49-211-6503-1327

**California Eastern Laboratories, Inc.** <http://www.cel.com/>

TEL: +1-408-988-3500 FAX: +1-408-988-0279

**Compound Semiconductor Devices Division**

**NEC Electronics Corporation**

URL: <http://www.ncsd.necel.com/>