

# Distinctive Characteristics

Low profile body of MRF model accommodates space limitations required for PCB mounting. For the MRA and MRK bushing mount models, the range of behind panel body depths is .323" to .669" (8.2mm to 17.0mm).

Positive detent mechanism for distinct feel and audible feedback.

Metal bushing and housing construction increases durability.

Adjustable stopper plate allows 2–12 position settings.

High contact reliability achieved by the self-cleaning contact mechanism.

Break-before-make contact timing with sliding contacts in MRA and rotary contactor disk in MRF and MRK models.

Interior housing seal and molded-in PC terminals, plus shaft rubber o-ring on MRF and MRK and polyamide cover on MRF model, allow cleaning after automated soldering.

Exterior rubber washer and double flatted bushing on MRA and MRK give protection in splashproof applications.

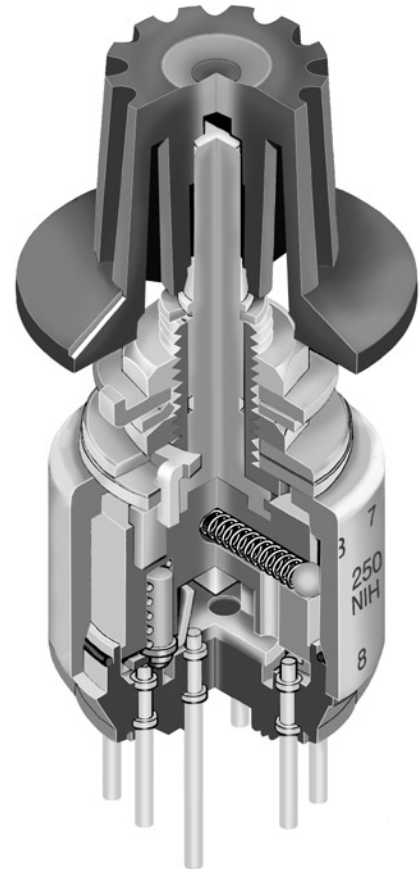

Actual Size

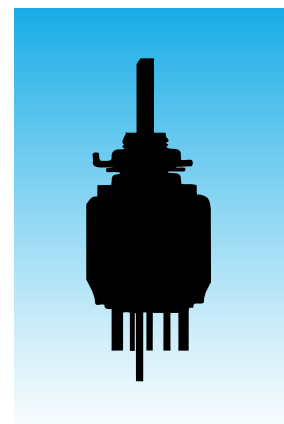

# General Specifications

## Electrical Capacity (Resistive Load)

**For MRA:** 250mA @ 125V AC  
**For MRF or MRK:** 0.4VA maximum @ 28V AC/DC maximum  
 (Applicable Range 0.1mA ~ 0.1A @ 20mV ~ 28V)  
 Note: Find additional explanation of operating range in Supplement section.

## Other Ratings

**Contact Resistance:** 10 milliohms maximum for MRA; 50 milliohms maximum for MRF & MRK  
**Insulation Resistance:** 100 megohms minimum @ 500V DC  
**Dielectric Strength:** 1,000V AC minimum for 1 minute minimum for MRA  
 500V AC minimum for 1 minute minimum for MRF & MRK  
**Mechanical Life:** 30,000 operations minimum  
**Electrical Life:** 10,000 operations minimum  
**Range of Operating Torque:** 0.02 ~ 0.07Nm for MRA; 0.005 ~ 0.02Nm for MRF & MRK  
**Contact Timing:** Nonshorting (break-before-make)  
 MRA – self-cleaning, sliding contact; MRF & MRK – self-cleaning, rotary contactor disk  
**Indexing:** 30°

## Materials & Finishes

**Shaft:** Brass with nickel plating  
**Stopper Plate:** Steel with zinc plating for MRA & MRK; polyamide cover with stopper for MRF  
**Bushing/Housing:** Zinc alloy with zinc plating  
**Movable Contacts:** Copper with silver plating for MRA; phosphor bronze with gold plating for MRF & MRK  
**End Contacts & Terminals:** Brass with silver plating for MRA; phosphor bronze with gold plating for MRF & MRK  
**Common Contacts & Terminals:** Brass with silver plating for MRA; phosphor bronze with gold plating for MRF & MRK  
**Base:** Diallyl phthalate for MRA; fiberglass reinforced polyamide for MRF & MRK

## Environmental Data

**Operating Temperature Range:** -10°C through +70°C (+14°F through +158°F)  
**Humidity:** 90 ~ 95% humidity for 96 hours @ 40°C (104°F)  
**Vibration:** 10 ~ 55Hz with peak-to-peak amplitude of 1.5mm traversing the frequency range & returning in 1 minute; 3 right angled directions for 2 hours  
**Shock:** 50G (490m/s<sup>2</sup>) acceleration (tested in 3 right angled directions, with 3 shocks in each direction)

## Installation

**Mounting Torque:** .686Nm (6.08 lb•in)  
**Cap Installation Force:** 19.6 ~ 29.4N (4.41 ~ 6.61 lbf) for MRA & MRK

## Processing

**Soldering Time & Temperature:** Wave Soldering for MRA: See Profile A in Supplement section.  
 Wave Soldering for MRF & MRK: See Profile B in Supplement section.  
 Manual Soldering for MRA: See Profile A in Supplement section.  
 Manual Soldering for MRF & MRK: See Profile B in Supplement section.  
**Cleaning:** Automated cleaning recommended. Stopper plate, as well as washers for MRA & MRK, must be in place to maintain automated cleaning. See Cleaning specifications in Supplement section.

## Standards & Certifications

**UL Recognition or CSA Certification:** MRA, MRF, & MRK models have not been tested for UL recognition or CSA certification. These switches are designed for use in a low-voltage, low-current, logic-level circuit. When used as intended in a logic-level circuit, the results do not produce hazardous energy.

### TYPICAL SWITCH ORDERING EXAMPLE

MR

A

206

A



| ACTUATORS & TERMINALS |  |
|-----------------------|--|
| <b>A</b>              | Shaft Actuated with PC Terminals                   |
| <b>F</b>              | Low Profile Screwdriver Actuated with PC Terminals |
| <b>K</b>              | Low Profile Shaft Actuated with PC Terminals       |

| POLES & CIRCUITS |                        |
|------------------|------------------------|
| <b>112</b>       | SP with 2-12 Positions |
| <b>206</b>       | DP with 2-6 Positions  |
| <b>403</b>       | 4P with 2-3 Positions  |

| KNOBS    |                    |
|----------|--------------------|
| <b>A</b> | Plain Black        |
| <b>B</b> | Small Color Tipped |
| <b>C</b> | Large Color Tipped |

| COLORS           |        |
|------------------|--------|
| For Plain Knob   |        |
| <b>No Code</b>   | Black  |
| For Color Tipped |        |
| <b>A</b>         | Black  |
| <b>B</b>         | White  |
| <b>C</b>         | Red    |
| <b>E</b>         | Yellow |
| <b>F</b>         | Green  |
| <b>G</b>         | Blue   |
| <b>H</b>         | Gray   |

### DESCRIPTION FOR TYPICAL ORDERING EXAMPLE

**MRA206-A**

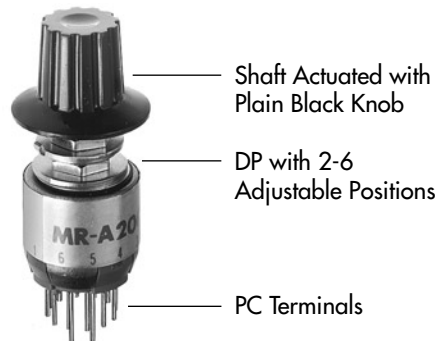

### ACTUATORS & TERMINALS

**A** Shaft Actuated with PC Terminals

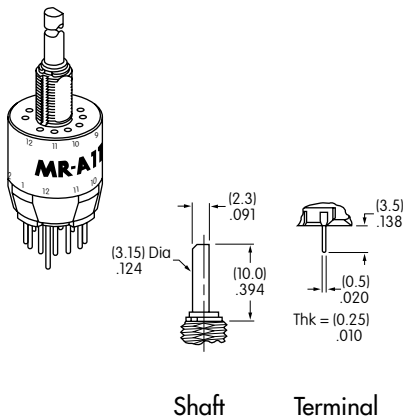

**F** Low Profile Screwdriver Actuated with PC Terminals

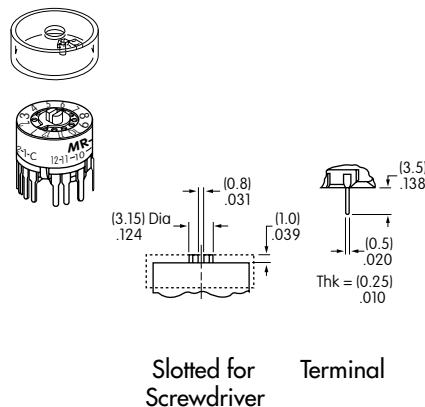

**K** Low Profile Shaft Actuated with PC Terminals

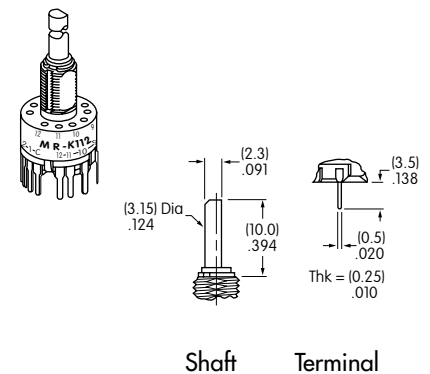

### POLES & CIRCUITS

| Pole | Model  | Number of Positions | Stopper Settings  | Number of Terminals | Schematics |
|------|--------|---------------------|-------------------|---------------------|------------|
| SP   | MRA112 | 2-12                | 2, 3, 4, . . . 12 | 1 COM, 12 LOAD      |            |
|      | MRF112 | 2-12                | 2, 3, 4, . . . 12 | 1 COM, 12 LOAD      |            |
|      | MRK112 | 2-12                | 2, 3, 4, . . . 12 | 1 COM, 12 LOAD      |            |
| DP   | MRA206 | 2-6                 | 2, 3, 4, 5, 6     | 2 COM, 12 LOAD      |            |
|      | MRF206 | 2-6                 | 2, 3, 4, 5, 6     | 2 COM, 12 LOAD      |            |
|      | MRK206 | 2-6                 | 2, 3, 4, 5, 6     | 2 COM, 12 LOAD      |            |
| 4P   | MRA403 | 2-3                 | 2, 3              | 4 COM, 12 LOAD      |            |
|      | MRF403 | 2-3                 | 2, 3              | 4 COM, 12 LOAD      |            |
|      | MRK403 | 2-3                 | 2, 3              | 4 COM, 12 LOAD      |            |

### POSITION SETTING FOR MRA, MRF, & MRK MODELS

Each switch is supplied with the stopper set for the maximum number of positions allowed for that model. Prior to installation, the desired position setting should be made. Contact factory for continuous rotation.

#### MRF Models

1. Remove the protective cover from the switch body.
2. Turn the shaft counterclockwise to the extreme left by using a screwdriver.
3. Inside the cover is a magnifying lens which would be positioned over the number which is to be the maximum position used; when the cover is then snapped into the switch, the projection beside the lens fits into the correct hole for setting the stop.

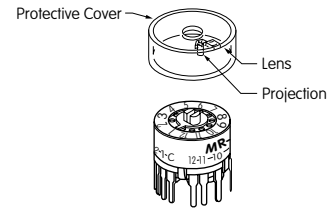

#### MRK & MRA Models

1. Using the actuator knob, turn the shaft counterclockwise to the extreme left. If the shaft is not turned counterclockwise to the extreme left, proper setting cannot be achieved. At this extreme position, the white line on the knob points to the number 1 position shown on the side of the switch.
2. Remove the knob from the shaft and loosen the nut far enough to allow raising the stopper plate, plus washer(s), for resetting to the desired position.
3. Note the position numbers on the side of the switch; these correspond to the terminal numbers and stopper holes. Insert the stopper in the hole numbered for the maximum desired number of stop settings. Satisfactory switch functioning cannot be assured if the stopper plate is not properly positioned.
4. Tighten the nut (beveled side up) firmly against the stopper plate.

#### Standard Mounting Hardware Packaged Loose with Each Switch:

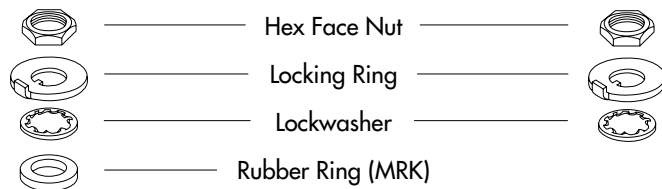

#### Factory Assembled:

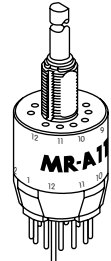
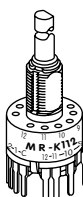
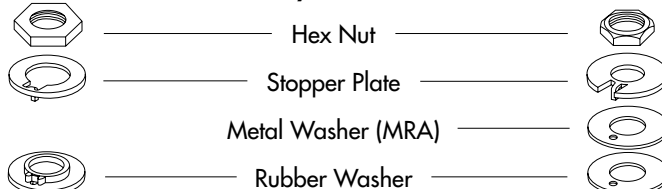

### TYPICAL SWITCH DIMENSIONS

#### MRA • PC Terminals



MRA112

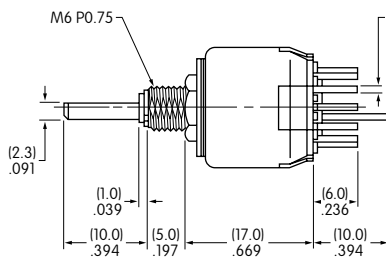
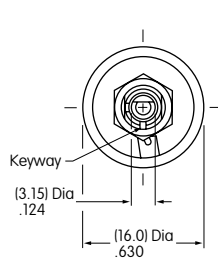

#### 1 Pole

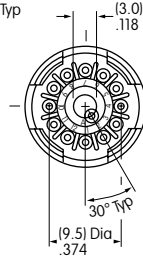

#### 2 Pole

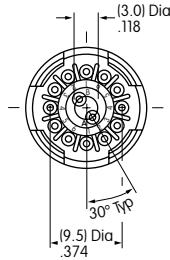

#### 4 Pole

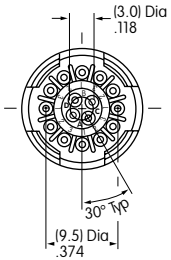

#### MRF • PC Terminals



MRF403

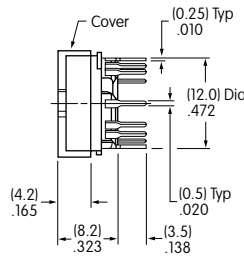
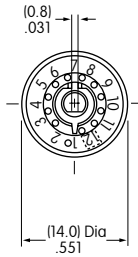

#### 1 Pole

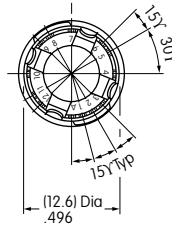

#### 2 Pole

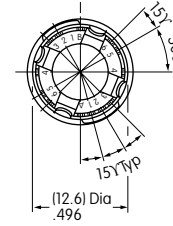

#### 4 Pole

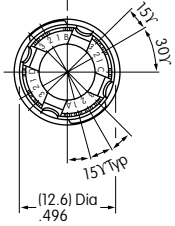

#### MRK • PC Terminals



MRK112

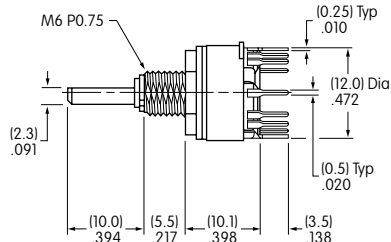
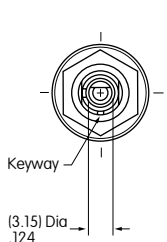

#### 1 Pole

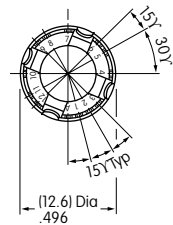

#### 2 Pole

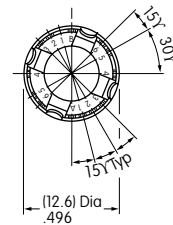

#### 4 Pole

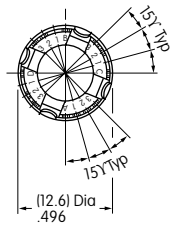

MRK devices are designed to be panel mounted. Installation without panel mounting will affect reliability.

### FOOTPRINTS

#### Single Pole MRA112

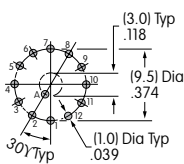

#### Double Pole MRA206

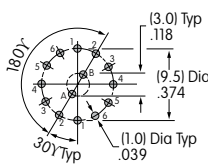

#### Four Pole MRA403

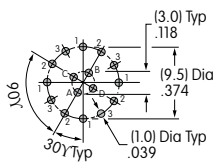

#### Single Pole MRF112 MRK112

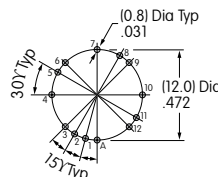

#### Double Pole MRF206 MRK206

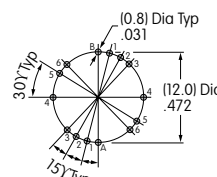

#### Four Pole MRF403 MRK403

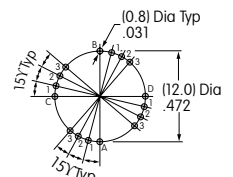

### KNOBS

#### A AT433 Plain Black

Material:  
Polyacetal

Color:  
Black  
only

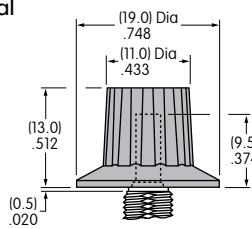

#### B AT4103 Small Color Tipped

Base Material:  
Polyester  
Base Color:  
Black

Polyamide Tip  
Colors:  
A, B, C, E, F, G, H

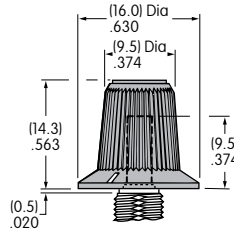

#### C AT4104 Large Color Tipped

Base Material:  
Polyester  
Base Color:  
Black

Polyamide Tip  
Colors:  
A, B, C, E, F, G, H

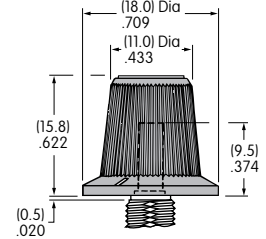

Color Codes: **A** Black **B** White **C** Red **E** Yellow **F** Green **G** Blue **H** Gray

### PANEL CUTOUTS & MAXIMUM EFFECTIVE PANEL THICKNESS

**Without Keyway**  
**Nonsealed Panel**

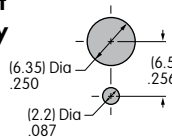

**With Keyway**  
**Nonsealed Panel**

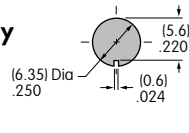

**Sealed Panel**

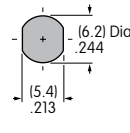

With Standard Hardware on Nonsealed Panel:  
MRA .067" (1.7mm) MRK .087" (2.2mm)

Without Locking Ring on Nonsealed Panel:  
MRA .098" (2.5mm) MRK .118" (3.0mm)

With Standard Hardware on Sealed Panel:  
MRK .106" (2.7mm)

### STANDARD MOUNTING HARDWARE

#### AT513M Metric Hexagon Nut

Material:  
Brass, nickel plating  
1 for MRA; 1 for MRK

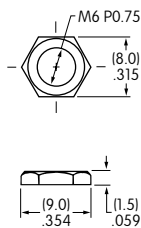

#### AT507M Metric Locking Ring

Material:  
Steel, chromate over zinc plating  
1 for MRA; 1 for MRK

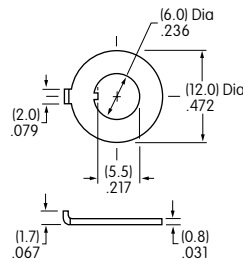

#### AT509 Lockwasher

Material:  
Steel, chromate over zinc plating  
1 for MRA; 1 for MRK

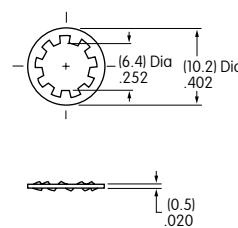

#### AT535 Rubber Ring

Material:  
Nitrile butadiene rubber  
1 for MRK

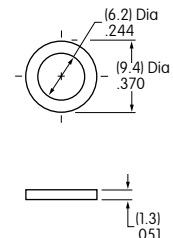

### OPTIONAL SUPPORT BRACKET

#### AT543 Support Bracket for MRK

Material:  
Steel with tin plating

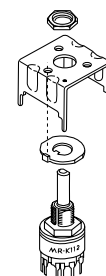
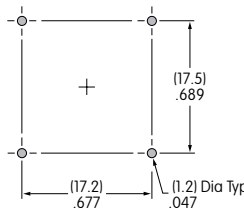
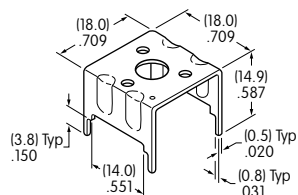

A support bracket is needed when the MRK is mounted only to a PC board and does not have the bushing through a panel.