

POWER MANAGEMENT

Features

- Dual input charger automatically selects adapter input over USB
- Constant voltage — 4.2V, 1% regulation
- Fast-charge current regulation — 15% at 70mA, 9% at 700mA
- Three mode charging (current regulation, voltage regulation, thermal limiting)
- Input voltage protection — 30V
- Current-limited adapter charging support — reduces power dissipation in charger
- USB input limits charge current to prevent Vbus overload
- Instantaneous CC-to-CV transition for faster charging
- Programmable battery-dependent currents (adapter-sourced fast-charge & pre-charge, termination)
- Programmable source-limited currents (USB-sourced fast-charge & pre-charge)
- Three termination options — float-charge, automatic re-charge, or forced re-charge to keep the battery topped-off after termination without float-charging
- Soft-start reduces adapter or USB load transients
- High operating voltage range permits use of unregulated adapters
- Complies with CCSA YD/T 1591-2006
- Space saving 2x2x0.6 (mm) MLPD package
- WEEE and RoHS compliant

Applications

- Mobile phones
- MP3 players
- GPS handheld receivers

Description

The SC820 is a dual input (adapter/USB) linear single-cell Li-ion battery charger in an 8 lead 2x2 MLPD ultra-thin package. Both inputs will survive sustained input voltage up to 30V to protect against hot plug overshoot and faulty charging adapters.

Charging begins automatically when a valid input source is applied to either input. The adapter input is selected when both input sources are present.

Thermal limiting protects the SC820 from excessive power dissipation when charging from either source. The SC820 can be programmed to turn off when charging is complete or to continue operating as an LDO regulator while float-charging the battery.

The adapter input charges with an adapter operating in voltage regulation or in current limit to obtain the lowest possible power dissipation by pulling the VAD input voltage down to the battery voltage. The VUSB input automatically limits load current to prevent over-loading the USB Vbus supply.

Charge current programming requires two resistors. One determines battery-capacity dependent currents: adapter input fast-charge current, pre-charge current, and charge termination current. The other independently determines input-limited USB charging currents: USB input fast-charge and pre-charge current.

Typical Application Circuit

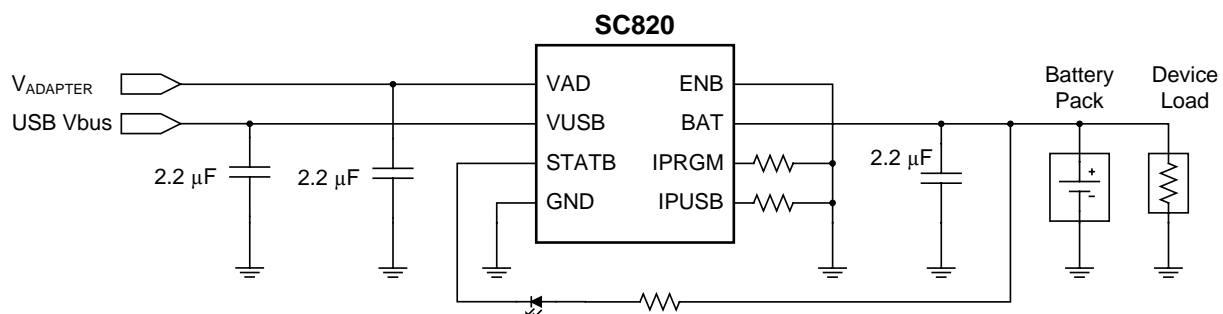

Pin Configuration

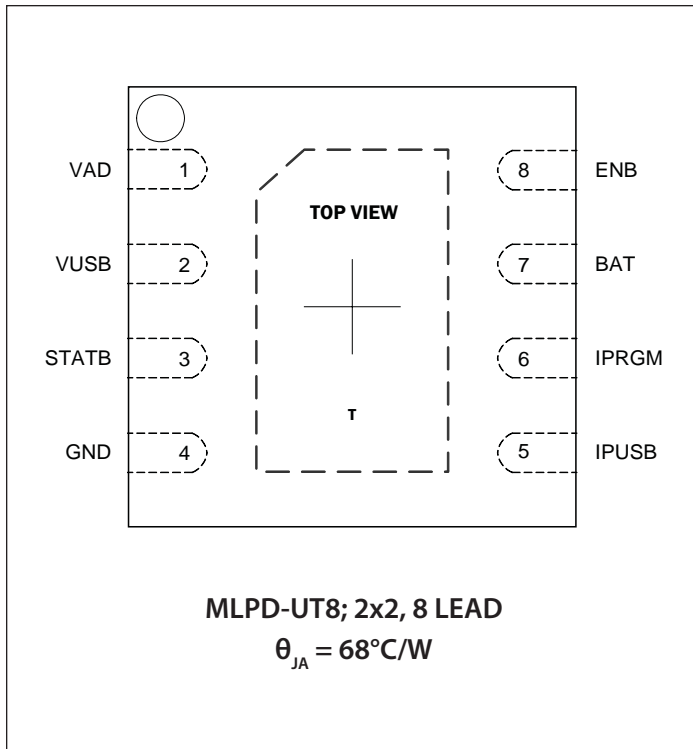

Ordering Information

Device	Package
SC820ULTRT ⁽¹⁾⁽²⁾	MLPD-UT-8 2x2
SC820EVB	Evaluation Board

Notes:

- (1) Available in tape and reel only. A reel contains 3,000 devices.
- (2) Lead-free package only. Device is WEEE and RoHS compliant.

Marking Information

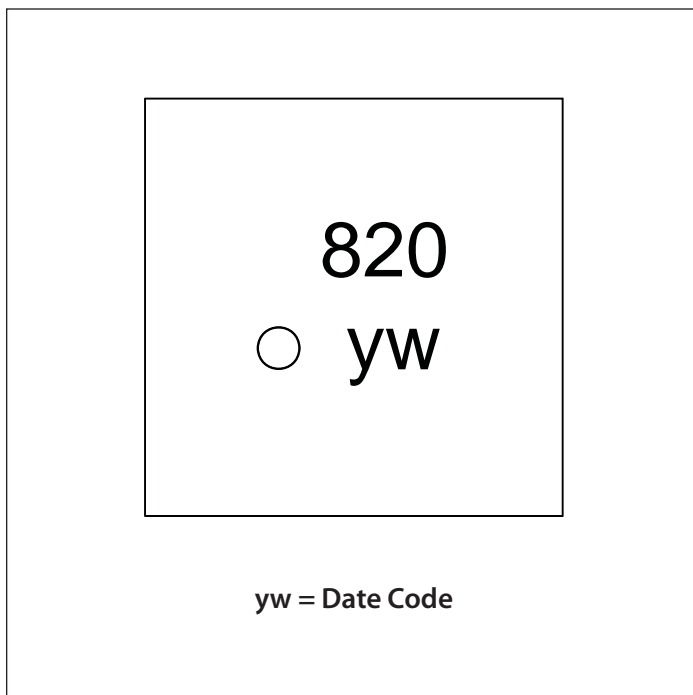

Absolute Maximum Ratings

VAD and VUSB (V)	-0.3 to +30.0
BAT, IPRGM, IPUSB (V)	-0.3 to +6.5
STATB, EN (V)	-0.3 to $V_{BAT} + 0.3$
VAD Input Current (A)	1.5
VUSB Input Current (A)	1.5
BAT, IPRGM, IPUSB Short-to-GND Duration	Continuous
Total Power Dissipation (W)	2
ESD Protection Level ⁽¹⁾ (kV)	2

Recommended Operating Conditions

Operating Ambient Temperature (°C) -40 to +85

Thermal Information

Thermal Resistance, Junction to Ambient⁽²⁾ (°C/W) 68
 Junction Temperature Range (°C) +150
 Storage Temperature Range (°C) -65 to +150
 Peak IR Reflow Temperature (10s to 30s) (°C) +260

Exceeding the above specifications may result in permanent damage to the device or device malfunction. Operation outside of the parameters specified in the Electrical Characteristics section is not recommended.

NOTES:

(1) Tested according to JEDEC standard JESD22-A114-B.

(2) Calculated from package in still air, mounted to 3 x 4.5 (in), 4 layer FR4 PCB with thermal vias under the exposed pad per JESD51 standards.

Electrical Characteristics

Test Conditions: $V_{VAD} = V_{VUSB} = 4.75V$ to $5.25V$; $V_{BAT} = 3.7V$; Typ values at 25°C; Min and Max at $-40^{\circ}C < T_A < 85^{\circ}C$, unless specified.

Parameter	Symbol	Conditions	Min	Typ	Max	Units
VAD Operating Voltage ⁽¹⁾	V_{AD-OP}		4.60	5.00	8.20	V
VAD Select Rising Threshold	$VT_{ADsel-R}$		4.30	4.45	4.60	V
VAD Deselect Falling Threshold ⁽²⁾	$VT_{ADsel-F}$	$V_{VAD} > V_{BAT}$	2.70	2.85	3.00	V
USB Input Operating Voltage ⁽¹⁾	V_{USB-OP}		4.35	5.00	8.20	V
VUSB Select Rising Threshold	$VT_{USBsel-R}$	$V_{VUSB} > V_{BAT}$		4.20	4.35	V
VUSB Deselect Falling Threshold	$VT_{USBsel-F}$	$V_{VUSB} > V_{BAT}$	3.65	4.00		V
VUSB Select Hysteresis	$VT_{USBsel-H}$	$VT_{USBsel-R} - VT_{USBsel-F}$	100			mV
OVP Rising Threshold	VT_{OVP-R}	VAD or VUSB input			9.6	V
OVP Falling Threshold	VT_{OVP-F}	VAD or VUSB input	8.2			V
OVP Hysteresis	VT_{OVP-H}	$(VT_{OVP-R} - VT_{OVP-F})$	50			mV
VAD Charging Disabled Quiescent Current	Iq_{VAD_DIS}	$V_{VUSB} = 0V, V_{ENB} = V_{BAT}$		2	3	mA
VAD Charging Enabled Quiescent Current	Iq_{VAD_EN}	$V_{VUSB} = 0V, V_{ENB} = 0V,$ excluding I_{BAT}, I_{IPRGM} and I_{IPUSB}		2	3	mA
VUSB Charging Disabled Quiescent Current	Iq_{VUSB_DIS}	$V_{VAD} = 0V; V_{ENB} = V_{BAT}$		2	3	mA
VUSB Charging Enabled Quiescent Current	Iq_{VUSB_EN}	$V_{VAD} = 0V, V_{ENB} = 0V,$ excluding I_{BAT}, I_{IPRGM} and I_{IPUSB}		2	3	mA

Electrical Characteristics (continued)

Parameter	Symbol	Conditions	Min	Typ	Max	Units
VUSB Deselected Quiescent Current ⁽³⁾	$I_{Q_{VUSB_DES}}$	$V_{VAD} \geq V_{VUSB}$		25	50	μA
CV Regulation Voltage	V_{CV}	$I_{BAT} = 50\text{mA}$, $-40^\circ\text{C} \leq T_J \leq 125^\circ\text{C}$	4.16	4.20	4.24	V
CV Voltage Load Regulation ⁽⁴⁾	V_{CV_LOAD}	Relative to V_{CV} @ 50mA, $V_{VAD} = 5\text{V}$, or $V_{VUSB} = 5\text{V}$ and $V_{VAD} = 0\text{V}$, $1\text{mA} \leq I_{BAT} \leq 700\text{mA}$, $-40^\circ\text{C} \leq T_J \leq 125^\circ\text{C}$	-20		10	mV
Re-charge Threshold	$V_{T_{ReQ}}$	$V_{CV} - V_{BAT}$	60	100	140	mV
Pre-charge Threshold (rising)	$V_{T_{PreQ}}$		2.85	2.90	2.95	V
Battery Leakage Current	I_{BAT_V0}	$V_{BAT} = V_{CV}$, $V_{VAD} = V_{VUSB} = 0\text{V}$		0.1	1	μA
	I_{BAT_DIS}	$V_{BAT} = V_{CV}$, $V_{VAD} = V_{VUSB} = 5\text{V}$, $V_{ENB} = 2\text{V}$		0.1	1	μA
	I_{BAT_MON}	$V_{BAT} = V_{CV}$, $V_{VAD} = V_{VUSB} = 5\text{V}$, ENB not connected		0.1	1	μA
IPRGM Programming Resistor	R_{IPRGM}		2.05		29.4	k Ω
Fast-Charge Current, VAD input	I_{FQ_AD}	$R_{IPRGM} = 2.94\text{k}\Omega$, $V_{T_{PreQ}} < V_{BAT} < V_{CV}$	643	694	745	mA
Pre-Charge Current, VAD input	I_{PreQ_AD}	$R_{IPRGM} = 2.94\text{k}\Omega$, $1.8\text{V} < V_{BAT} < V_{T_{PreQ}}$	105	139	173	mA
Termination Current, either input	I_{TERM}	$R_{IPRGM} = 2.94\text{k}\Omega$, $V_{BAT} = V_{CV}$	59	69	80	mA
VAD to BAT Dropout Voltage	V_{DO_AD}	$I_{BAT} = 700\text{mA}$, $0^\circ\text{C} \leq T_J \leq 125^\circ\text{C}$		0.75	1.0	V
IUSB Programming Resistor	R_{IUSB}		2.05		29.4	k Ω
Fast-Charge Current, VUSB input	I_{FQ_USB}	$R_{IUSB} = 4.42\text{k}\Omega$, $V_{T_{PreQ}} < V_{BAT} < V_{CV}$	427	462	497	mA
Pre-Charge Current, VUSB input	I_{PreQ_USB}	$R_{IUSB} = 4.42\text{k}\Omega$, $1.8\text{V} < V_{BAT} < V_{T_{PreQ}}$	69	92	116	mA
VUSB to BAT Dropout Voltage	V_{DO_USB}	$I_{BAT} = 500\text{mA}$, $0^\circ\text{C} \leq T_J \leq 125^\circ\text{C}$		0.55	1	V
IPRGM Fast-charge Regulated Voltage	V_{IPRGM_FQ}	$V_{VAD} = 5.0\text{V}$, $V_{VUSB} = 0\text{V}$, $V_{T_{PreQ}} < V_{BAT} < V_{CV}$		2.04		V
IPRGM Pre-charge Regulated Voltage	V_{IPRGM_PQ}	$V_{BAT} < V_{T_{PreQ}}$		0.408		V
IPRGM Termination Threshold Voltage	$V_{T_{IPRGM_TERM}}$	$V_{BAT} = V_{CV}$ (either input selected)		0.204		V
IUSB Fast-charge Regulated Voltage	V_{IUSB_FQ}	$V_{VAD} = 0\text{V}$, $V_{T_{PreQ}} < V_{BAT} < V_{CV}$		2.04		V
IUSB Pre-charge Regulated Voltage	V_{IUSB_PQ}	$V_{VAD} = 0\text{V}$, $V_{BAT} < V_{T_{PreQ}}$		0.408		V
VUSB Under-Voltage Load Regulation Limiting Voltage	$V_{VUSB_UV_LIM}$	$5\text{mA} \leq \text{VUSB supply current limit} \leq 500\text{mA}$, $V_{VAD} = 0\text{V}$, $R_{IUSB} = 3.65\text{k}\Omega$ (559mA)	4.45	4.58	4.70	V

Electrical Characteristics (continued)

Parameter	Symbol	Conditions	Min	Typ	Max	Units
Thermal Limiting Threshold Temperature	T_{TL}			130		°C
Thermal Limiting Rate	i_T			50		mA/°C
ENB Input High Voltage	V_{IH}		1.6			V
ENB Input Mid Voltage	V_{IM}		0.7		1.3	V
ENB Input Low Voltage	V_{IL}				0.3	V
ENB Input High-range Threshold Input Current	I_{IH_TH}	ENB current required to pull ENB from floating midrange into high range		23	50	μA
ENB Input High-range Sustain Input Current	I_{IH_SUS}	Current required to hold ENB in high range, $\text{Min } V_{IH} \leq V_{ENB} \leq V_{BAT}$ $\text{Min } V_{IH} \leq V_{BAT} \leq 4.2V$		0.3	1	μA
ENB Input Mid-range Load Limit	I_{IM}	Input will float to mid range when this load limit is observed.	-5		5	μA
ENB Input Low-range Input Current	I_{IL}	$0V \leq V_{ENB} \leq \text{Max } V_{IL}$	-25	-12		μA
ENB Input Leakage	I_{ILEAK}	$V_{VIN} = 0V, V_{ENB} = V_{BAT} = 4.2V$			1	μA
STATB Output Low Voltage	V_{STAT_LO}	$I_{STAT_SINK} = 2mA$			0.5	V
STATB Output High Current	I_{STAT_HI}	$V_{STAT} = 5V$			1	μA

Notes:

- (1) Maximum operating voltage is the maximum V_{supply} as defined in EIA/JEDEC Standard No. 78, paragraph 2.11. This is the input voltage at which the charger is guaranteed to begin operation.
- (2) Sustained operation to $V_{T_{ADsel-F}} \leq V_{VAD}$ is guaranteed only if a current limited charging source applied to VAD is pulled below $V_{T_{ADsel-R}}$ by the charging load; forced VAD voltage below $V_{T_{ADsel-R}}$ may in some cases result in regulation errors or other unexpected behavior.
- (3) If VAD is the selected input but $V_{VAD} < V_{VUSB}$, such as when VAD is operating with an adapter in current limit while a VUSB charging source is applied, $I_{q_{VUSB_DES}}$ will increase to approximately $I_{q_{VUSB_EN}}$.
- (4) At load currents exceeding 700mA, or at 700mA while at elevated ambient temperature, the charger may enter dropout with a 5V input before the battery voltage has risen to V_{CV} . See the specification of V_{DO_AD} . Although this is a safe and acceptable mode of operation, specification of V_{CV} when in dropout is not applicable; higher input voltage will restore the charger to CV regulation in these cases. Note that V_{BAT} is always less than V_{CV} while in dropout. As the battery state-of-charge increases, the charging current will decrease allowing the battery voltage to rise to V_{CV} and CV regulation will begin. This appears as a softening or rounding of the CC-to-CV regulation mode transition, similar to that seen in chargers with a linear CC-to-CV regulation crossover.

Typical Characteristics

CV Line Regulation

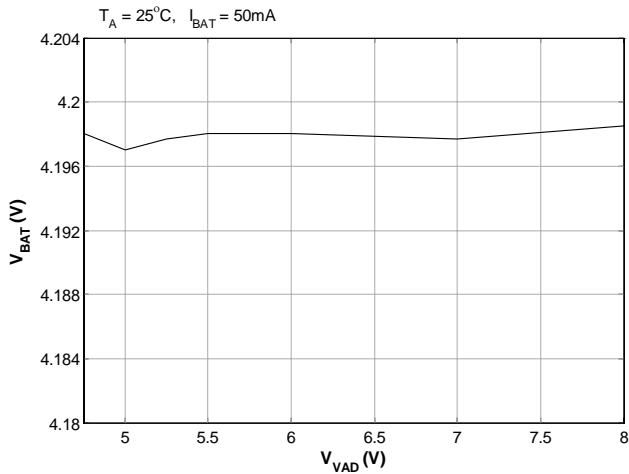

CV Load Regulation

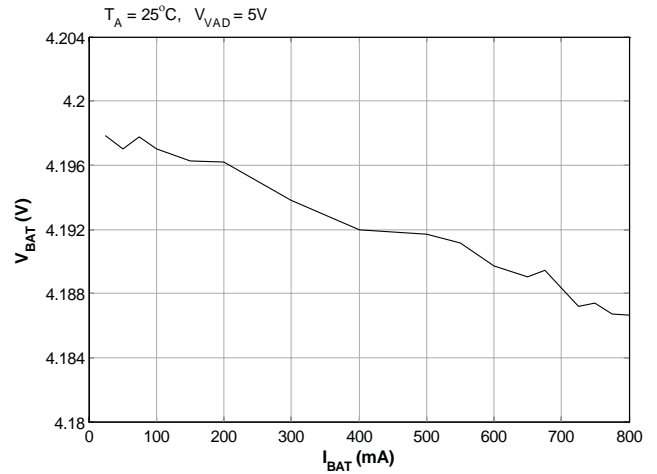

CV Temperature Regulation

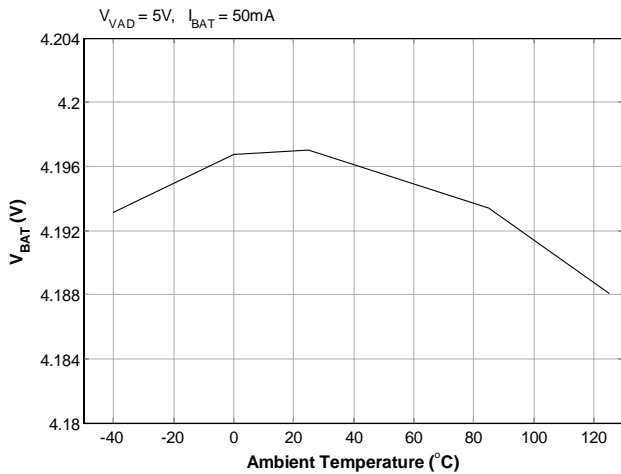

CC FQ Line Regulation (AD or USB)

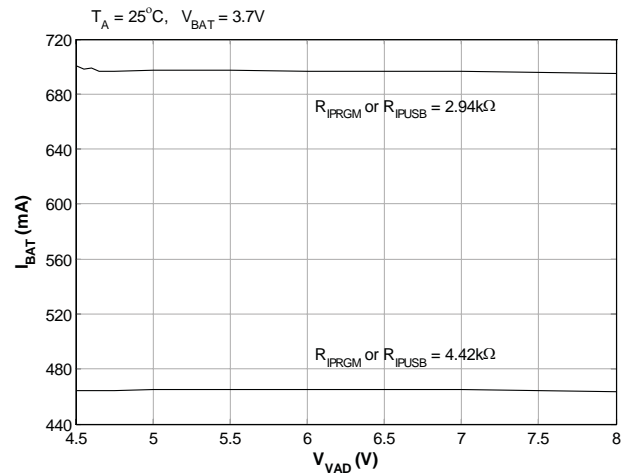

CC FQ V_{BAT} Regulation (AD or USB)

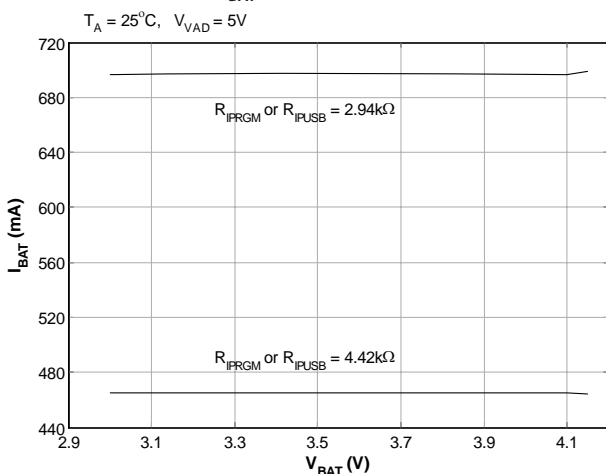

CC FQ Temperature Regulation (AD or USB)

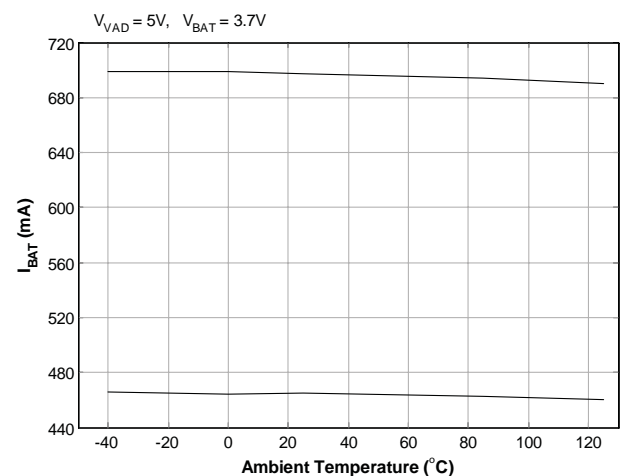

Typical Characteristics (continued)

CC PQ Line Regulation (AD or USB)

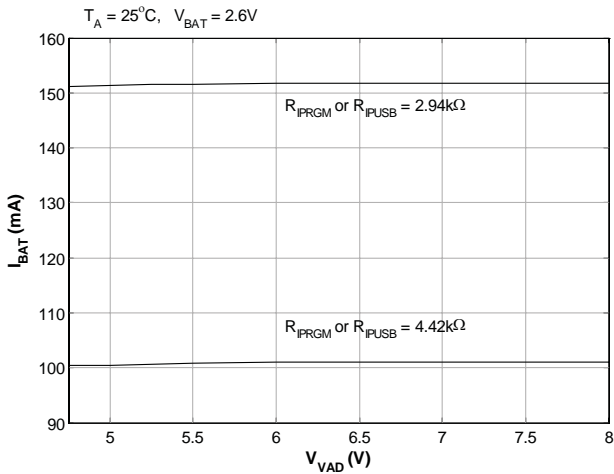

CC PQ Temperature Regulation (AD or USB)

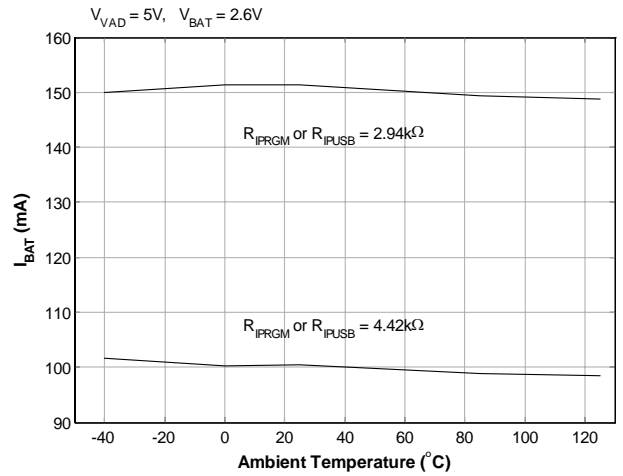

I_{FQ_AD} vs. R_{IPRGM} , or I_{FQ_USB} vs. R_{IPUSB}

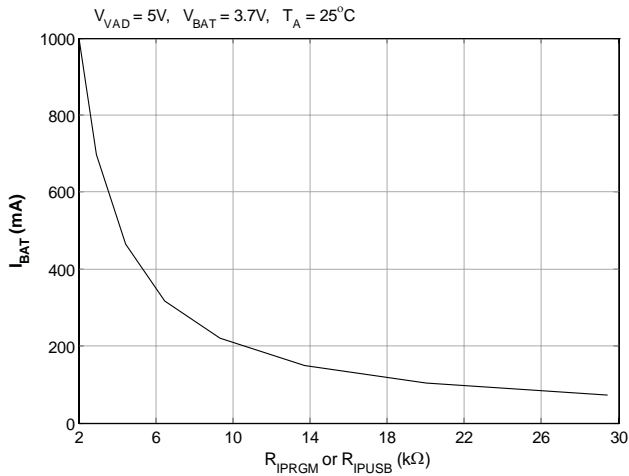

I_{PQ_AD} vs. R_{IPRGM} , or I_{PQ_USB} vs. R_{IPUSB}

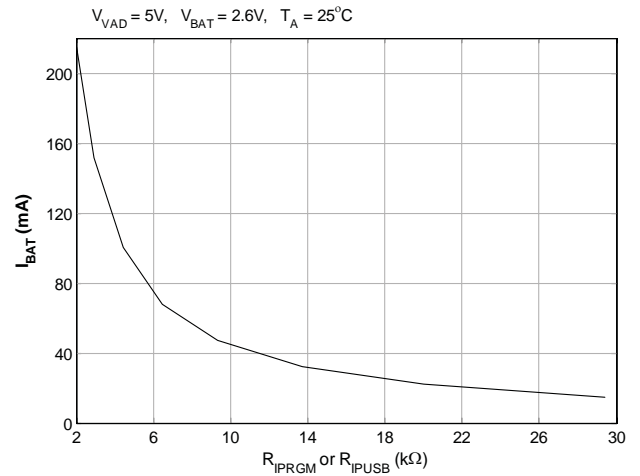

CC — Input Reselection, AD to USB

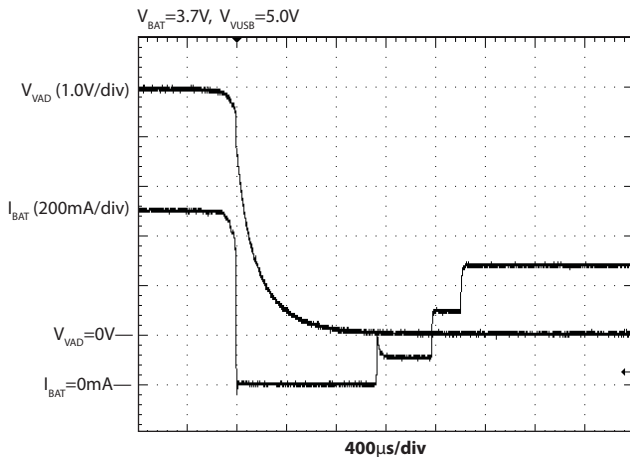

CC — Input Reselection, USB to AD

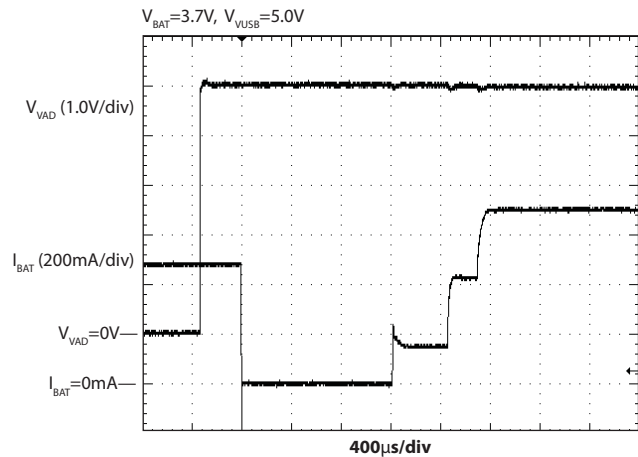

Typical Characteristics (continued)

Charging Cycle Battery Voltage and Current

850mAh battery, $R_{IPRGM} = 2.94k\Omega$, $V_{VAD} = 5.0V$, $T_A = 25^\circ C$

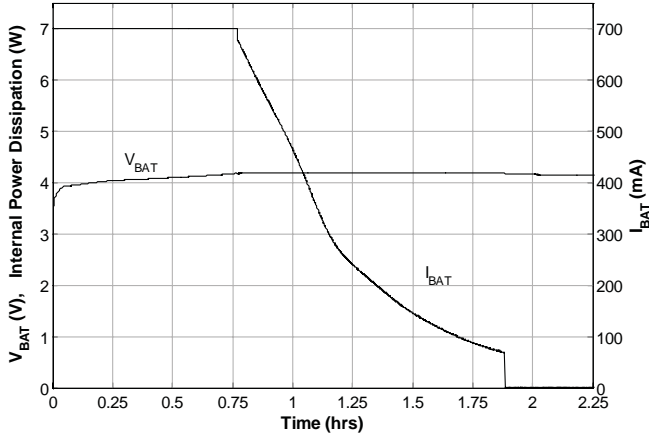

Pre-Charging Battery Voltage and Current

850mAh battery, $R_{IPRGM} = 2.94k\Omega$, $V_{VAD} = 5.0V$, $T_A = 25^\circ C$

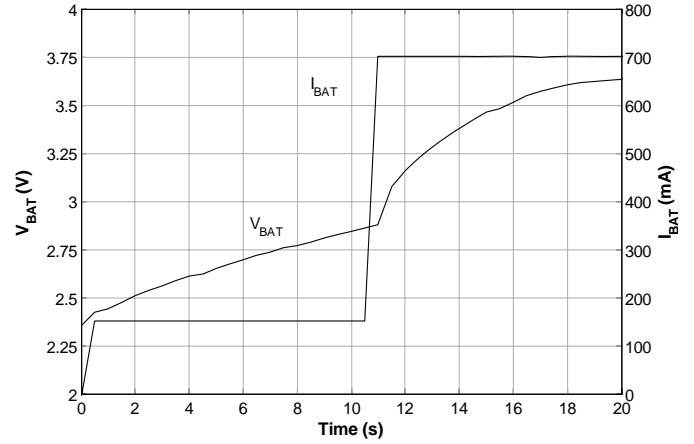

CC-to-CV Battery Voltage and Current

850mAh battery, $R_{IPRGM} = 2.94k\Omega$, $V_{VAD} = 5.0V$, $T_A = 25^\circ C$

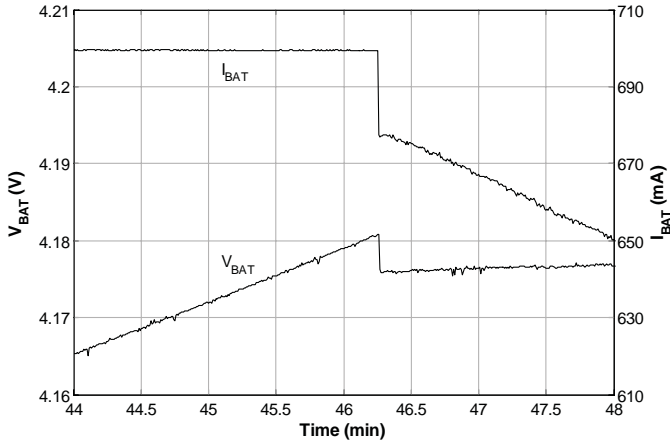

Re-Charge Cycle Battery Voltage and Current

850mAh battery, $R_{IPRGM} = 2.94k\Omega$, $V_{VAD} = 5.0V$, Load = 10mA

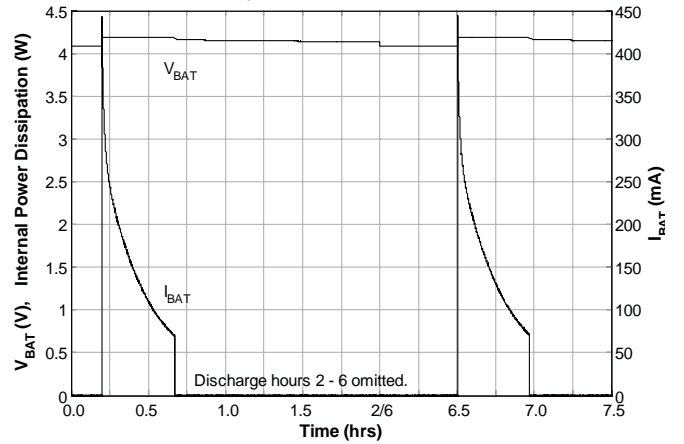

Pin Descriptions

Pin #	Pin Name	Pin Function
1	VAD	Supply pin — connect to charging adapter. This pin is protected against damage due to high voltage up to 30V.
2	VUSB	Supply pin — connect to USB Vbus power. Typically 5V, limited load-current input. This pin is protected against damage due to high voltage up to 30V.
3	STATB	Status output pin — This open-drain pin is asserted (pulled low) when a valid charging supply is connected to either VAD or VUSB, and a charging cycle begins. It is released when the termination current is reached, indicating that charging is complete. STATB is not asserted for re-charge cycles.
4	GND	Ground
5	IPUSB	Fast-charge and pre-charge current programming pin for the VUSB power source — VUSB fast-charge current is programmed by connecting a resistor from this pin to ground. VUSB pre-charge current is 20% of fast-charge current.
6	IPRGM	Fast-charge and pre-charge current programming pin for the adapter power source — VAD fast-charge current is programmed by connecting a resistor from this pin to ground. VAD pre-charge current is 20% of fast-charge current. The charging termination current threshold (for either VAD or VUSB input selection) is 10% of the IPRGM programmed fast-charge current.
7	BAT	Charger output — connect to battery positive terminal.
8	ENB	Combined device enable/disable — Logic high disables the device. Tie to GND to enable charging with indefinite float-charging. Float this pin to enable charging without float-charge upon termination. Note that this pin must be grounded if the SC820 is to be operated without a battery connected to BAT.
T	Thermal Pad	Pad is for heatsinking purposes — not connected internally. Connect exposed pad to ground plane using multiple vias.

Block Diagram

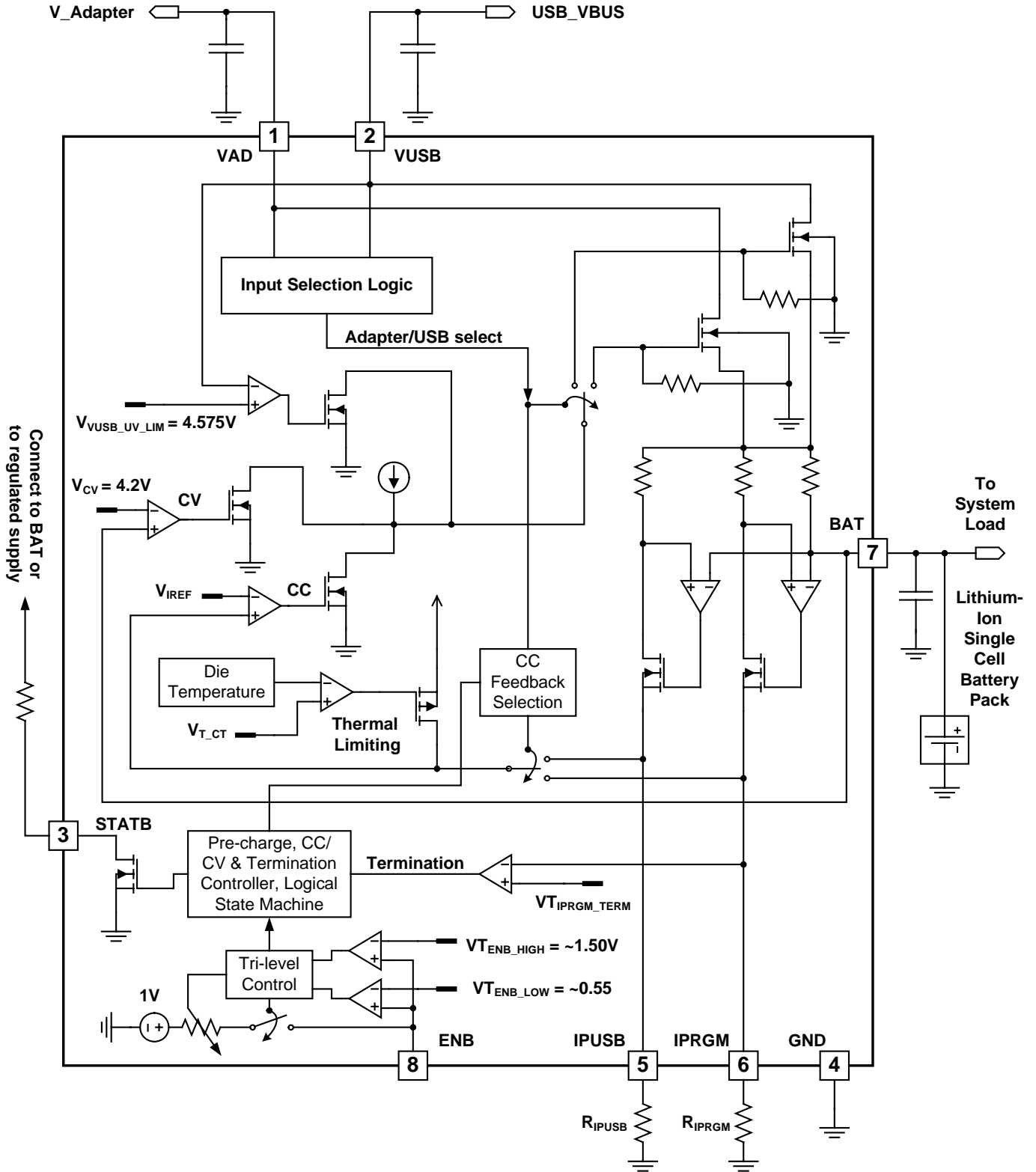

Applications Information

Charger Operation

The SC820 is a dual-input stand-alone Li-ion battery charger. The VAD input pin is optimized for a charging adapter. The VUSB pin is optimized for charging from the USB Vbus supply. The device is independently programmed for battery-capacity-dependent currents (adapter fast-charge current and termination current) using the IPRGM pin. Charging currents from the USB Vbus supply, which has a maximum load specification, are programmed using the IPUSB pin.

When an input supply is first detected, a charge cycle is initiated and the STATB open-drain output goes low. If the battery voltage is less than the pre-charge threshold voltage, the pre-charge current is supplied. Pre-charge current is 20% of the programmed fast-charge current for the selected input.

When the battery voltage exceeds the pre-charge threshold, typically within seconds for a standard battery with a starting cell voltage greater than 2V, the fast-charge Constant Current (CC) mode begins. The charge current soft-starts in three steps (20%, 60%, and 100% of programmed fast-charge current) to reduce adapter load transients. CC current is programmed by the IPRGM resistance to ground when the VAD input is selected and by the IPUSB resistance to ground when the VUSB input is selected.

The charger begins Constant Voltage (CV) regulation when the battery voltage rises to the fully-charged single-cell Li-ion regulation voltage (V_{CV}), nominally 4.2V. In CV regulation, the output voltage is regulated, and as the battery charges, the charge current gradually decreases. The STATB output goes high when I_{BAT} drops below the termination current threshold, which is 10% of the IPRGM pin programmed fast-charge current regardless of the input selected. This is known as charge termination.

Optional Float-charging or Monitoring

Depending on the state of the ENB input, upon termination the SC820 either operates indefinitely as a voltage regulator (float-charging) or it turns off its output. If the output is turned off upon termination, the device enters the monitor state. In this state, the output remains off until the BAT pin voltage decreases by the re-charge threshold ($V_{T_{ReQ}}$). A re-charge cycle then begins auto-

matically and the process repeats. A forced re-charge cycle can also be periodically commanded by the processor to keep the battery topped-off without float-charging. See the Monitor State section for details. Re-charge cycles are not indicated by the STATB pin.

Charging Input Selection

The SC820 has two charging supply input pins. VAD is optimized for adapter charging. VUSB is optimized for charging from the USB Vbus power supply. The inputs differ in selection rising and deselection falling thresholds, their behavior when overloading their respective charging sources, and in which current programming pin determines the fast-charge and pre-charge current. Both use the same Over-Voltage Protection (OVP) threshold.

Glitch filtering is performed on the VAD and VUSB inputs, so an applied input voltage that is ringing across its selection threshold will not be selected until the ringing has ceased. When both inputs exceed their respective UVLO thresholds, VAD is selected even when VAD voltage is applied while already charging from the VUSB input. VAD is also selected in the case that the VAD voltage exceeds its OVP threshold, so that an excessive VAD voltage will disable charging despite the presence of a valid VUSB input voltage.

When a valid input (defined as greater than its selection threshold and less than the OVP threshold) is first selected, a charge cycle is initiated and the STATB output is asserted. When a new input selection is made (when VAD is applied or removed while VUSB is present), the charge cycle is immediately halted and re-initiated with the newly selected input. There is a momentary (approximately 1ms) interruption in output current and a release and re-assertion of the STATB pin during input reselection.

If the VAD input charging current loads the adapter beyond its current limit, the VAD input voltage will be pulled down to just above the battery voltage. The adapter input deselection falling threshold is set close to the battery voltage pre-charge threshold to permit low-dissipation charging from a current limited adapter.

The VUSB input provides a higher deselection falling threshold appropriate to the USB specification. The USB

Applications Information (continued)

input also provides Under-Voltage Load Regulation (UVLR), in which the charging current is reduced if needed to prevent overloading of the USB Vbus supply. UVLR can serve as a low-cost alternative to directly programming the USB low power charge current. It is also useful where there is no signal available to indicate whether USB low or high power mode should be selected.

Constant Current Mode Fast-charge Current Programming

The Constant Current (CC) mode is active when the battery voltage is above the pre-charge threshold voltage ($V_{T_{PreQ}}$) and less than V_{CV} . When VAD is the selected input, the programmed CC regulation fast-charge (FQ) current is inversely proportional to the IPRGM pin resistance to GND according to the equation

$$I_{FQ_AD} = \frac{V_{IPRGM_Typ}}{R_{IPRGM}} \times 1000$$

When VUSB is the selected input, the programmed CC mode fast-charge current is inversely proportional to the IPUSB pin resistance to GND according to the equation

$$I_{FQ_USB} = \frac{V_{IPUSB_Typ}}{R_{IPUSB}} \times 1000$$

The fast-charge current can be programmed for a minimum of 70mA and a maximum of 995mA for either

input, nominally. The VAD input is designed for lower dropout voltage at high current, which ensures charging without thermal limiting with a charging adapter operating in current limit of at least 700mA.

Current regulation accuracy is dominated by gain error at high current settings and offset error at low current settings. The range of expected fast-charge output current versus programming resistance R_{IPRGM} or R_{IPUSB} (for VAD or VUSB input selected, respectively) is shown in Figures 1a and 1b. The figures show the nominal current versus nominal R_{IPRGM} or R_{IPUSB} resistance as the center plot and two theoretical limit plots indicating maximum and minimum current versus nominal programming resistance. These plots are derived from models of the expected worst-case contribution of error sources depending on programmed current. The current range includes the uncertainty due to 1% tolerance resistors. The dots on each plot indicate the currents obtained with standard value 1% tolerance resistors. Figures 1a and 1b show low and high resistance ranges, respectively.

Pre-charge Mode

This mode is automatically enabled when the battery voltage is below the pre-charge threshold voltage ($V_{T_{PreQ}}$). Pre-charge current conditions the battery for fast charging. The pre-charge current value is fixed at 20% nominally of the fast-charge current for the selected input. The fast-charge current is programmed by the

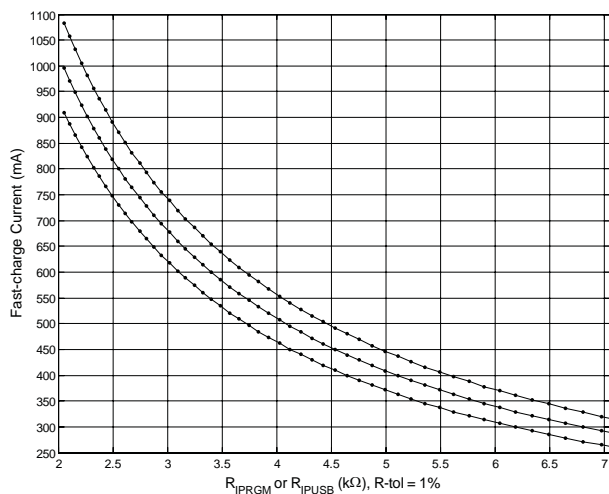

Figure 1a — Fast-charge Current Tolerance versus Programming Resistance, Low Resistance Range

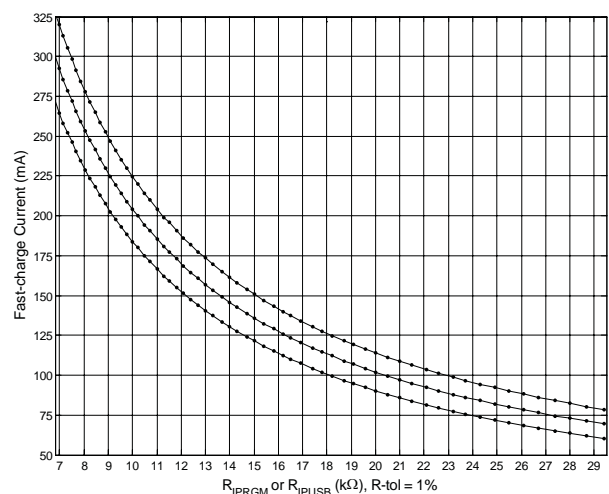

Figure 1b — Fast-charge Current Tolerance versus Programming Resistance, High Resistance Range

Applications Information (continued)

resistance between IPRGM and GND for the VAD input, and by the resistance between IPUSB and GND for the VUSB input.

Pre-charge current regulation accuracy is dominated by offset error. The range of expected pre-charge output current versus programming resistance is shown in Figures 2a and 2b. The figures show the nominal pre-charge current versus nominal resistance as the center plot and two theoretical limit plots indicating maximum and minimum current versus nominal programming resistance. These plots are derived from models of the expected worst-case contribution of error sources depending on programmed current. The current range includes the uncertainty due to 1% tolerance resistors. The dots on each plot indicate the currents obtained with standard value 1% tolerance resistors. Figures 2a and 2b show low and high resistance ranges, respectively.

Termination

When the battery voltage reaches V_{CV} , the SC820 transitions from constant current regulation to constant voltage regulation. While V_{BAT} is regulated to V_{CV} , the current into the battery decreases as the battery becomes fully charged. When the output current drops below the termination current threshold, charging terminates. Upon termination, the STATB pin open drain output turns off and the charger either enters monitor state or float-charges the battery, depending on the logical state of the ENB input pin.

The termination current threshold is fixed at 10% of the VAD input fast-charge current, as programmed by the resistance between IPRGM and GND. The IPRGM pin resistance determines the termination current threshold regardless of whether the selected charging input is VAD or VUSB.

Charger output current is the sum of the battery charge current and the system load current. Battery charge current changes gradually, and establishes a slowly diminishing lower bound on the output current while charging in CV mode. The load current into a typical digital system is highly transient in nature. Charge cycle termination is detected when the sum of the battery charging current and the greatest load current occurring within the immediate 300 μ s to 550 μ s past interval is less than the programmed termination current. This timing behavior permits charge cycle termination to occur during a brief low-load-current interval, and does not require that the longer interval average load current be small.

Termination current threshold accuracy is dominated by offset error. The range of expected termination current versus programming resistance R_{IPRGM} (for either VAD or VUSB input selected) is shown in Figures 3a and 3b. The figures show the nominal termination current versus nominal R_{IPRGM} resistance as the center plot and two theoretical limit plots indicating maximum and minimum current versus nominal programming resistance. These

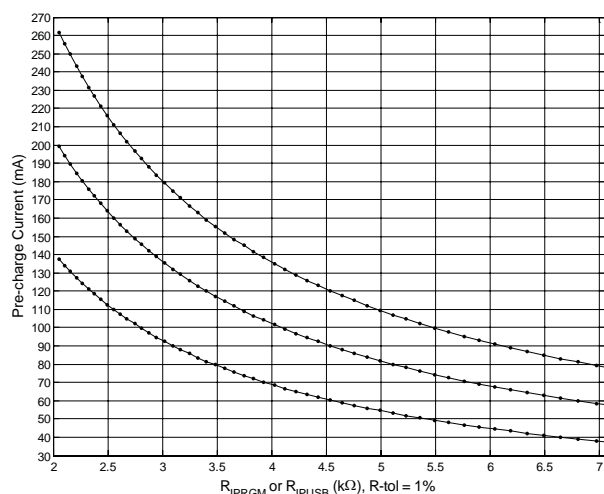

Figure 2a — Pre-charge Current Tolerance versus Programming Resistance, Low Resistance Range

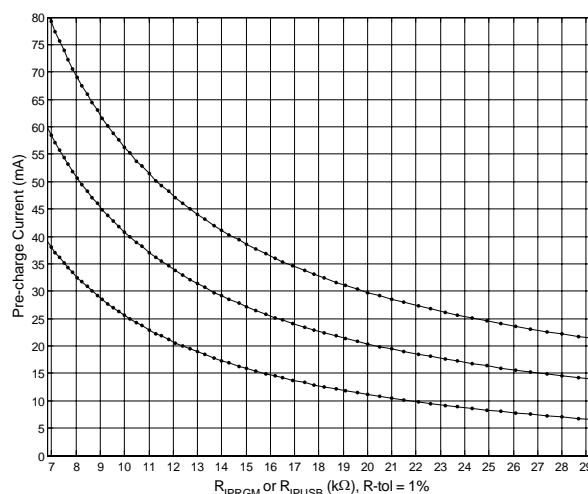

Figure 2b — Pre-charge Current Tolerance versus Programming Resistance, High Resistance Range

Applications Information (continued)

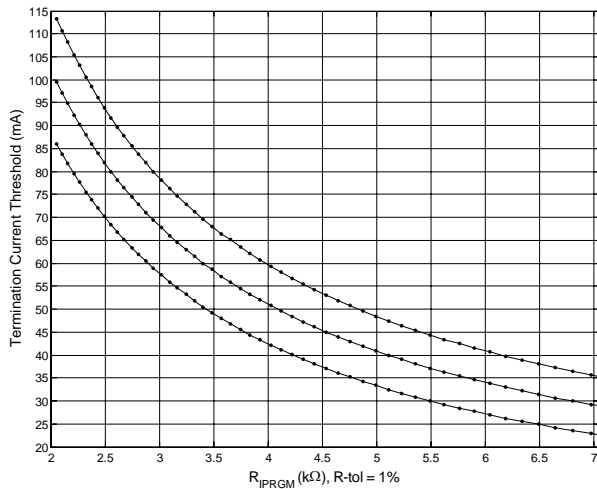

Figure 3a — Termination Current Tolerance versus Programming Resistance, Low Resistance Range

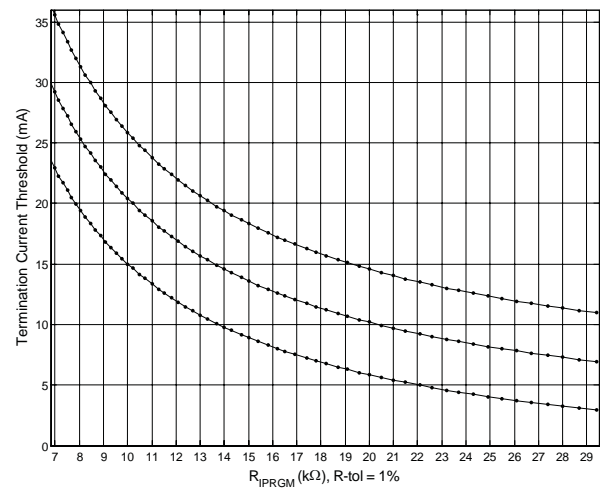

Figure 3b — Termination Current Tolerance versus Programming Resistance, High Resistance Range

plots are derived from models of the expected worst-case contribution of error sources depending on programmed current. The current range includes the uncertainty due to a 1% tolerance resistor. The dots on each plot indicate the currents obtained with standard value 1% tolerance resistors. Figures 3a and 3b show low and high resistance ranges, respectively.

Enable Input

The ENB pin is a tri-level logical input that allows selection of the following behaviors:

- Charging enabled with float-charging after termination (ENB = low range)
- Charging enabled with float-charging disabled and battery monitoring at termination (ENB = mid range)
- Charging disabled (ENB = high range).

This input is designed to interface to a processor GPIO port powered from a peripheral supply voltage as low as 1.8V or as high as a fully charged battery. While a connected GPIO port is configured as an output, the processor writes a 0 to select ENB low-range, and 1 to select high-range. The GPIO port is configured as an input to select mid-range.

ENB can also be permanently grounded to select low-range or left unconnected to select mid-range if it will not be necessary to change the level selection.

The equivalent circuit looking into the ENB pin is a variable resistance, minimum 15kΩ, to an approximately 1V source. The input will float to mid range whenever the external driver sinks or sources less than 5μA, a common worst-case characteristic of a high impedance or a weak pull-up or pull-down GPIO configured as an input. The driving GPIO must be able to sink or source at least 75μA to ensure a low or high state, respectively, although the drive current is typically far less. (See the Electrical Characteristics table.)

If the ENB input voltage is permitted to float to mid-range, the charger is enabled but it will turn off its output following charge termination and will enter the monitor state. This state is explained in the next section. Mid-range can be selected either by floating the input (sourcing or sinking less than 5μA) or by being externally forced such that V_{ENB} falls within the midrange limits specified in the Electrical Characteristics table.

When driven low ($V_{ENB} < \text{Max } V_{IL}$), the charger is enabled and will continue to float-charge the battery following termination. If the charger is already in monitor state following a previous termination, it will exit the monitor state and begin float-charging.

When ENB is driven high ($V_{ENB} > \text{Min } V_{IH}$), the charger is disabled and the ENB input pin enters a high impedance state, suspending tri-level functionality. The specified high level input current I_{IH} is required only until a high

Applications Information (continued)

level is recognized by the SC820 internal logic. The tri-level float circuitry is then disabled and the ENB input becomes high impedance. Once forced high, the ENB pin will not float to mid range. To restore tri-level operation, the ENB pin must first be pulled down to mid or low range (at least to $V_{ENB} < \text{Max } V_{IM}$), then, if desired, released (by reconfiguring the GPIO as an input) to select mid-range. If the ENB GPIO has a weak pull-down when configured as an input, then it is unnecessary to drive ENB low to restore tri-level operation; simply configure the GPIO as an input. When the ENB selection changes from high-range to mid- or low-range, a new charge cycle begins and STATB goes low.

Note that if a GPIO with a weak pull-up input configuration is used, its pull-up current will flow from the GPIO into the ENB pin while it is floating to mid-range. Since the GPIO is driving a 1V equivalent voltage source through a resistance (looking into ENB), this current is small – possibly less than $1\mu\text{A}$. Nevertheless, this current is drawn from the GPIO peripheral power supply and, therefore, from the battery after termination. (See the next section, Monitor State.) For this reason, it is preferable that the GPIO chosen to operate the ENB pin should provide a true high impedance (CMOS) configuration or a weak pull-down when configured as an input. When pulled below the float voltage, the ENB pin output current is sourced from VAD or VUSB, not from the battery.

Monitor State

If the ENB pin is floating, the charger output and STATB pin will turn off and the device will enter the monitor state when a charge cycle is complete. If the battery voltage falls below the re-charge threshold ($V_{CV} - V_{ReQ}$) while in the monitor state, the charger will automatically initiate a re-charge cycle. The battery leakage current during monitor state is no more than $1\mu\text{A}$ over temperature and typically less than $0.1\mu\text{A}$ at room temperature.

While in the monitor state, the ENB tri-level input pin remains fully active, and although in midrange, is sensitive to both high and low levels. The SC820 can be forced from the monitor state (no float-charging) directly to float-charging operation by driving ENB low. This operation will turn on the charger output, but will not assert the STATB output. If the ENB pin is again allowed to float to mid-range, the charger will remain on only until the output

current becomes less than the termination current, and charging terminates. The SC820 turns off its charging output and returns to the monitor state within a millisecond. This forced re-charge behavior is useful for periodically testing the battery state-of-charge and topping-off the battery, without float-charging and without requiring the battery to discharge to the automatic re-charge voltage. ENB should be held low for at least 1ms to ensure a successful forced re-charge.

Forced re-charge can be requested at any time during the charge cycle, or even with no charging source present, with no detrimental effect on charger operation. This allows the host processor to schedule a forced re-charge at any desired interval, without regard to whether a charge cycle is already in progress, or even whether a charging source is present. Forced re-charge will neither assert nor release the STATB output.

Status Output

The STATB pin is an open-drain output. It is asserted (driven low) as charging begins after a valid charging source is connected and the voltage on either input is between its selection and OVP limits. STATB is also asserted as charging begins after the ENB input returns to either of the enable voltage ranges (mid or low voltage) from the disable range. STATB is subsequently released when the termination current is reached to indicate end-of-charge, when the ENB input is driven high to disable charging, or when neither charging input is selected and valid to charge. If the battery is already fully charged when a charge cycle is initiated, STATB is asserted for approximately $750\mu\text{s}$ before being released. The STATB pin is not asserted for automatic re-charge cycles.

The STATB pin may be connected to an interrupt input to notify a host controller of the charging status or it can be used as an LED driver.

Logical CC-to-CV Transition

The SC820 differs from monolithic linear single cell Li-ion chargers that implement a linear transition from CC to CV regulation. The linear transition method uses two simultaneous feedback signals — output voltage and output current — to the closed-loop controller. When the output voltage is sufficiently below the CV regulation voltage, the influence of the voltage feedback is negligible and the

Applications Information (continued)

output current is regulated to the desired current. As the battery voltage approaches the CV regulation voltage (4.2V), the voltage feedback signal begins to influence the control loop, which causes the output current to decrease although the output voltage has not reached 4.2V. The output voltage limit dominates the controller when the battery reaches 4.2V and eventually the controller is entirely in CV regulation. The soft transition effectively reduces the charge current below that which is permitted for a portion of the charge cycle, which increases charge time.

In the SC820, a logical transition is implemented from CC to CV to recover the charge current lost due to the soft transition. The controller regulates only current until the output voltage exceeds the transition threshold voltage. It then switches to CV regulation. The transition voltage from CC to CV regulation is typically 5mV higher than the CV regulation voltage, which provides a sharp and clean transition free of chatter between regulation modes. The difference between the transition voltage and the regulation voltage is termed the CC/CV overshoot. While in CV regulation, the output current sense remains active. If the output current exceeds by 5% the programmed fast-charge current, the controller reverts to current regulation.

The logical transition from CC to CV results in the fastest possible charging cycle that is compliant with the specified current and voltage limits of the Li-ion cell. The output current is constant at the CC limit, then decreases abruptly when the output voltage steps from the overshoot voltage to the regulation voltage at the transition to CV control.

Thermal Limiting

Device thermal limiting is the third output constraint of the Constant Current, Constant Voltage, “Constant” Temperature (CC/CV/CT) control. This feature permits a higher input OVP threshold, and thus the use of higher voltage or poorly regulated adapters. If high input voltage results in excessive power dissipation, the output current is reduced to prevent overheating of the SC820. The thermal limiting controller reduces the output current by $i_T \approx 50\text{mA}/^\circ\text{C}$ for any junction temperature $T_J > T_{TL}$.

When thermal limiting is inactive,

$$T_J = T_A + V_{\Delta} I_{FQ} \theta_{JA}$$

where V_{Δ} is the voltage difference between the VIN pin and the BAT pin. However, if T_J computed this way exceeds T_{TL} , then thermal limiting will become active and the thermal limiting regulation junction temperature will be

$$T_{JTL} = T_A + V_{\Delta} I(T_{JTL}) \theta_{JA}$$

where

$$I(T_{JTL}) = I_{FQ} - i_T (T_{JTL} - T_{TL})$$

Combining these two equations and solving for T_{JTL} , the steady state junction temperature during active thermal limiting is

$$T_{JTL} = \frac{T_A + V_{\Delta} (I_{FQ-x} + i_T T_{TL}) \theta_{JA}}{1 + V_{\Delta} i_T \theta_{JA}}$$

Although the thermal limiting controller is able to reduce output current to zero, this does not happen in practice. Output current is reduced to $I(T_{JTL})$, reducing power dissipation such that die temperature equilibrium T_{JTL} is reached.

While thermal limiting is active, all charger functions remain active and the charger logical state is preserved.

Operating a Charging Adapter in Current Limit

In high charging current applications, charger power dissipation can be greatly reduced by operating the charging adapter in current limit. The SC820 VAD input supports adapter-current-limited charging with a low deselection falling threshold and with internal circuitry designed for low input voltage operation. To operate an adapter in current limit, R_{IPRGM} is chosen such that the adapter input programmed fast-charge current I_{FQ_AD} exceeds the current limit of the charging adapter I_{AD-LIM} .

Note that if I_{AD-LIM} is less than 20% of I_{FQ_AD} , then the adapter voltage can be pulled down to the battery voltage while the battery voltage is below the pre-charge threshold. In this case, care must be taken to ensure that the adapter will maintain its current limit below 20% of I_{FQ_AD} at least until the battery voltage exceeds the pre-charge threshold. Failure to do so could permit charge current to exceed

Applications Information (continued)

the pre-charge current while the battery voltage is below the pre-charge threshold. This is because the low input voltage will also compress the pre-charge threshold internal reference voltage to below the battery voltage. This will prematurely advance the charger logic from pre-charge current regulation to fast-charge regulation, and the charge current will exceed the safe level recommended for pre-charge conditioning.

The low deselection falling threshold ($V_{T_{ADsel-F}}$) permits the adapter voltage to be pulled down to just above the battery voltage by the charging load whenever the adapter current limit is less than the programmed fast-charge current. The SC820 should be operated with adapter voltage below the rising selection threshold ($V_{T_{ADsel-R}}$) only if the low input voltage is the result of adapter current limiting. This implies that the VAD voltage first exceeds $V_{T_{ADsel-R}}$ to begin charging, and is subsequently pulled down to just above the battery voltage by the charging load.

Interaction of Thermal Limiting and Current Limited Adapter Charging

To permit the charge current to be limited by the adapter, it is necessary that the adapter input fast-charge current be programmed greater than the maximum adapter current, (I_{AD-LIM}). In this configuration, the CC regulator will operate with its pass device fully on (in saturation, also called “dropout”). The voltage drop from VAD to BAT is determined by the product of the minimum R_{DS-ON} of the pass device multiplied by the adapter supply current.

In dropout, the power dissipation in the SC820 is $P_{ILIM} = (\text{minimum } R_{DS-ON}) \times (I_{AD-LIM})^2$. Since minimum R_{DS-ON} does not vary with battery voltage, dropout power dissipation is constant throughout the CC portion of the charge cycle while the adapter remains in current limit. The SC820 junction temperature will rise above ambient by $P_{ILIM} \times \theta_{JA}$. If the device temperature rises to the temperature at which the thermal limiting control loop limits charging current (rather than the current being limited by the adapter), the input voltage will rise to the adapter regulation voltage. The power dissipation will increase so that the thermal limit regulation will further limit charge current. This will keep the adapter in voltage regulation for the remainder of the charge cycle.

To ensure that the adapter remains in current limit, the internal device temperature must never rise to T_{TL} . This implies that θ_{JA} must be kept small enough to ensure that $T_J = T_A + (P_{ILIM} \times \theta_{JA}) < T_{TL}$.

VUSB Under-Voltage Load Regulation

VUSB pin UVLR prevents the battery charging current from overloading the USB Vbus network, regardless of the programmed fast-charge value. When the VUSB input is selected, the SC820 monitors the input voltage (V_{VUSB}) and reduces the charge current as necessary to keep V_{VUSB} at or above the UVLR limit ($V_{VUSB_UV_LIM}$). UVLR operates like a fourth output constraint (along with CC, CV, and CT constraints), but it is active only when the VUSB input is selected.

If the VUSB voltage is externally pulled below $V_{VUSB_UV_LIM}$ while the VAD input is absent, the UVLR feature will reduce the charging current to zero. This condition will not be interpreted as termination and will not result in an end-of-charge indication. The STATB pin will remain asserted as if charging is continuing. This prevents repetitive indications of end-of-charge alternating with start-of-charge in the case that the external VUSB load is removed or is intermittent.

Short Circuit Protection

The SC820 can tolerate a BAT pin short circuit to ground indefinitely. The current into a ground short is approximately 10mA.

During charging, a short to ground applied to the active current programming pin (IPRGM or IPUSB) is detected, while a short to ground on the inactive programming pin is ignored. Pin-short detection on an active current programming pin forces the SC820 into reset, turning off the output. A pin-short on either programming pin will prevent startup regardless of the charging input selected. When the IPRGM or IPUSB pin-short condition is removed, the charger begins normal operation automatically without input power cycling.

Over-Current Protection

Over-current protection is provided in all modes of operation, including CV regulation. The output current is limited to either the pre-charge or the fast-charge current (as

Applications Information (continued)

programmed by IPRGM or IPUSB, determined by input selection), depending on the voltage at the output.

Input Over-Voltage Protection

The VAD and VUSB input pins are protected from over-voltage to at least 30V above GND. When the voltage of the selected input exceeds the Over-Voltage Protection (OVP) rising threshold ($V_{T_{OVP-R}}$), charging is halted. When the input voltage falls below the OVP falling threshold ($V_{T_{OVP-F}}$), charging resumes. Note that the VAD input remains selected even in the case that the VAD voltage exceeds the OVP threshold. An excessive VAD voltage will disable charging despite the presence of a valid VUSB voltage. An OVP fault turns off the STATB output. STATB is turned on again when charging restarts.

The OVP threshold has been set relatively high to permit the use of poorly regulated adapters. Such adapters may output a high voltage until loaded by the charger. A too-low OVP threshold could prevent the charger from ever turning on and loading the adapter to a lower voltage. If the adapter voltage remains high despite the charging load, the fast thermal limiting feature will immediately reduce the charging current to prevent overheating of the SC820. This behavior is illustrated in Figure 4, in which $V_{BAT} = 3.0V$, $I_{FQ} = 700mA$, and V_{VAD} is stepped from 0V to 8.1V. Initially, power dissipation in the SC820 is 3.6W.

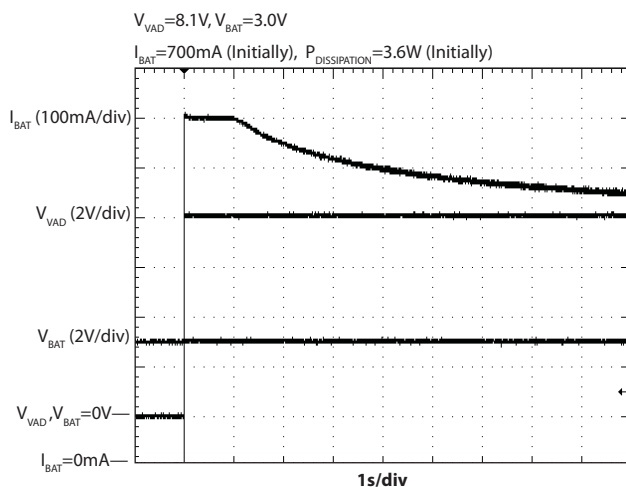

Figure 4 — Thermal Limiting Example

Notice the BAT output current is rapidly reduced to limit the internal die temperature, then continues to decline as the circuit board gradually heats up, further reducing the conduction of heat from the die to the ambient environ-

ment. In this experiment, the final steady-state BAT current was 462mA at $T_A = 25C$ on the SC820 evaluation board. The fast thermal limiting feature ensures compliance with CCSA YD/T 1591-2006, *Telecommunication Industrial Standard of the People's Republic of China — Technical Requirements and Test Method of Charger and Interface for Mobile Telecommunication Terminal*, Section 4.2.3.1.

Operation Without a Battery

The SC820 can be operated as a 4.2V LDO regulator without the battery present, for example, factory testing. If this use is anticipated, the output capacitance C_{BAT} should be at least 2.2 μF to ensure stability. To operate the charger without a battery, the ENB pin must be driven low or grounded.

Capacitor Selection

Low cost, low ESR ceramic capacitors such as the X5R and X7R dielectric material types are recommended. The BAT pin capacitor range is 1 μF to 22 μF . The VAD pin and VUSB input capacitors are typically between 0.1 μF and 2.2 μF , although larger values will not degrade performance. Capacitance must be evaluated at the expected bias voltage, rather than the zero-volt capacitance rating.

PCB Layout Considerations

Layout for linear devices is not as critical as for a switching regulator. However, careful attention to detail will ensure reliable operation.

- Place input and output capacitors close to the device for optimal transient response and device behavior.
- Connect all ground connections directly to the ground plane. If there is no ground plane, connect to a common local ground point before connecting to board ground near the GND pin.
- Attaching the part to a larger copper footprint will enable better heat transfer from the device, especially on PCBs with internal ground and power planes.

Design Considerations — USB Charging

The USB specification restricts the load on the USB Vbus power network to 100mA for low power devices and for

Applications Information (continued)

high power devices prior to granting permission for high power operation. The specification restricts the Vbus load to 500mA for high power devices after granting permission to operate as a high power device. This suggests that a fixed 1:5 ratio of low power to high power charging current is desirable. But this can result in suboptimal charging when the battery capacity is too small to permit fast charging at 500mA. For example, a 250mAh battery will typically require a fast-charge current of 250mA or less. A fixed 1:5 ratio for USB low and high power charging will unnecessarily reduce charging current to 50mA, well below the 100mA permitted.

An arbitrary ratio of USB low-to-high power charging currents can be obtained using an external n-channel FET operated with a processor GPIO signal to engage a second parallel IPUSB resistor. The external circuit is illustrated in Figure 5.

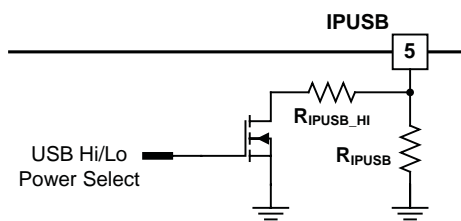

Figure 5 — External programming of arbitrary USB high power and low power charge currents.

For USB low power mode charging, the external transistor is turned off. The transistor is turned on when high power mode is desired. The effect of the switched parallel IPUSB resistor is to reduce the effective programming resistance and thus raise the fast-charge current.

An open-drain GPIO can be used directly to engage the parallel resistor R_{IPUSB_HI} . Care must be taken to ensure that the R_{DS-ON} of the GPIO is considered in the selection of R_{IPUSB_HI} . Also important is the part-to-part and temperature variation of the GPIO R_{DS-ON} and their contribution to the USB High Power charge current tolerance. Note also that IPUSB will be pulled up briefly to as high as 3V during startup to check for an IPUSB static pinshort to ground. A small amount of current could, potentially, flow from IPUSB into the GPIO ESD structure through R_{IPUSB_HI} during

this event. While unlikely to do any harm, this effect must also be considered.

For purposes of design for dual-input adapter/USB charging, a small battery is one with a desired fast-charge current less than 500mA. A 300mAh battery with maximum fast-charge current of 300mA is an example. The adapter input and USB input high power fast-charge currents should both be set to 300mA max. The USB input low power fast-charge current is 100mA max. Refer to the circuit of Figure 4 and the data of Figures 1a and 1b. For $I_{FQ_AD} = 300\text{mA max}$, use $R_{IPRGM} = 7.50\text{k}\Omega$. The fixed IPUSB resistor of $R_{IPUSB} = 23.2\text{k}\Omega$ programs $I_{FQ_USB} = 100\text{mA max}$. When parallel resistor $R_{IPUSB_HI} = 11.0\text{k}\Omega$ is switched in, the equivalent IPUSB resistor is $7.50\text{k}\Omega$, and so $I_{FQ_USB} = 300\text{mA max}$.

A large battery is any battery with a desired fast-charge current exceeding 500mA. Large battery charging is most consistent with the USB fixed 1:5 current ratio low-to-high power model of operation. For example, consider an 800mAh battery, with maximum fast-charge current of 800mA. The adapter input fast-charge should be configured for 800mA max ($R_{IPRGM} = 2.80\text{k}\Omega$), the USB low power fast-charge set to 100mA max ($R_{IPUSB} = 23.2\text{k}\Omega$), and the USB high power fast-charge set to 500mA max ($R_{IPUSB_HI} = 5.62\text{k}\Omega$).

USB Low Power Mode Alternative

Where a USB mode selection signal is not available, or where system cost or board space make USB low power mode external current programming impractical, USB low power charging can be supported indirectly. The IPUSB pin resistance can be selected to obtain the desired USB high power charge current. The VUSB pin UVLR feature ensures that the charging load will never pull the USB Vbus supply voltage below $V_{USB_UV_LIM}$ regardless of the USB host or hub supply limit. The UVLR limit voltage guarantees that the voltage of the USB Vbus supply will not be loaded below the low power voltage specification limit, as seen by any other low power devices connected to the same USB host or hub.

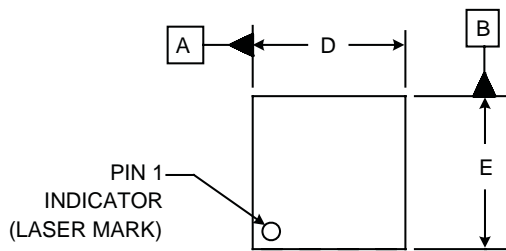
Outline Drawing — MLPD-UT8 2x2

DIM	DIMENSIONS					
	INCHES			MILLIMETERS		
	MIN	NOM	MAX	MIN	NOM	MAX
A	.020	-	.024	0.50	-	0.60
A1	.000	-	.002	0.00	-	0.05
A2	(.006)			(0.1524)		
b	.007	.010	.012	0.18	0.25	0.30
D	.075	.079	.083	1.90	2.00	2.10
D1	.061	.067	.071	1.55	1.70	1.80
E	.075	.079	.083	1.90	2.00	2.10
E1	.026	.031	.035	0.65	0.80	0.90
e	.020 BSC			0.50 BSC		
L	.012	.014	.016	0.30	0.35	0.40
N	8			8		
aaa	.003			0.08		
bbb	.004			0.10		

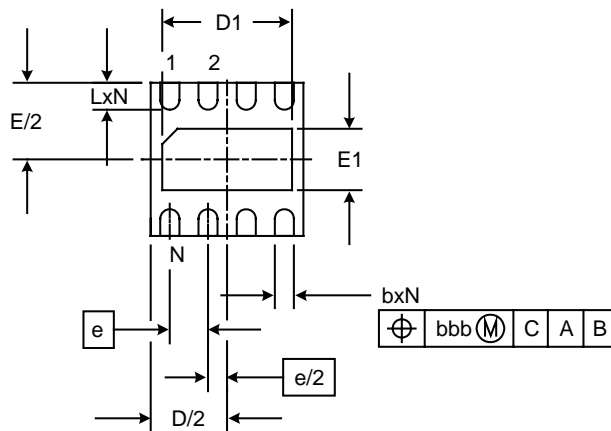
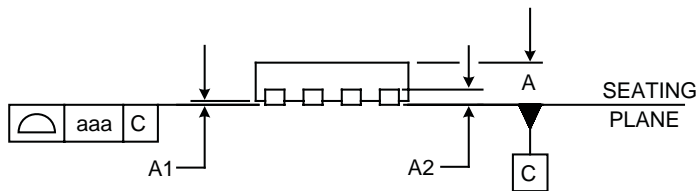
NOTES:

1. CONTROLLING DIMENSIONS ARE IN MILLIMETERS (ANGLES IN DEGREES).
2. COPLANARITY APPLIES TO THE EXPOSED PAD AS WELL AS THE TERMINALS.

Land Pattern — MLPD-UT8 2x2

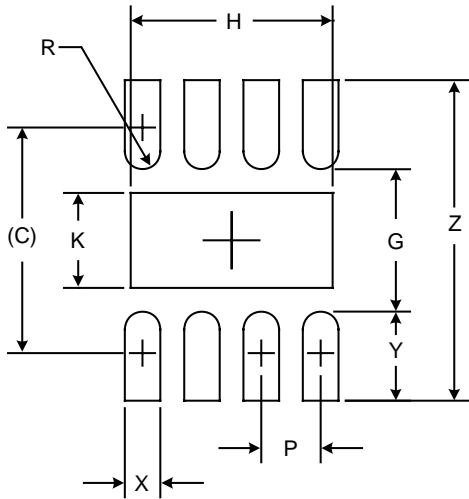

DIMENSIONS		
DIM	INCHES	MILLIMETERS
C	(.077)	(1.95)
G	.047	1.20
H	.067	1.70
K	.031	0.80
P	.020	0.50
R	.006	0.15
X	.012	0.30
Y	.030	0.75
Z	.106	2.70

NOTES:

1. CONTROLLING DIMENSIONS ARE IN MILLIMETERS (ANGLES IN DEGREES).
2. THIS LAND PATTERN IS FOR REFERENCE PURPOSES ONLY. CONSULT YOUR MANUFACTURING GROUP TO ENSURE YOUR COMPANY'S MANUFACTURING GUIDELINES ARE MET.
3. THERMAL VIAS IN THE LAND PATTERN OF THE EXPOSED PAD SHALL BE CONNECTED TO A SYSTEM GROUND PLANE. FAILURE TO DO SO MAY COMPROMISE THE THERMAL AND/OR FUNCTIONAL PERFORMANCE OF THE DEVICE.

Contact Information

Semtech Corporation
 Power Management Products Division
 200 Flynn Road, Camarillo, CA 93012
 Phone: (805) 498-2111 Fax: (805) 498-3804

www.semtech.com