

Features

- N-Channel enhancement mode device
- DMOS structure
- Lower capacitances for broadband operation
- High saturated output power
- Lower noise figure than bipolar devices

ABSOLUTE MAXIMUM RATINGS AT 25° C

Parameter	Symbol	Rating	Units
Drain-Source Voltage	V_{DS}	65	V
Gate-Source Voltage	V_{GS}	20	V
Drain-Source Current	I_{DS}	1.4	A
Power Dissipation	P_D	15.8	W
Junction Temperature	T_J	200	°C
Storage Temperature	T_{STG}	-55 to +150	°C
Thermal Resistance	θ_{JC}	11.1	°C/W

TYPICAL DEVICE IMPEDANCE

F (MHz)	$Z_{IN} (\Omega)$	$Z_{LOAD} (\Omega)$
100	15 - j121.0	57.0 + j23.0
150	39.0 - j77.0	55.0 + j23.0
175	41.0 - j38.0	56.0 + j19.0
200	34.0 - j14.0	56.0 + j20.0
$V_{DD} = 28V, I_{DQ} = 50mA, P_{OUT} = 5W$		

Z_{IN} is the series equivalent input impedance of the device from gate to source.

Z_{LOAD} is the optimum series equivalent load impedance as measured from drain to ground.

ELECTRICAL CHARACTERISTICS AT 25° C

Parameter	Symbol	Min	Max	Units	Test Conditions
Drain-Source Breakdown Voltage	BV_{DSS}	65	-	V	$V_{GS} = 0.0 V, I_{DS} = 20.0 mA$
Drain-Source Leakage Current	I_{DSS}	-	1.0	mA	$V_{GS} = 28.0 V, V_{DS} = 0.0 V$
Gate-Source Leakage Current	I_{GSS}	-	1.0	μA	$V_{GS} = 20.0 V, V_{DS} = 0.0 V$
Gate Threshold Voltage	$V_{GS(TH)}$	2.0	6.0	V	$V_{DS} = 10.0 V, I_{DS} = 10 mA$
Forward Transconductance	G_M	80	-	S	$V_{DS} = 10.0 V, I_{DS} = 10 mA, \Delta V_{GS} = 1.0 V, 80 \mu s$ Pulse
Input Capacitance	C_{ISS}	-	7	pF	$V_{DS} = 28.0 V, F = 1.0 MHz$
Output Capacitance	C_{OSS}	-	5	pF	$V_{DS} = 28.0 V, F = 1.0 MHz$
Reverse Capacitance	C_{RSS}	-	2.4	pF	$V_{DS} = 28.0 V, F = 1.0 MHz$
Power Gain	G_P	11	-	dB	$V_{DD} = 28.0 V, I_{DQ} = 50 mA, P_{OUT} = 5.0 W F = 175 MHz$
Drain Efficiency	η_D	55	-	%	$V_{DD} = 28.0 V, I_{DQ} = 50 mA, P_{OUT} = 5.0 W F = 175 MHz$
Load Mismatch	VSWR-T	-	20:1	-	$V_{DD} = 28.0 V, I_{DQ} = 50 mA, P_{OUT} = 5.0 W F = 175 MHz$

Package Outline

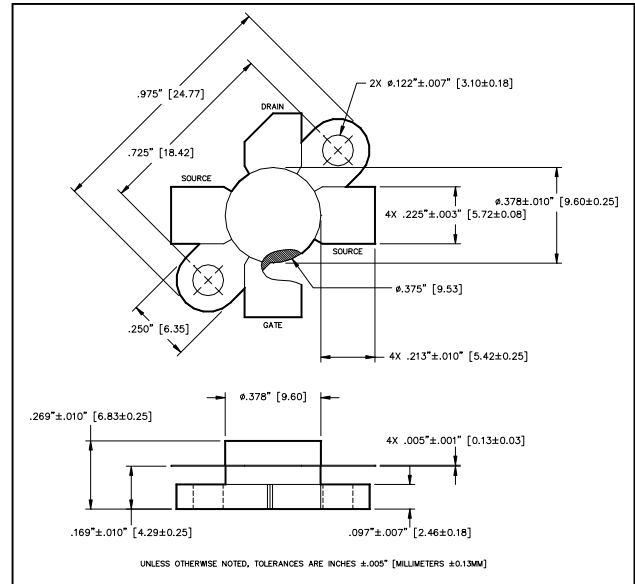

LETTER DIM	MILLIMETERS		INCHES	
	MIN	MAX	MIN	MAX
A	24.64	24.89	.970	.980
B	18.29	18.54	.720	.730
C	20.07	20.83	.790	.820
D	9.47	9.73	.373	.383
E	6.22	6.48	.245	.255
F	5.64	5.79	.222	.228
G	2.92	3.30	.115	.130
H	2.29	2.67	.090	.105
J	4.04	4.55	.159	.179
K	6.58	7.39	.259	.291
L	.10	.15	.004	.006

Typical Broadband Performance Curves

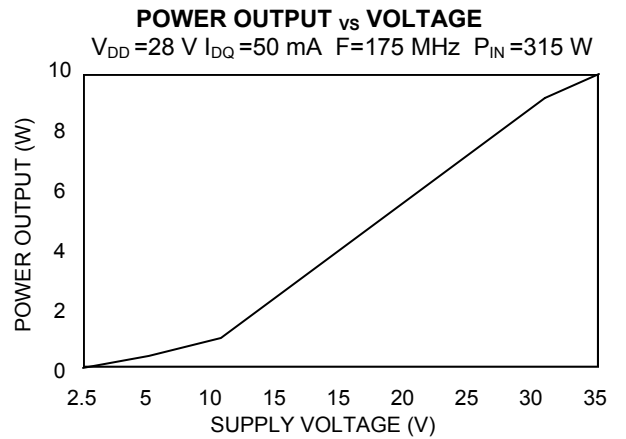
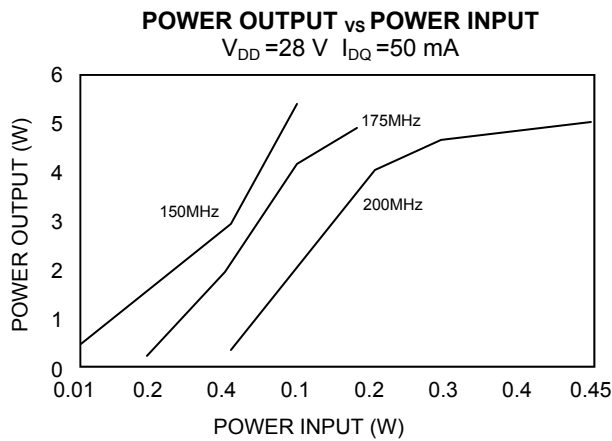
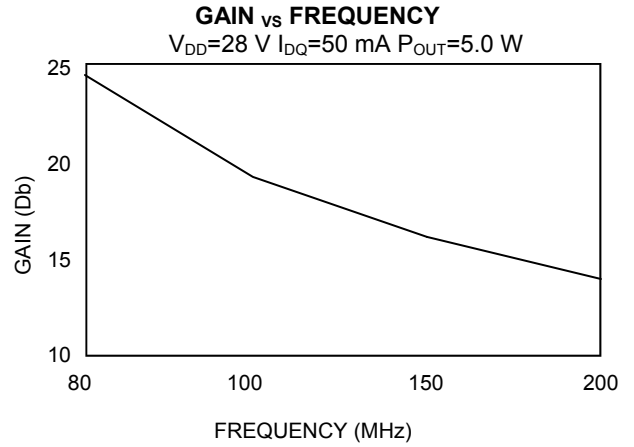
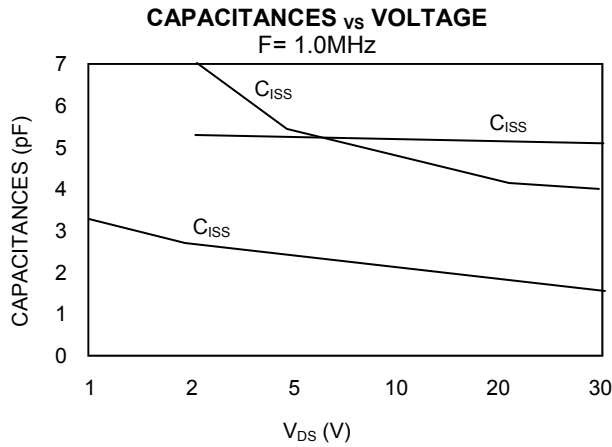

TEST FIXTURE SCHEMATIC

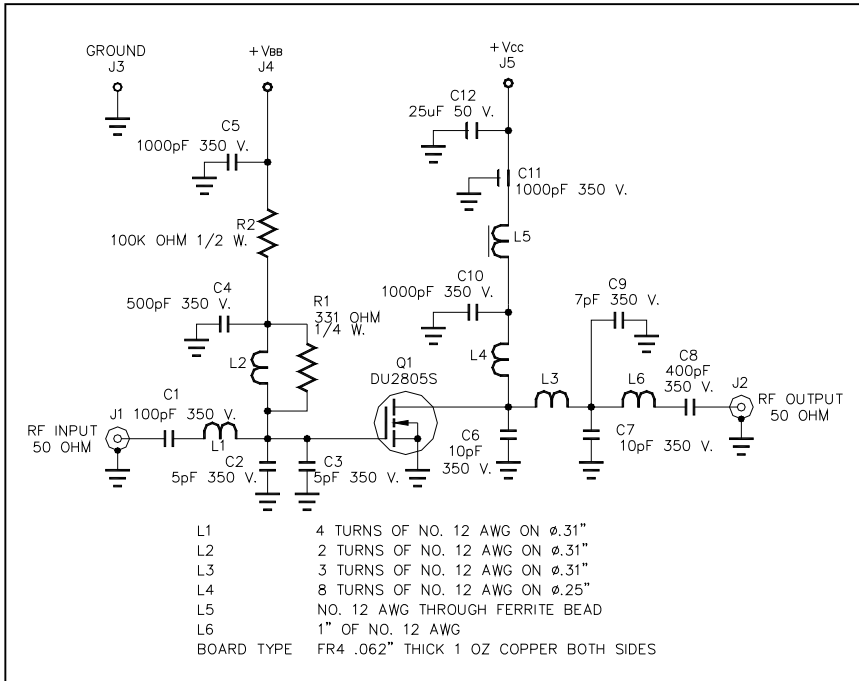

TEST FIXTURE ASSEMBLY

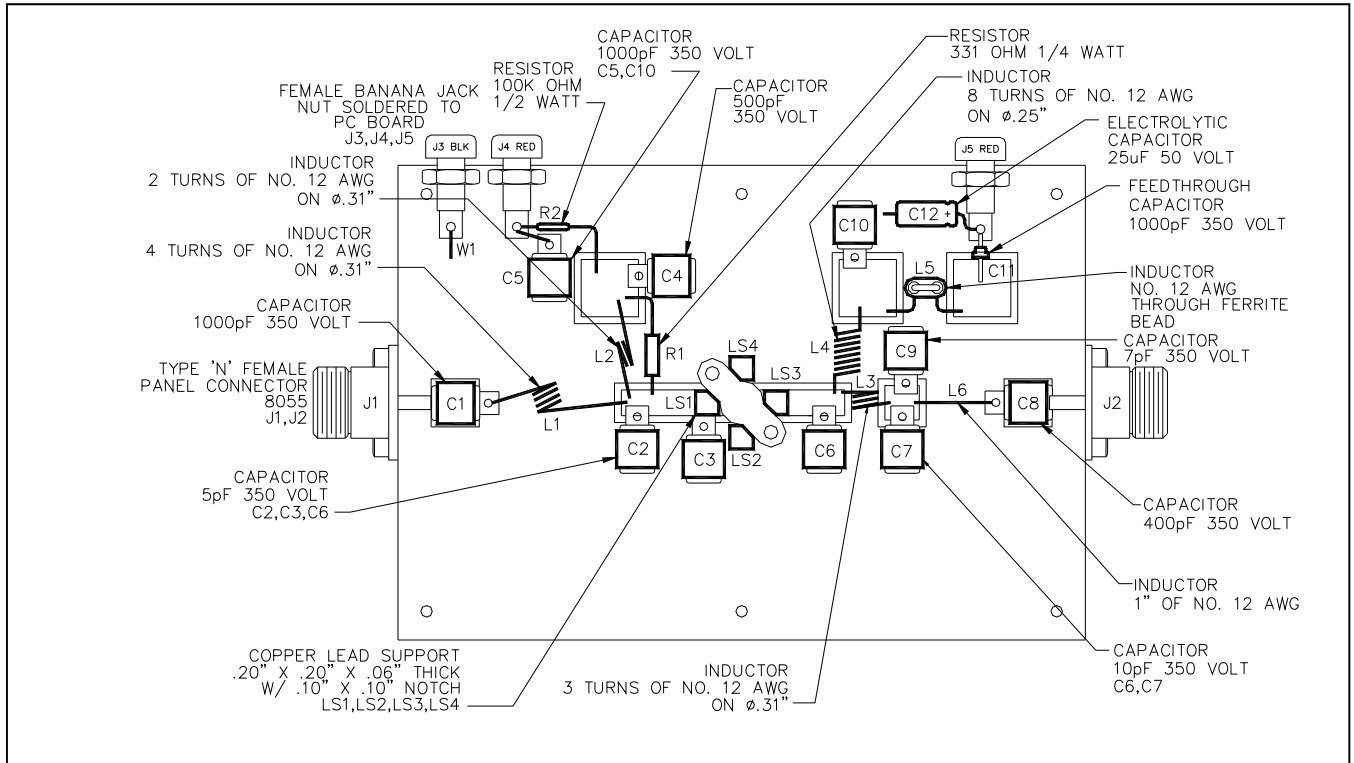

ADVANCED: Data Sheets contain information regarding a product M/A-COM Technology Solutions is considering for development. Performance is based on target specifications, simulated results, and/or prototype measurements. Commitment to develop is not guaranteed.
PRELIMINARY: Data Sheets contain information regarding a product M/A-COM Technology Solutions has under development. Performance is based on engineering tests. Specifications are typical. Mechanical outline has been fixed. Engineering samples and/or test data may be available. Commitment to produce in volume is not guaranteed.

- **North America** Tel: 800.366.2266 / Fax: 978.366.2266
- **Europe** Tel: 44.1908.574.200 / Fax: 44.1908.574.300
- **Asia/Pacific** Tel: 81.44.844.8296 / Fax: 81.44.844.8298

Visit www.macontech.com for additional data sheets and product information.

M/A-COM Technology Solutions Inc. and its affiliates reserve the right to make changes to the product(s) or information contained herein without notice.