

MPDRK-30 Kit

DIN Rail Mounting Kit For Modular Chassis Mount, 30W AC/DC Power Supplies



Key Features (Kit + Module):

- 30W Output Power
- Universal 85-265 VAC Input
- DIN Rail Mounting
- Compact Encapsulated Module
- EN60950 Approved
- Single, Dual & Triple Outputs
- Meets EN55022 B

Kit adapts the MPM-30CM (modular 30W, chassis mount power supplies) series for use with a DIN rail.

PC Board Mount Models Available!

Chassis Mount Models Available!



Kit includes mounting plate, Din Rail clip and all required screws.

MicroPower Direct

292 Page Street
Suite D
Stoughton, MA 02072
USA

T: (781) 344-8226

F: (781) 344-8481

E: sales@micropowerdirect.com

W: www.micropowerdirect.com



Din Rail Clip

Mounting Plate (Aluminum)

AC/DC Module

Mechanical Dimensions, DIN Mount Kit

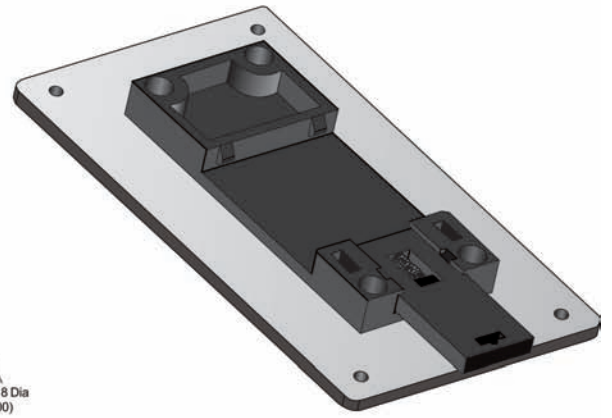
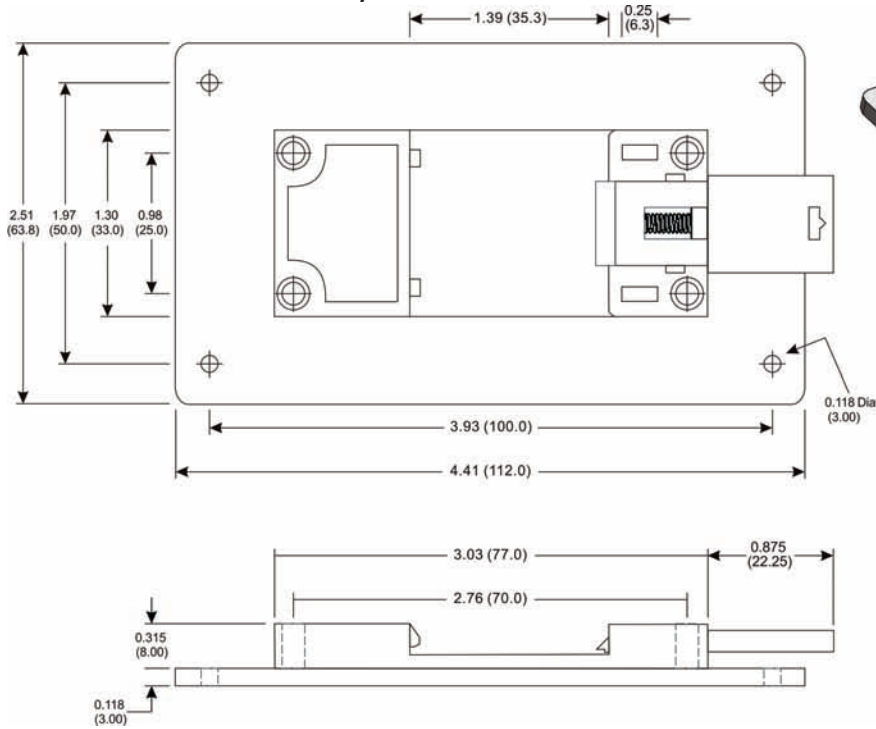

Mechanical Dimensions, Module/DIN Rail Mount Assembly

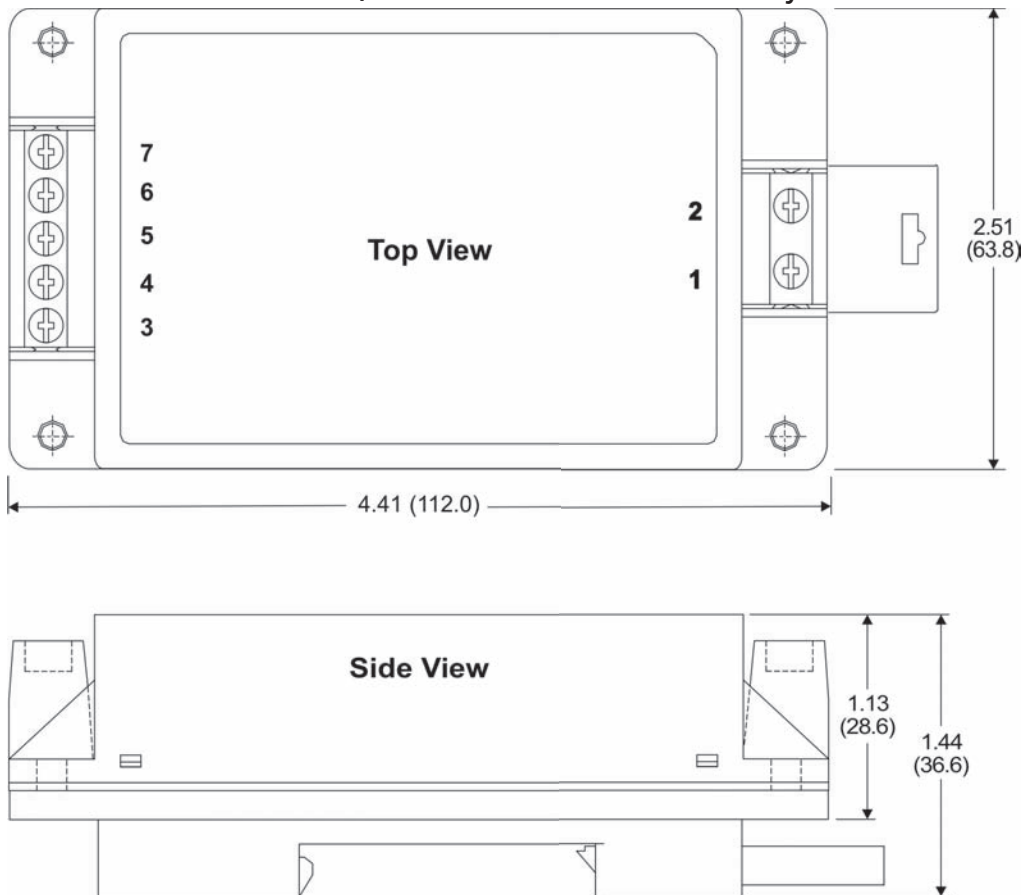

Ordering Information

Kit No.	For Models
MPDRK-30	MPM-30CM Series

Pin Connection

Pin	Single	Dual	Triple
1		AC-Neutral	
2		AC-Line	
3	+Vo	+Vo	+Vo 2
4	NC	NC	+Vo 1
5	-Vo	Common	Common 2/3
6	NC	NC	-Vo 1
7	NC	-Vo	+Vo 3

NC = No Connection



MicroPower Direct
www.micropowerdirect.com

Notes:

- All dimensions are typical in inches (mm)
- Tolerance x.xx = ±0.01 (±0.25)