

Push Switch Surface Mount Type Push Switch

SPEF Series

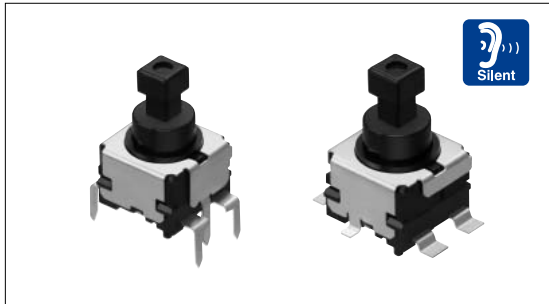

Surface mountable lead-free soldering push switch.



Typical Specifications

Items	Specifications
Rating (max) (Resistive load)	1A 14.5V DC
Initial contact resistance	100m max.
Operating force	3N,5N
Operating life(Without load)	30,000cycles
Poles-Positions	1-pole,2-positions

Product Line

Changeover timing	Travel (mm)	Total travel (mm)	Operating force	Mounting method	Operating	Terminal type	Minimum order unit (pcs.)	Product No.	Drawing No.
Non shorting	1.5	2.7	3N	PC board	Latching	Reflow	1,320	SPEF210101	1
						Dip	2,100	SPEF110100	2
			5N			Reflow	1,320	SPEF210200	1
						Dip	2,100	SPEF110200	2

Taping Specifications (Taping Packaging)

Reel Size Unit:mm

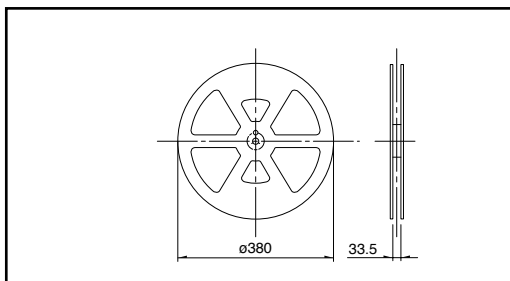

Number of packages(pcs.)			Tape width (mm)
1 reel	1 case /Japan	1 case /export packing	
165	660	1,320	32

Note

Please place purchase orders per minimum order unit (integer).

Detector

Push

Slide

Rotary

Encoders

Power

Dual-in-line
Package Type

TACT Switch™

Custom-
Products

Horizontal
Type

Vertical
Type

Dimensions

Unit:mm

No.	Style	PC board mounting hole dimensions
1	<p>Reflow Soldering Type</p>	
	<p>Dip Soldering Type</p>	







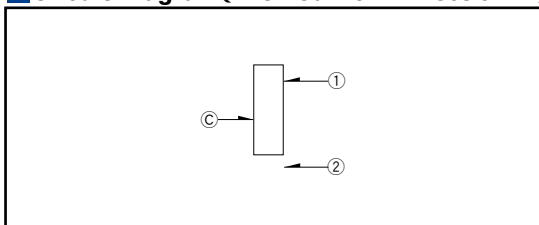

- Detector
- Push**
- Slide
- Rotary
- Encoders
- Power
- Dual-in-line Package Type
- TACT Switch™
- Custom-Products

- Horizontal Type
- Vertical Type**

Circuit Diagram (Viewed from Direction A)



List of Varieties

Series		SPPH4	SPPH1	SPEC	SPED2	SPED3	SPED4	SPED5	SPEF		
Photo											
Travel (mm)		2.2	1.5	2.5					1.5		
Total travel (mm)		3	2.5	3.4	4.5	3.8		2.7			
Number of poles		2				1					
Dimensions (mm)	W	8.5	10	12	14			13.5	9.4		
	D	6.5	10		16.8	18		18.2	9		
	H	8.5		12.5	26.7	20.7			6.9		
Operating temperature range		- 10°C to + 60°C			- 40°C to + 85°C						
Rating (max.) (Resistive load)		0.1A 30V DC				1A 14.5V DC					
Rating (min.) (Resistive load)		50μA 3V DC									
Electrical performance	Initial contact resistance	100m max.	20m max.	30m max.	100m max.						
	Insulation resistance	100M min. 500V DC				3M min. 500V DC			3M min. 100VDC		
	Voltage proof	500V AC for 1minute				100V AC for 1minute					
Mechanical performance	Terminal strength	5N for 1minute		3N for 1minute							
	Actuator strength	Operating direction	30N	50N				90N			
Pulling direction		10N		50N					30N		
Durability	Operating life without load	10,000cycles 100m max.	10,000cycles 40m max.	10,000cycles 50m max.	30,000cycles 100m max.						
	Operating life without load Load:as rating										
Environmental performance	Cold	-20 ± 2 for 96h				-40 ± 2 for 96h					
	Dry heat	85 ± 2 for 96h									
	Damp heat	40 ± 2 , 90 to 95%RH for 96h									
Soldering	Manual soldering	350 ± 10 3 ⁺¹ ₀ s			350 ± 10 3 ± 0.5s	3	350 ± 10 3 ± 0.5s		350 ± 5 3s max.		
	Dip soldering	260 ± 5 5 ± 1s	260 ± 5 10 ± 1s	260 max. 5s max.	260 ± 5 10 ± 1s	3	260 ± 5 10 ± 1s		260 ± 5 10 ± 1s	4	
	Reflow soldering									Please see P.108	
Page		98	99	101	102	103		105			

Detector

Push

Slide

Rotary

Encoders

Power

Dual-in-line
Package Type

TACT Switch™

Custom-
Products

Horizontal
Type

Vertical
Type

Push Switches Attached Parts107
 Push Switches Products Caution109

Notes

3. Applicable to SPED220200(PC board type)only.
4. Applicable to SPEF110100 only.

Soldering Conditions

Example of Reflow Soldering Condition

1. Heating method: Double heating method with infrared heater.
2. Temperature measurement: Thermocouple 0.1 to 0.2 CA (K) or CC (T) at soldering portion (copper foil surface). A heat resisting tape should be used for fixed measurement.
3. Temperature profile

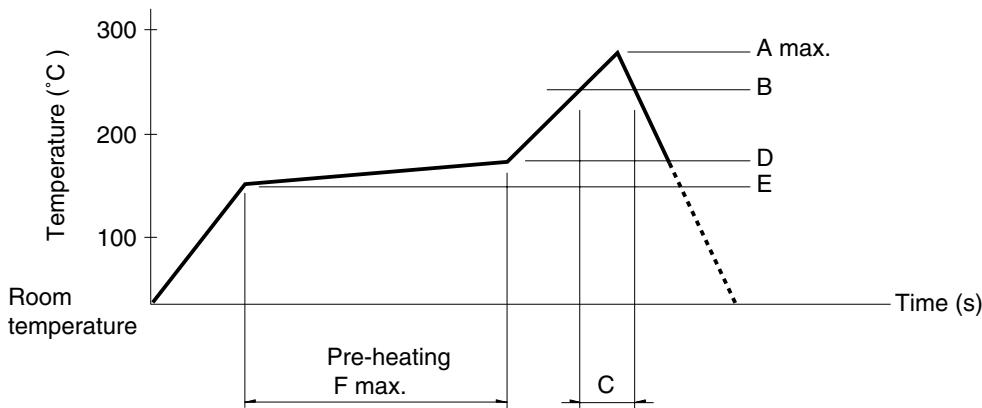

Series(Reflow type)	A() 3s max.	B()	C(s)	D()	E()	F(s)
SPEE	260	230	40	180	150	120
SPEF, SPEG						

Notes

1. The condition mentioned above is the temperature on the mounting surface of a PC board. There are cases where the PC board's temperature greatly differs from that of the switch, depending on the PC board's material, size, thickness, etc. The above-stated conditions shall also apply to switch surface temperatures.
2. Soldering conditions differ depending on reflow soldering machines. Prior verification of soldering condition is highly recommended.

- Detector
- Push**
- Slide
- Rotary
- Encoders
- Power
- Dual-in-line Package Type
- TACT Switch™
- Custom-Products

- Horizontal Type
- Vertical Type