

**500mW Zener Diode Series**

# ZD5221ASH thru ZD5260ASH

**Description**

The ZD5221ASH thru ZD5260ASH series covers zener voltage range from 2.4V to 43V, and is encapsulated in SOD-123 package, very suitable for low cost, low power voltage regulation application.

**Features**

- $V_Z$  tolerance :  $\pm 2\%$
- Ultra small surface mount package
- General purpose, medium current
- Planar die construction
- Pb-free lead plating and halogen-free package

**Symbol**

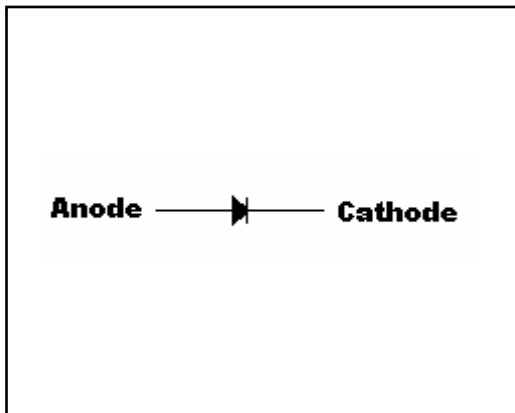

**Outline**

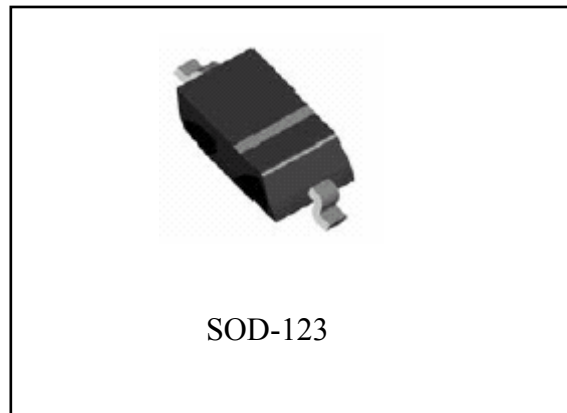

**Absolute Maximum Ratings**( $T_j=25^\circ\text{C}$ , unless otherwise specified)

- Maximum Temperatures  
 Operating and Storage Temperature Range  $T_j, T_{stg}$  ..... -65~+150 °C
- Maximum Forward Voltage @  $I_F=10\text{mA}$  ..... 0.9V
- Maximum Power Dissipation  
 Total Power Dissipation @  $T_L=75^\circ\text{C}$   $P_{tot}$  (Note 1) ..... 500 mW
- Thermal Resistance, Junction to Ambient Air  $R_{\theta JL}$  (Note 1)..... 150°C/W
- Maximum Z-current.....  $P_{tot}/V_Z$  mA

Note : 1. Parts mounted on FR-5 board with area of 3.5inch  $\times$  1.5inch.

**Electrical Characteristic** (Ta=25°C, unless otherwise noted)

Device	Type Code	Nom. Zener Voltage			Max. Zener Impedance				Max. Zener Current	Max. Reverse Leakage Current	
		Vz@IzT (V)			ZzT	IzT	ZzK	IzK	IzM@Ta	IR	VR
		Nom.	Min.	Max.	(Ω)	(mA)	(Ω)	(mA)	(mA)	(μA)	(V)
ZD5221A	C1	2.4	2.35	2.45	30	20	1200	0.25	188	100	1.0
ZD5223A	C3	2.7	2.65	2.75	30	20	1300	0.25	167	75	1.0
ZD5225A	C5	3.0	2.94	3.06	30	20	1600	0.25	150	50	1.0
ZD5226A	G1	3.3	3.23	3.37	28	20	1600	0.25	138	25	1.0
ZD5227A	G2	3.6	3.53	3.67	24	20	1700	0.25	126	15	1.0
ZD5228A	G3	3.9	3.82	3.98	23	20	1900	0.25	115	10	1.0
ZD5229A	G4	4.3	4.21	4.39	22	20	2000	0.25	106	5.0	1.0
ZD5230A	G5	4.7	4.61	4.79	19	20	1900	0.25	97	5.0	2.0
ZD5231A	E1	5.1	5.00	5.20	17	20	1600	0.25	89	5.0	2.0
ZD5232A	E2	5.6	5.49	5.71	11	20	1600	0.25	81	5.0	3.0
ZD5233A	E3	6.0	5.88	6.12	7.0	20	1600	0.25	76	5.0	3.5
ZD5234A	E4	6.2	6.08	6.32	7.0	20	1000	0.25	73	5.0	4.0
ZD5235A	E5	6.8	6.66	6.94	5.0	20	750	0.25	67	3.0	5.0
ZD5236A	F1	7.5	7.35	7.65	6.0	20	500	0.25	61	3.0	6.0
ZD5237A	F2	8.2	8.04	8.36	8.0	20	500	0.25	55	3.0	6.5
ZD5238A	F3	8.7	8.53	8.87	8.0	20	600	0.25	55	3.0	6.5
ZD5239A	F4	9.1	8.92	9.28	10	20	600	0.25	50	3.0	7.0
ZD5240A	F5	10	9.80	10.20	17	20	600	0.25	45	3.0	8.0
ZD5241A	H1	11	10.78	11.22	22	20	600	0.25	41	2.0	8.4
ZD5242A	H2	12	11.76	12.24	30	20	600	0.25	38	1.0	9.1
ZD5243A	H3	13	12.74	13.26	13	9.5	600	0.25	35	0.5	9.9
ZD5245A	H5	15	14.70	15.30	16	8.5	600	0.25	30	0.1	11
ZD5246A	J1	16	15.68	16.32	17	7.8	600	0.25	28	0.1	12
ZD5248A	J3	18	17.64	18.36	21	7.0	600	0.25	25	0.1	14
ZD5250A	J5	20	19.60	20.40	25	6.2	600	0.25	23	0.1	15
ZD5251A	K1	22	21.56	22.44	29	5.6	600	0.25	21	0.1	17
ZD5252A	K2	24	23.52	24.48	33	5.2	600	0.25	19.1	0.1	18
ZD5254A	K4	27	26.46	27.54	41	5.0	600	0.25	16.8	0.1	21
ZD5255A	K5	28	27.44	28.56	44	4.5	600	0.25	16.2	0.1	21
ZD5256A	M1	30	29.40	30.60	49	4.2	600	0.25	15.1	0.1	23
ZD5257A	M2	33	32.34	33.66	58	3.8	700	0.25	13.8	0.1	25
ZD5258A	M3	36	35.28	36.72	70	3.4	700	0.25	12.6	0.1	27
ZD5259A	M4	39	38.22	39.78	80	3.2	800	0.25	11.6	0.1	30
ZD5260A	M5	43	42.14	43.86	93	3	900	0.25	10.6	0.1	33

**Ordering Information**

Device	Package	Shipping
ZD52XXASH	SOD-123 (Pb-free lead plating and Halogen-free package)	3000 pcs / Tape & Reel



### Characteristic Curves

Typical Temperature Coefficient

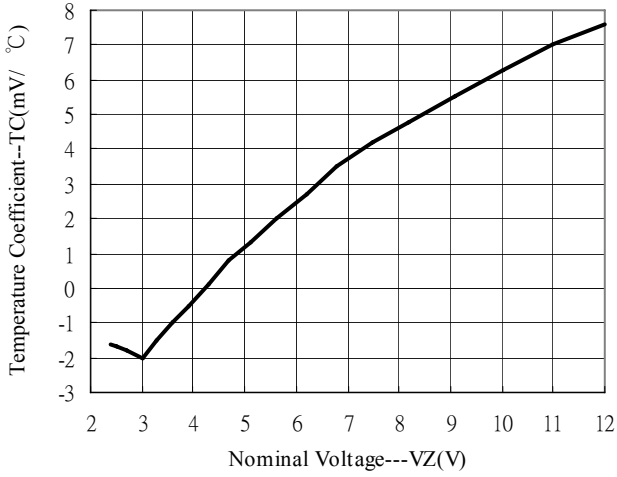

Typical Temperature Coefficient

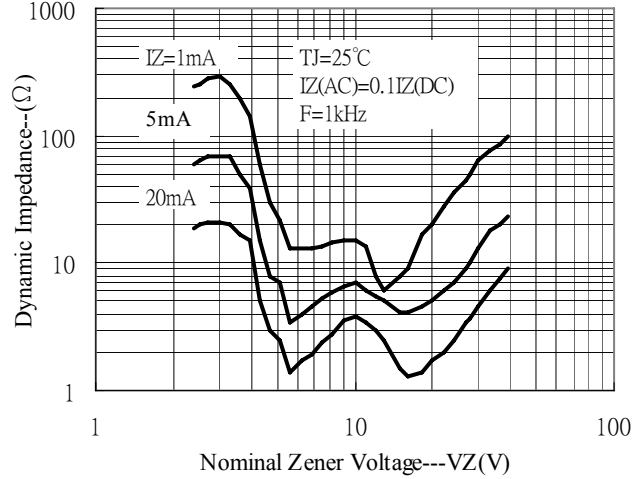

Typical Capacitance

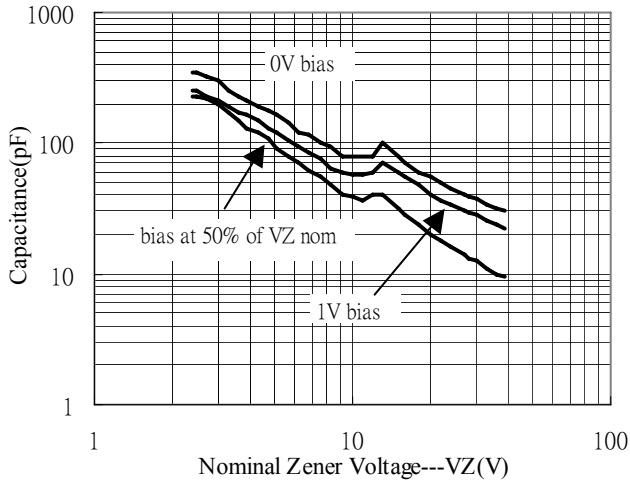

Power Derating Curve

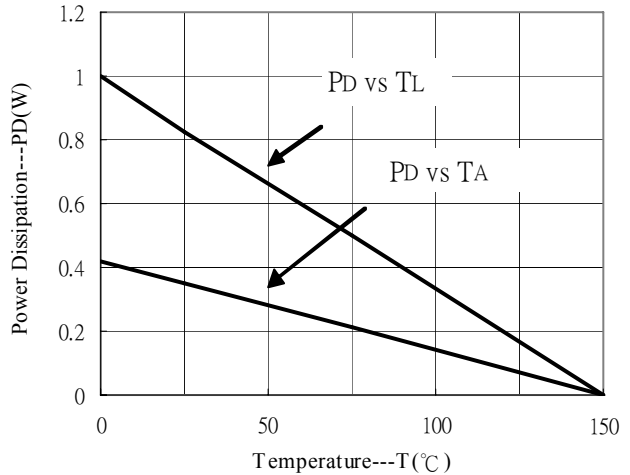

Zener Current vs Zener Voltage

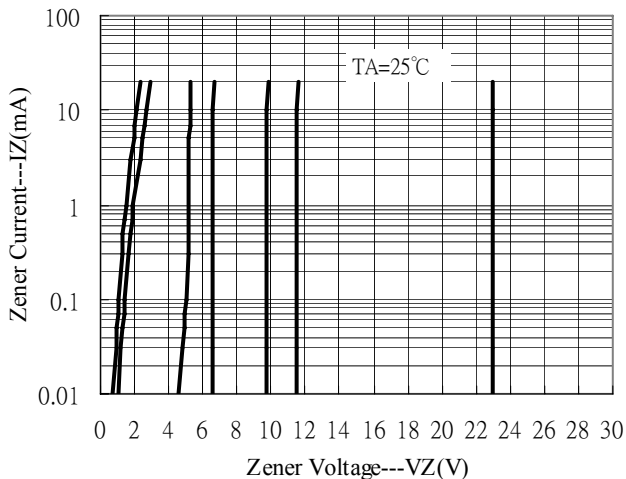

Typical Leakage Current

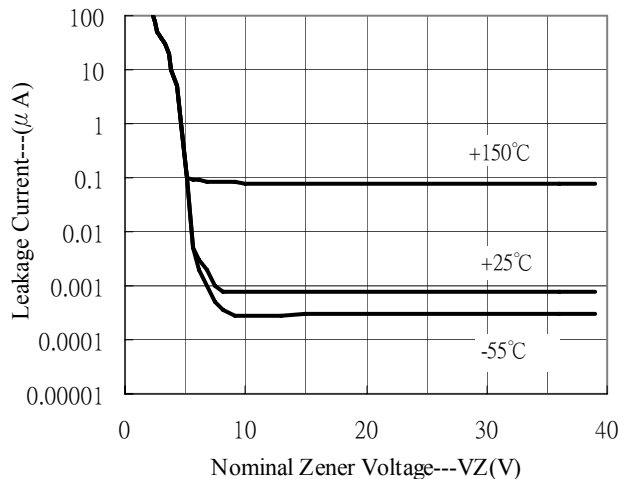

**Reel Dimension**

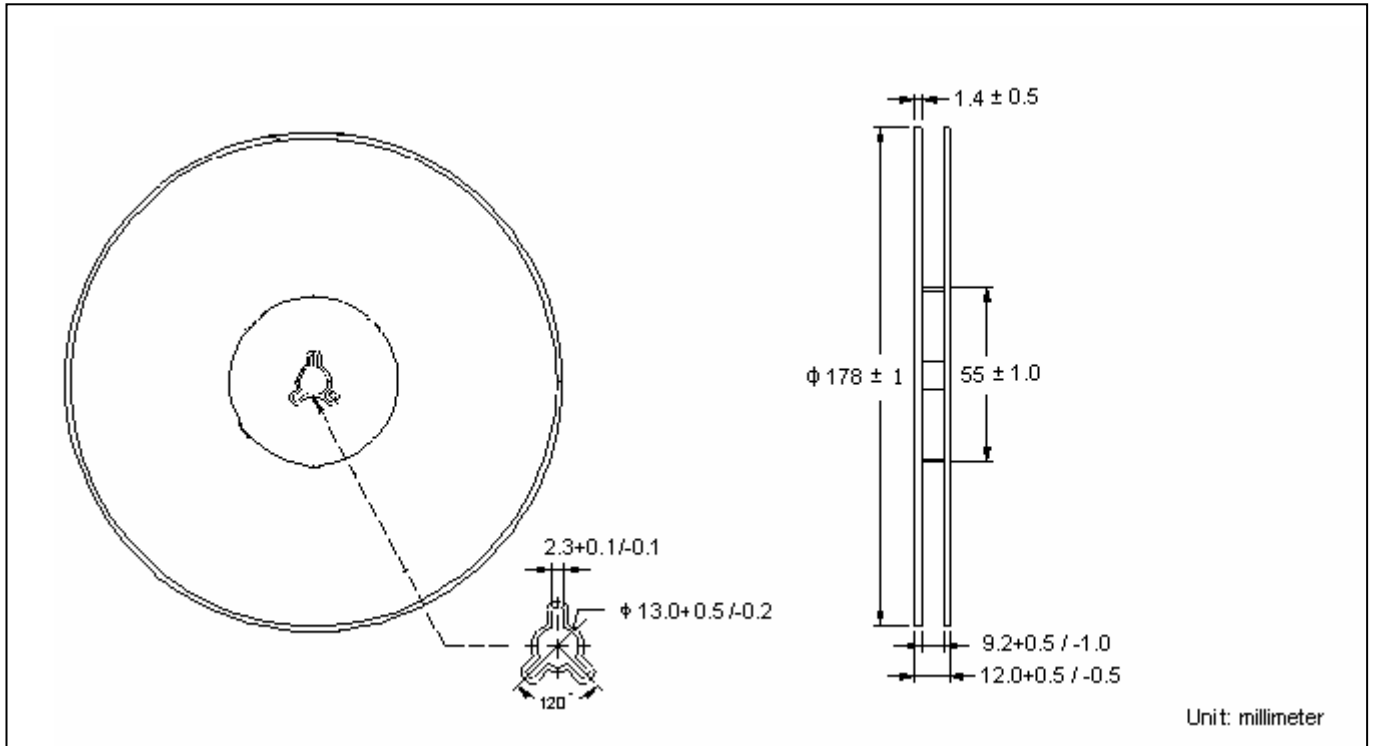

**Carrier Tape Dimension**

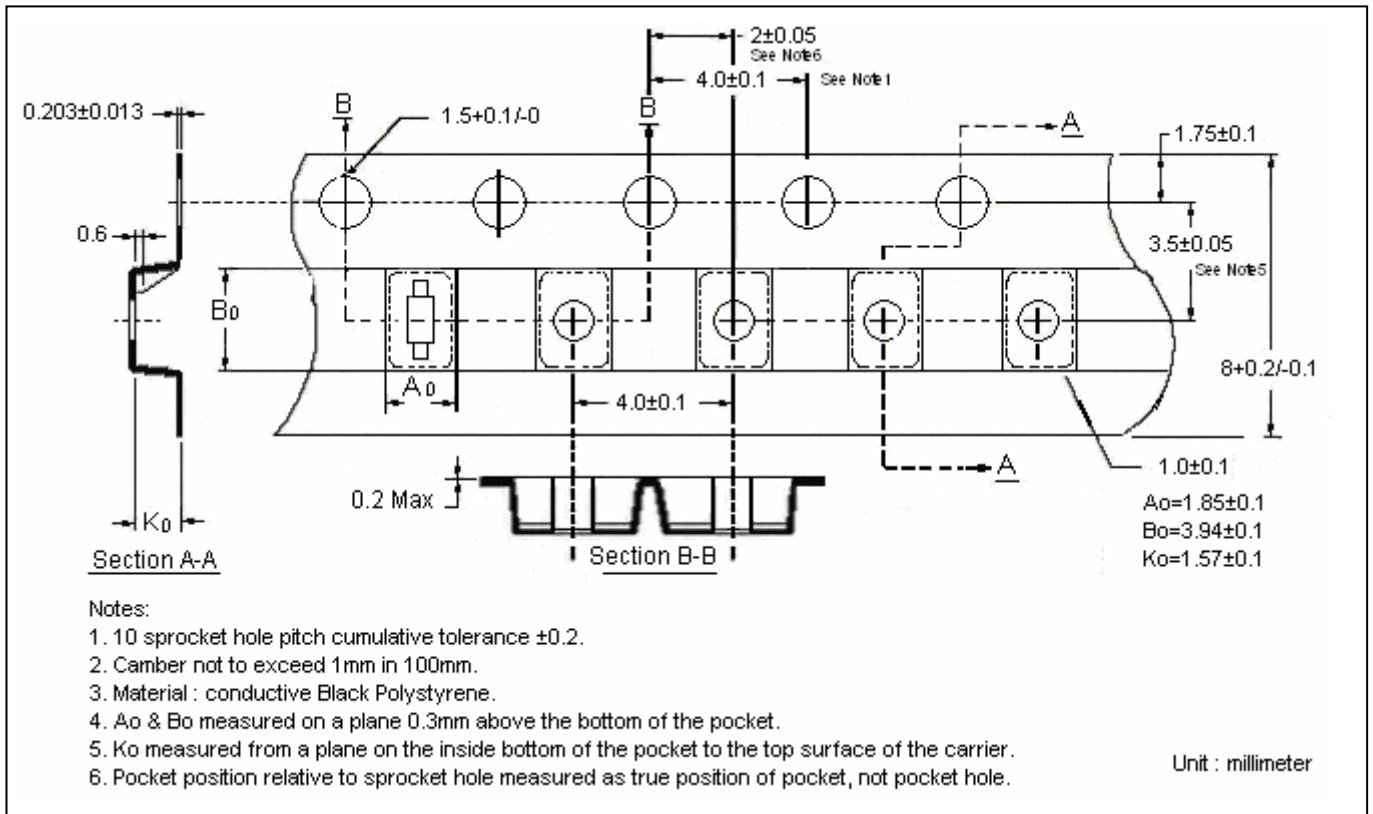

**Recommended wave soldering condition**

Product	Peak Temperature	Soldering Time
Pb-free devices	260 +0/-5 °C	5 +1/-1 seconds

**Recommended temperature profile for IR reflow**

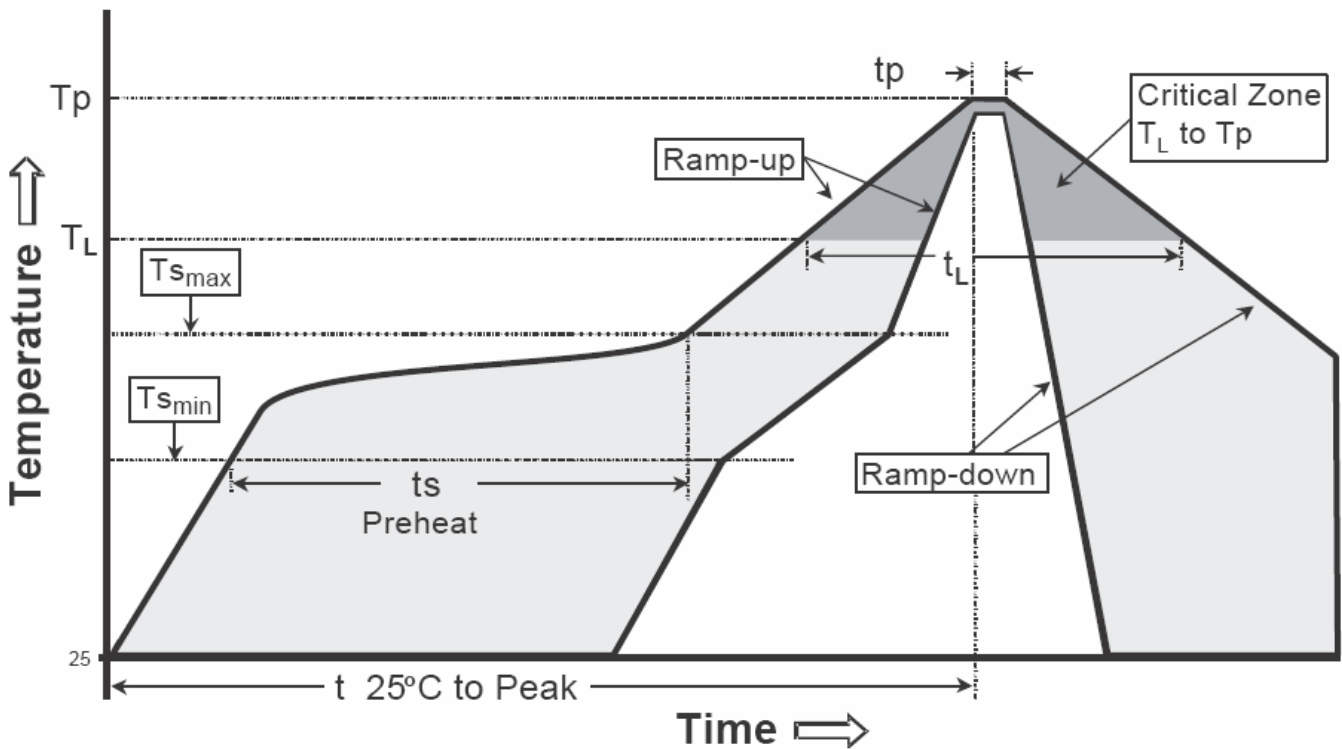

Profile feature	Sn-Pb eutectic Assembly	Pb-free Assembly
Average ramp-up rate (T <sub>smax</sub> to T <sub>p</sub> )	3°C/second max.	3°C/second max.
Preheat		
-Temperature Min(T <sub>s min</sub> )	100°C	150°C
-Temperature Max(T <sub>s max</sub> )	150°C	200°C
-Time(t <sub>s min</sub> to t <sub>s max</sub> )	60-120 seconds	60-180 seconds
Time maintained above:		
-Temperature (T <sub>L</sub> )	183°C	217°C
- Time (t <sub>L</sub> )	60-150 seconds	60-150 seconds
Peak Temperature(T <sub>P</sub> )	240 +0/-5 °C	260 +0/-5 °C
Time within 5°C of actual peak temperature(tp)	10-30 seconds	20-40 seconds
Ramp down rate	6°C/second max.	6°C/second max.
Time 25 °C to peak temperature	6 minutes max.	8 minutes max.

Note : All temperatures refer to topside of the package, measured on the package body surface.

**SOD-123 Dimension**

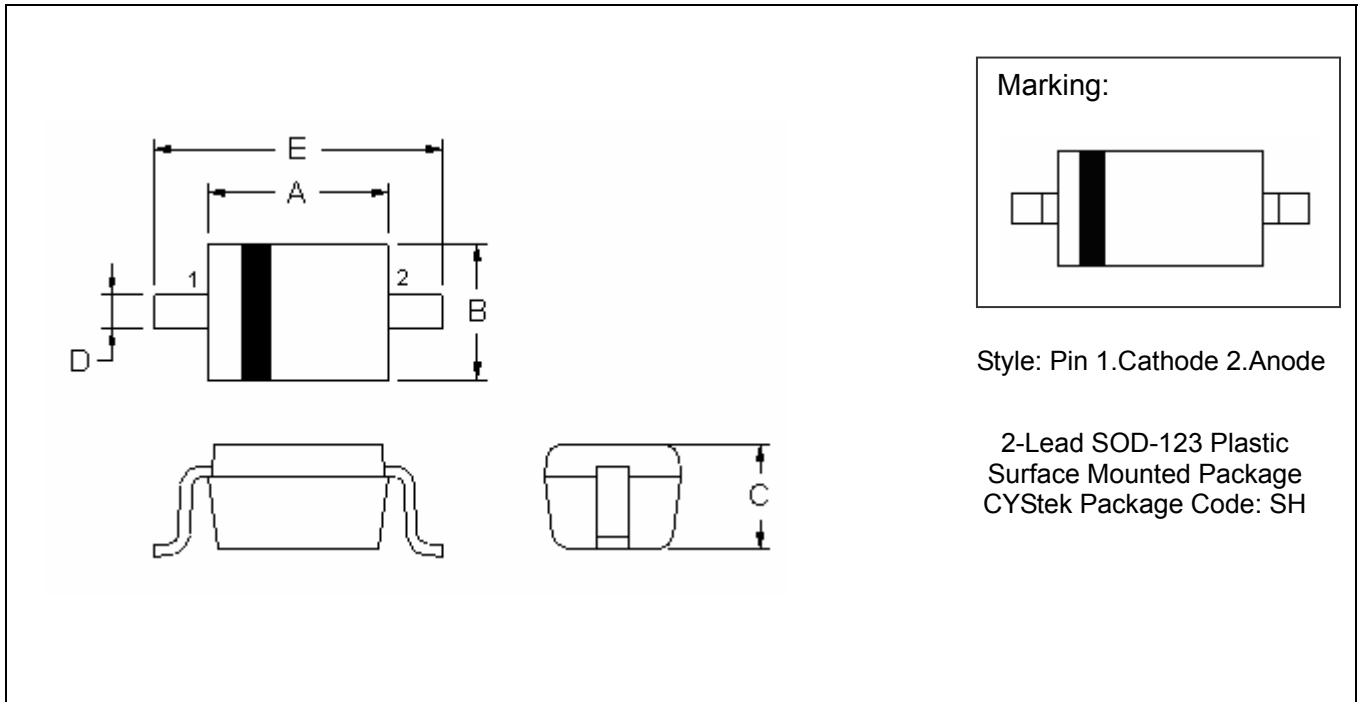

\*: Typical

DIM	Inches		Millimeters		DIM	Inches		Millimeters	
	Min.	Max.	Min.	Max.		Min.	Max.	Min.	Max.
A	0.102	0.110	2.600	2.800	E	0.140	0.152	3.550	3.850
B	0.059	0.067	1.500	1.700					
C	0.041	0.049	1.050	1.250					
D	0.018	0.026	0.450	0.650					

**Notes:** 1.Controlling dimension : millimeters.  
 2.Lead thickness specified per L/F drawing with solder plating.  
 3.If there is any question with packing specification or packing method, please contact your local CYStek sales office.

**Material:**

- Lead: Pure tin plated
- Mold Compound: Epoxy resin family, flammability solid burning class: UL94V-0

**Important Notice:**

- All rights are reserved. Reproduction in whole or in part is prohibited without the prior written approval of CYStek.
- CYStek reserves the right to make changes to its products without notice.
- CYStek **semiconductor products are not warranted to be suitable for use in Life-Support Applications, or systems.**
- CYStek assumes no liability for any consequence of customer product design, infringement of patents, or application assistance.