

RoHS  HF **SL Lo Rho Battery Strap Series**

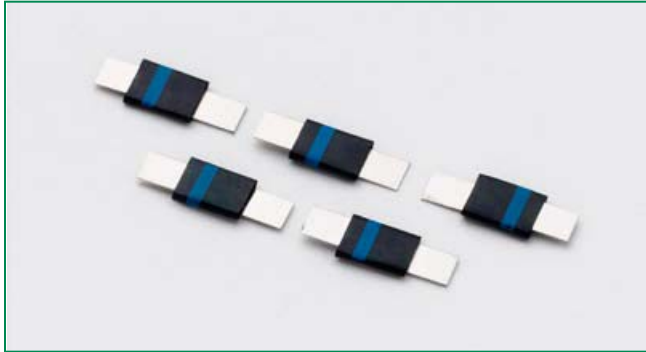

Description

The new Littelfuse SL LoRho Battery Strap Series PPTC (polymer positive temperature coefficient) is designed with a proprietary conductive polymer material, to provide both over-current and over-temperature protection for rechargeable battery cells. This series features a slim, low profile and low resistance design to install directly on the latest generations of battery cells for a longer battery run time.



Features

- Low Profile
- Lo Rho (low resistance at normal operating hold current)
- Installs Directly on battery cell
- RoHS Compliant, lead-free and halogen-free



Applications

- Rechargeable battery cell protection

Agency Approvals

AGENCY	AGENCY FILE NUMBER
	E183209
	R50119583

Electrical Characteristics

Part Number	I _{hold} (A)	I _{trip} (A)	V _{max} (Vdc)	I _{max} (A)	P _d max. (W)	Maximum Time To Trip		Resistance			Agency Approvals	
						Current (A)	Time (Sec.)	R _{min} (Ω)	R _{max} (Ω)	R _{1max} (Ω)		
06SL190G	1.9	4.9	6	50	1.0	9.5	3.00	0.006	0.013	0.024	X	X

I_{hold} = Hold current: maximum current device will pass without tripping in 25°C still air.
 I_{trip} = Trip current: minimum current at which the device will trip in 25°C still air.
 V_{max} = Maximum voltage device can withstand without damage at rated current (I_{max})
 I_{max} = Maximum fault current device can withstand without damage at rated voltage (V_{max})
 P_d = Power dissipated from device when in the tripped state at 25°C still air.
 R_{min} = Minimum resistance of device in initial (un-soldered) state.
 R_{max} = Maximum resistance of device in initial (un-soldered) state.
 R_{1max} = Maximum resistance of device at 25°C measured one hour after tripping
Caution: Operation beyond the specified rating may result in damage and possible arcing and flame.

Temperature Derating

Part Number	Ambient Operation Temperature								
	-40°C	-20°C	0°C	25°C	40°C	50°C	60°C	70°C	85°C
	Hold Current (A)								
06SL190G	3.40	3.00	2.60	1.90	1.70	1.40	1.20	1.00	0.70

SL Lo Rho Series

Average Time Current Curves

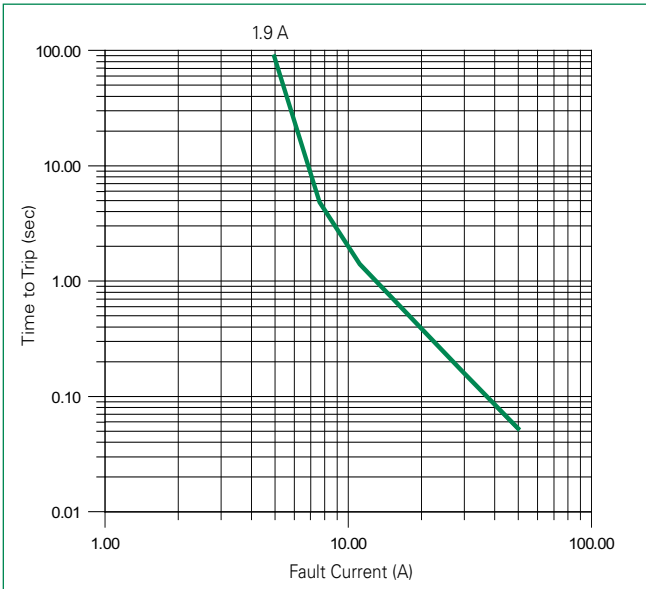

Temperature Derating Curve

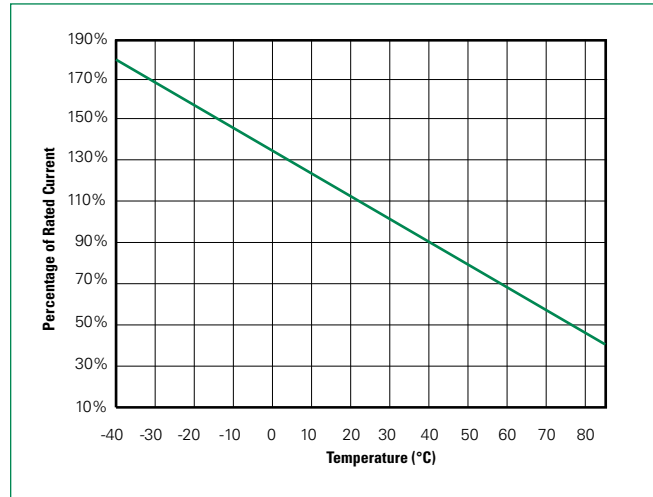

Order Numbering System

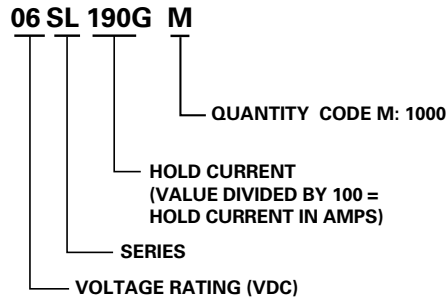

Dimensions (mm)

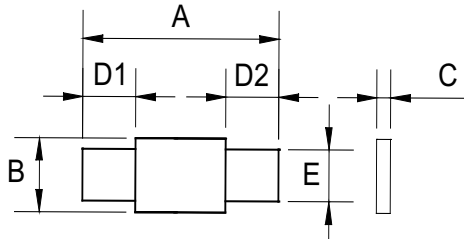

Part Number	A				B				C				D1				D2				E			
	Inches		mm		Inches		mm		Inches		mm		Inches		mm		Inches		mm		Inches		mm	
	Min.	Max.	Min.	Max.	Min.	Max.	Min.	Max.	Min.	Max.	Min.	Max.	Min.	Max.	Min.	Max.	Min.	Max.	Min.	Max.	Min.	Max.	Min.	Max.
06SL190G	0.36	0.43	9.2	10.8	0.12	0.14	3.15	3.45	0.02	0.04	0.55	0.95	0.09	0.13	2.15	3.25	0.09	0.13	2.15	3.25	0.087	0.094	2.2	2.4

Packaging

Part Number	Ordering Number	I _{hold} (A)	I _{hold} Code	Packaging Option Bulk	Quantity	Quantity & Packaging Code
06SL190G	06SL190GM	1.9	190	Bulk	1000	M