AKD4620B-B
AK4620B Evaluation board Rev.1

GENERAL DESCRIPTION

The AKD4620B-B is an evaluation board for the AK4620B, the 24Bit A/D & D/A converter. The AKD4620B-B can evaluate A/D converter and D/A converter separately in addition to loopback mode (A/D→D/A). The AKD4620B-B also has the digital audio interface and can achieve the interface with digital audio systems via opt-connector.

■ **Ordering guide**

AKD4620B-B --- Evaluation board for AK4620B
 (Cable for connecting with printer port of IBM-AT compatible PC and control software are packed with this. This control software does not operate on Windows NT.)

FUNCTION

- **Digital interface**
 - **DIT (AK4114): optical or BNC**
 - **DIR (AK4114): optical or BNC**
- **10pin header for serial control interface**

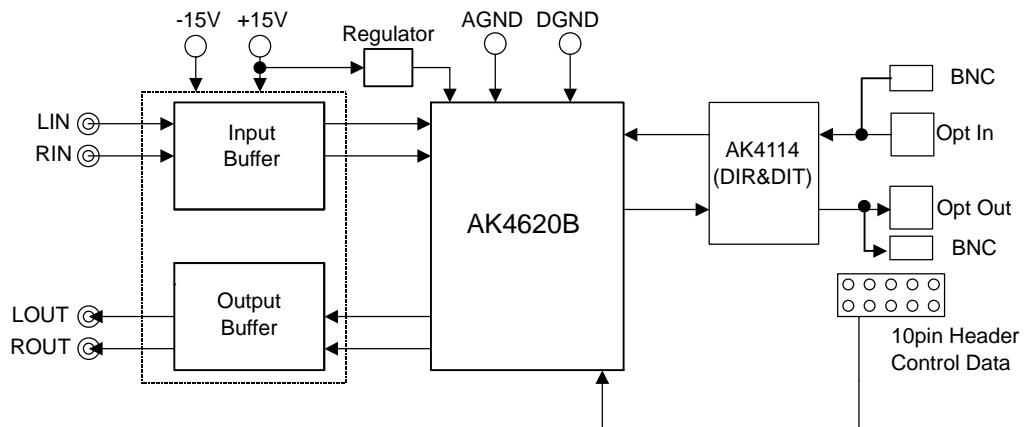

Figure 1. AKD4620B-B Block Diagram

* Circuit diagram are attached at the end of this manual.

Evaluation Board Manual

■ Operation sequence

1) Set up the power supply line

[+15V]	(green)	= +15V
[-15V]	(blue)	= -15V
[GND]	(black)	= 0V

Note: Each supply line should be distributed from the power supply unit.

2) Set up the evaluation modes, jumper pins and DIP switch. (See the followings.)

3) Power on

The AK4620B should be reset once bringing SW2 (PDN) "L" upon power-up.

■ Evaluation modes

Applicable evaluation modes

- (1) Loopback mode (Default)
- (2) Evaluation of DAC
- (3) Evaluation of ADC

1) Loopback mode (Default)

1-1) Analog input mode

Jumper	JP3 (LIN)	JP4 (AINL)	JP5 (RIN)	JP6 (AINR)	SW1-2 (ADM0DE)
Single-ended	SINGLE	SINGLE	SINGLE	SINGLE	OFF
Differential	DIFF	DIFF	DIFF	DIFF	ON

(Default)

Table 1. Analog Input Mode

* As for analog input circuit, please see the following item “Analog Input Buffer Circuit”.

1-2) Sampling speed & MCLK frequency

a) parallel mode

SW1-1 (P/S)	SW1-4 (DFS0)	SW1-6 (CKS1)	SW1-7 (CKS0)	SW3-4 (OCKS1)	SW3-5 (OCKS0)	Sampling Speed of AK4620B	MCLK Frequency of AK4620B
ON	OFF	OFF	ON	ON	OFF	Normal Speed	512fs
ON	ON	OFF	ON	OFF	OFF	Double Speed	256fs

(Default)

Table 2. Sampling Speed & Master clock Frequency in parallel mode

* Parallel mode does not support quad speed mode.

b) serial mode

SW1 (P/S)	DFS1 bit	DFS0 bit	CMODE bit	CKS1 bit	CKS0 bit	SW3-4 (OCKS1)	SW3-5 (OCKS0)	Sampling Speed of AK4620B	MCLK Frequency of AK4620B
OFF	0	0	0	0	1	ON	OFF	Normal Speed	512fs
OFF	0	1	0	0	1	OFF	OFF	Double Speed	256fs
OFF	1	0	0	0	1	ON	ON	Quad Speed	128fs

Table 3. Sampling Speed & Master clock Frequency in serial mode

* In serial mode, SW1-4(DFS0), SW1-6(CKS1) and SW1-7(CKS0) should be always “OFF”, and DFS1, DFS0, CKS1, CKS0 and CMODE bits in the AK4620B should be set via the printer port (PORT3).

1-3) AK4114's master clock mode & reference X'tal frequency

Mode	SW3-6 (CM1)	SW3-7 (CM0)	PLL	X'tal	Clock source	SDTO
1	OFF	ON	OFF	ON	X'tal	DAUX

(Default)

Table 4. AK4114'S Clock Operation Mode

SW3-1 (XTL1)	SW3-2 (XTL0)	X'tal Frequency
ON	OFF	24.576MHz

(Default)

Table 5. Reference X'tal frequency

2) Evaluation of D/A using DIR. (Optical link)

The DIR generates MCLK, BICK, LRCK and SDATA from the received data through optical connector (PORT1). PORT1 is also used for the evaluation using such as CD test disk.

BNC connector is recommended for an evaluation of the Sound quality.

2-1) DIR input interface (Default: JP2="OPT")

Jumper	JP2 (RX3)
Normal & Double Speed	OPT or BNC
Quard Speed	BNC

Table 6. DIR Input Interface

2-2) Sampling speed & MCLK frequency

a) parallel mode

SW1-1 (P/S)	SW1-4 (DFS0)	SW1-6 (CKS1)	SW1-7 (CKS0)	SW3-4 (OCKS1)	SW3-5 (OCKS0)	Sampling Speed of AK4620B	MCLK Frequency of AK4620B
ON	OFF	OFF	OFF	OFF	OFF	Normal Speed	256fs
ON	OFF	OFF	ON	ON	OFF	Normal Speed	512fs
ON	ON	OFF	ON	OFF	OFF	Double Speed	256fs

Table 7. Sampling Speed & Master clock Frequency in parallel mode

* Parallel mode does not support quad speed mode.

b) serial mode

SW1-1 (P/S)	DFS1 bit	DFS0 bit	CMODE bit	CKS1 bit	CKS0 bit	SW3-4 (OCKS1)	SW3-5 (OCKS0)	Sampling Speed of AK4620B	MCLK Frequency of AK4620B
OFF	0	0	0	0	0	OFF	OFF	Normal Speed	256fs
OFF	0	0	0	0	1	ON	OFF	Normal Speed	512fs
OFF	0	1	0	0	1	OFF	OFF	Double Speed	256fs
OFF	1	0	0	0	1	ON	ON	Quad Speed	128fs

Table 8. Sampling Speed & Master clock Frequency in serial mode

* In serial mode, SW1-4(DFS0), SW1-6(CKS1) and SW1-7(CSK0) should be always "OFF", and DFS1, DFS0, CKS1, CKS0 and CMODE bits in the AK4620B should be set via the printer port (PORT3).

2-3) AK4114's master clock mode & reference X'tal frequency

Mode	SW3-6 (CM1)	SW3-7 (CM0)	PLL	X'tal	Clock source	SDTO
0	OFF	OFF	ON	OFF	PLL	RX

Table 9. Clock Operation Mode

SW3-1 (XTL1)	SW3-2 (XTL0)	X'tal Frequency
ON	ON	OFF

Table 10. Reference X'tal frequency

3) Evaluation of A/D using DIT. (Optical link)

DIT generates audio bi-phase signal from received data and which is output through optical connector (PORT2). It is possible to connect AKM's D/A converter evaluation boards on the digital-amplifier which equips DIR input.

3-1) Analog input mode

Jumper	JP3 (LIN)	JP4 (AINL)	JP5 (RIN)	JP6 (AINR)	SW1-2 (ADM0DE)
Single-ended	SINGLE	SINGLE	SINGLE	SINGLE	OFF
Differential	DIFF	DIFF	DIFF	DIFF	ON

Table 11. Analog Input Mode

* As for analog input circuit, please see the following item "Analog Input Buffer Circuit".

3-2) DIT output interface (Default: JP7="OPT")

Jumper	JP7 (TX)
Normal & Double Speed	OPT or BNC
Quard Speed	BNC

Table 12. DIT Output Interface

3-3) Sampling speed & MCLK frequency

a) parallel mode

SW1-1 (P/S)	SW1-4 (DFS0)	SW1-6 (CKS1)	SW1-7 (CKS0)	SW3-4 (OCKS1)	SW3-5 (OCKS0)	Sampling Speed of AK4620B	MCLK Frequency of AK4620B
ON	OFF	OFF	OFF	OFF	OFF	Normal Speed	256fs
ON	OFF	OFF	ON	ON	OFF	Normal Speed	512fs
ON	ON	OFF	ON	OFF	OFF	Double Speed	256fs

Table 13. Sampling Speed & Master clock Frequency in parallel mode

* Parallel mode does not support quad speed mode.

b) serial mode

SW1-1 (P/S)	DFS1 bit	DFS0 bit	CMODE bit	CKS1 bit	CKS0 bit	SW3-4 (OCKS1)	SW3-5 (OCKS0)	Sampling Speed of AK4620B	MCLK Frequency of AK4620B
L	0	0	0	0	0	OFF	OFF	Normal Speed	256fs
L	0	0	0	0	1	ON	OFF	Normal Speed	512fs
L	0	1	0	0	1	OFF	OFF	Double Speed	256fs
L	1	0	0	0	1	ON	ON	Quad Speed	128fs

Table 14. Sampling Speed & Master clock Frequency in serial mode

* In serial mode, SW1-4(DFS0), SW1-6(CKS1) and S1-7(CSK0) should be always “OFF”, and DFS1, DFS0, CKS1, CKS0 and CMODE bits in the AK4620B should be set via the printer port (PORT3).

3-4) AK4114’s master clock mode & reference X’tal frequency

3-4-1) PLL is used as clock source

Synchronized signal should be set via PORT1(optical) or J6(BNC).

Mode	SW3-6 (CM1)	SW3-7 (CM0)	PLL	X’tal	Clock source	SDTO
0	OFF	OFF	ON	OFF	PLL	RX

Table 15. Clock Operation Mode (PLL)

SW3-1 (XTL1)	SW3-2 (XTL0)	X’tal Frequency
1	1	OFF

Table 16. Reference X’tal frequency(PLL)

3-4-2) X’tal is used as clock source

Mode	SW3-6 (CM1)	SW3-7 (CM0)	PLL	X’tal	Clock source	SDTO
1	OFF	ON	OFF	ON	X’tal	DAUX

Table 17. Clock Operation Mode (X’tal)

SW3-1 (XTL1)	SW3-2 (XTL0)	X’tal Frequency
1	0	24.576MHz

Table 18. Reference X’tal frequency (X’tal)

■ Set-up of SW1 and SW3

1) Set-up of SW1(AK4620B's mode set-up)

1-1) Audio data format in parallel mode

Mode	DIF (SW1-5)	SDTO	SDTI	LRCK	BICK	
2	OFF	24bit MSB Justified	24bit MSB Justified	H/L	≥48fs	(Default)
3	ON	I ² S Compatible	I ² S Compatible	L/H	≥48fs	

Table 19. Audio data format (parallel Mode)

1-2) De-emphasis control in parallel mode

DEM0 pin (SW1-3)	MODE	
OFF	ON(44.1KHz)	(Default)
ON	OFF	

Table 20. De-emphasis control (parallel mode)

1-3) parallel mode/ serial mode

P/S pin (SW1-1)	MODE	
OFF	Serial	(Default)
ON	Parallel	

Table 21. Set up P/S pin

2) Set-up of SW3(AK4114's mode set-up)

2-1) Audio data format

Mode	DIF0 (SW3-5)	SDTO	SDTI	LRCK	BICK	
4	L	24bit MSB Justified	24bit MSB Justified	H/L	≥48fs	(Default)
5	H	I ² S Compatible	I ² S Compatible	L/H	≥48fs	

Table22. Audio data format

* DIF1=L and DIF2=H are fixed in AKD4620B-B evaluation board.

■ The function of the toggle SW.

[SW2] : Resets the AK4620B. Keep “H” during normal operation.

■ Serial control mode

The AK4620B can be controlled via the printer port (parallel port) of IBM-AT compatible PC. Connect PORT3(CR-I/F) with PC by 10-wire flat cable packed with the AKD4620B-B.

Take care of the direction of connector. There is a mark at pin#1.

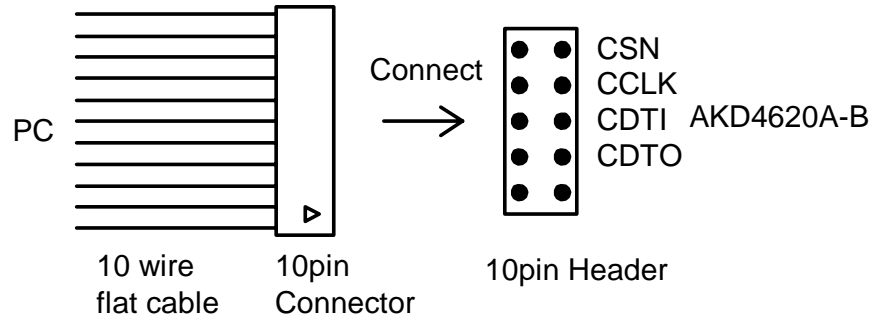

Figure 2. Connect of 10 wire flat cable

■ Analog Input Buffer Circuit

1. Differential Input Mode

The AK4620B can accept input voltages from AGND to VA. The input signal range scales with the VREF voltage and is nominally 2.82Vpp (VREF = 5V). Figure 3 shows an input buffer circuit example. This is a fully differential input buffer circuit with an inverted amplifier (fc=370KHz, gain: -10dB).

The capacitor of 10nF between AINL+/- (AINR+/-) decreases the clock feedthrough noise of the modulator, and composes a 1st order LPF (fc=360kHz) with a 22Ω resistor before the capacitor.

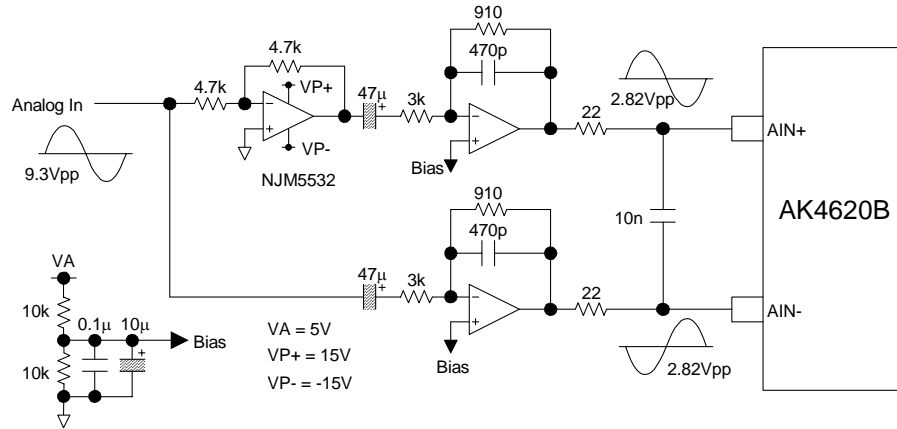

Figure 3. Input buffer circuit in differential mode

2. Single-ended Input Mode

When the AK4620B is evaluated by single-ended mode, C49 and C90 should be removed.

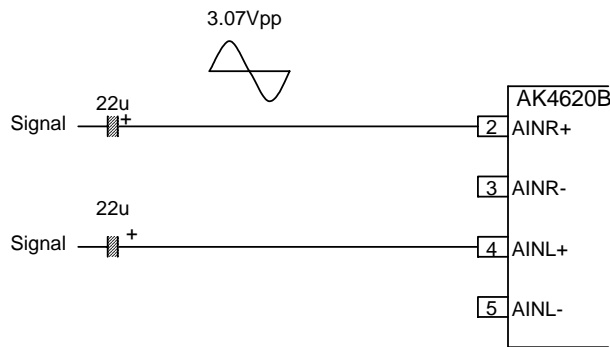

Figure 4. Input buffer circuit in Single-ended mode

■ Analog Output Buffer Circuit

The differential output circuit(2nd order LPF, $f_c=182\text{KHz}$, $Q=0.637$, $G=+3.9\text{dB}$) and LPF(1st order LPF, $f_c=284\text{KHz}$, $G=-0.84\text{dB}$) is implemented on board. The differential outputs of AK4620B is buffered by non-inverted circuit and output via Cannon connector (differential output). LPF adds differential outputs. NJM5534D is used for op-amp on this board that has low noise and high voltage tolerance characteristics. Analog signal is output via BNC connectors on the board. The output level is about 2.8Vrms (typ@ $V_{REF}=5.0\text{V}$) by BNC.

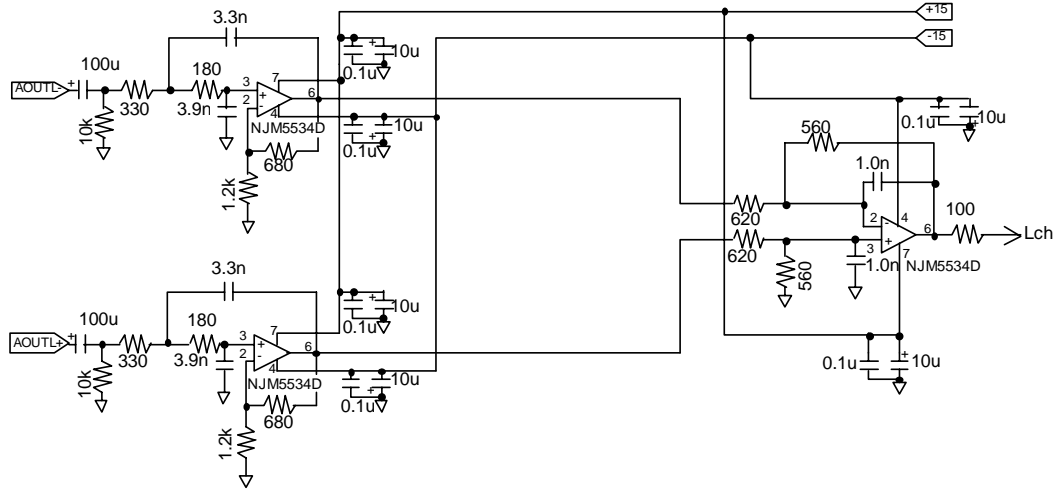

Figure 5. Output buffer circuit

* AKM assumes no responsibility for the trouble when using the above circuit examples.

Control Software Manual

■ Set-up of evaluation board and control software

1. Set up the AKD4620B-B according to previous term.
2. Connect IBM-AT compatible PC with AKD4620B-B by 10-line type flat cable (packed with AKD4620B-B). Take care of the direction of 10pin header. (Please install the driver in the CD-ROM when this control software is used on Windows 2000/XP. Please refer “Installation Manual of Control Software Driver by AKM device control software”. In case of Windows95/98/ME, this installation is not needed. This control software does not operate on Windows NT.)
3. Insert the CD-ROM labeled “AKD4620B-B Evaluation Kit” into the CD-ROM drive.
4. Access the CD-ROM drive and double-click the icon of “akd4620b-b.exe” to set up the control program.
5. Then please evaluate according to the follows.

■ Operation flow

Keep the following flow.

1. Set up the control program according to explanation above.
2. Click “Port Reset” button.
3. Click “Write default” button

■ Explanation of each buttons

[Port Reset] :	Set up the USB interface board (AKDUSBIF-A) .
[Write default] :	Initialize the register of AK4620B.
[All Write] :	Write all registers that is currently displayed.
[Function1] :	Dialog to write data by keyboard operation.
[Function2] :	Dialog to write data by keyboard operation.
[Function3] :	The sequence of register setting can be set and executed.
[Function4] :	The sequence that is created on [Function3] can be assigned to buttons and executed.
[Function5] :	The register setting that is created by [SAVE] function on main window can be assigned to buttons and executed.
[SAVE] :	Save the current register setting.
[OPEN] :	Write the saved values to all register.
[Write] :	Dialog to write data by mouse operation.

■ Indication of data

Input data is indicated on the register map. Red letter indicates “H” or “1” and blue one indicates “L” or “0”. Blank is the part that is not defined in the datasheet.

■ Explanation of each dialog

1. [Write Dialog]: Dialog to write data by mouse operation

There are dialogs corresponding to each register.

Click the [Write] button corresponding to each register to set up the dialog. If you check the check box, data becomes “H” or “1”. If not, “L” or “0”.

If you want to write the input data to the AK4620B, click [OK] button. If not, click [Cancel] button.

2. [Function1 Dialog]: Dialog to write data by keyboard operation

Address Box: Input registers address in 2 figures of hexadecimal.

Data Box: Input registers data in 2 figures of hexadecimal.

If you want to write the input data to the AK4620B, click [OK] button. If not, click [Cancel] button.

3. [Function2 Dialog]: Dialog to evaluate volume

Address Box: Input registers address in 2 figures of hexadecimal.

Start Data Box: Input starts data in 2 figures of hexadecimal.

End Data Box: Input end data in 2 figures of hexadecimal.

Interval Box: Data is written to the AK4620B by this interval.

Step Box: Data changes by this step.

Mode Select Box:

If you check this check box, data reaches end data, and returns to start data.

[Example] Start Data = 00, End Data = 09

Data flow: 00 01 02 03 04 05 06 07 08 09 09 08 07 06 05 04 03 02 01 00

If you do not check this check box, data reaches end data, but does not return to start data.

[Example] Start Data = 00, End Data = 09

Data flow: 00 01 02 03 04 05 06 07 08 09

If you want to write the input data to the AK4620B, click [OK] button. If not, click [Cancel] button.

4. [SAVE] and [OPEN]

4-1. [SAVE]

All of current register setting values displayed on the main window are saved to the file. The extension of file name is “.akr”.

<Operation flow>

- (1) Click [SAVE] Button.
- (2) Set the file name and click [SAVE] Button. The extension of file name is “.akr”.

4-2. [OPEN]

The register setting values saved by [SAVE] are written to the AK4620B. The file type is the same as [SAVE].

<Operation flow>

- (1) Click [OPEN] Button.
- (2) Select the file (*.akr) and Click [OPEN] Button.

5. [Function3 Dialog]

The sequence of register setting can be set and executed.

- (1) Click [F3] Button.
- (2) Set the control sequence.
Set the address, Data and Interval time. Set “-1” to the address of the step where the sequence should be paused.
- (3) Click [START] button. Then this sequence is executed.

The sequence is paused at the step of Interval="-1". Click [START] button, the sequence restarts from the paused step.

This sequence can be saved and opened by [SAVE] and [OPEN] button on the Function3 window. The extension of file name is “aks”.

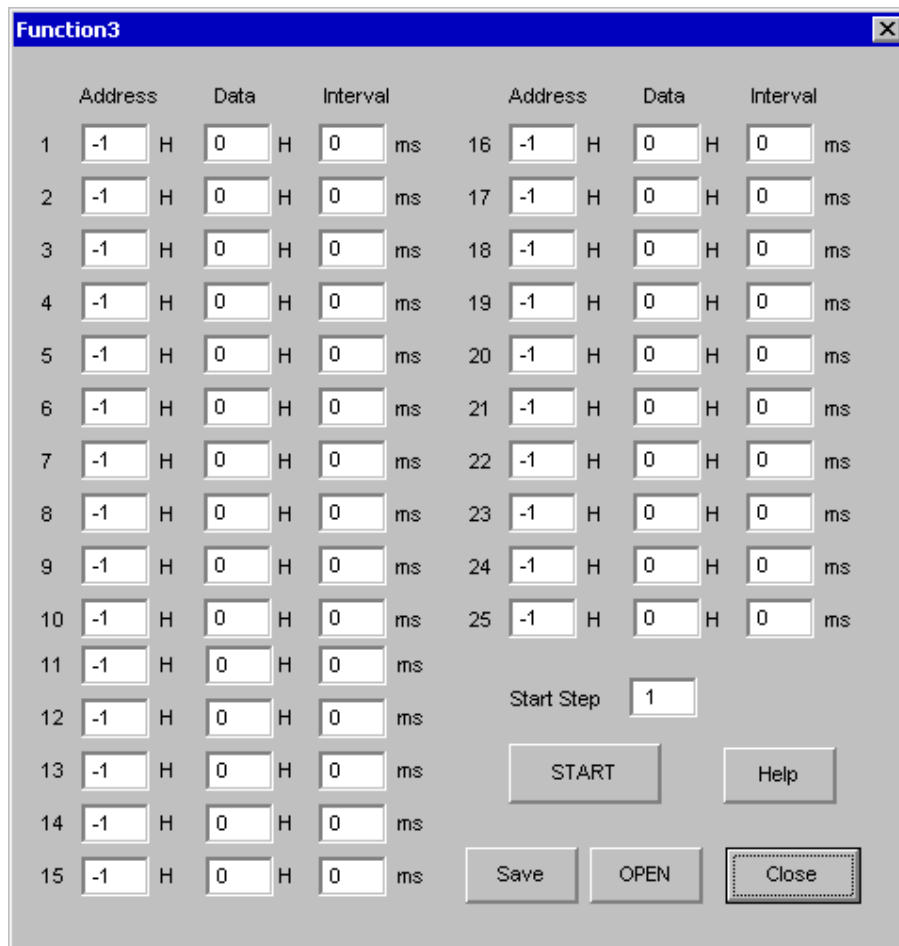

Figure 6. Window of [F3]

6. [Function4 Dialog]

The sequence file (*.aks) saved by [Function3] can be listed up to 10 files, assigned to buttons and then executed. When [F4] button is clicked, the window as shown in Figure 10 opens.

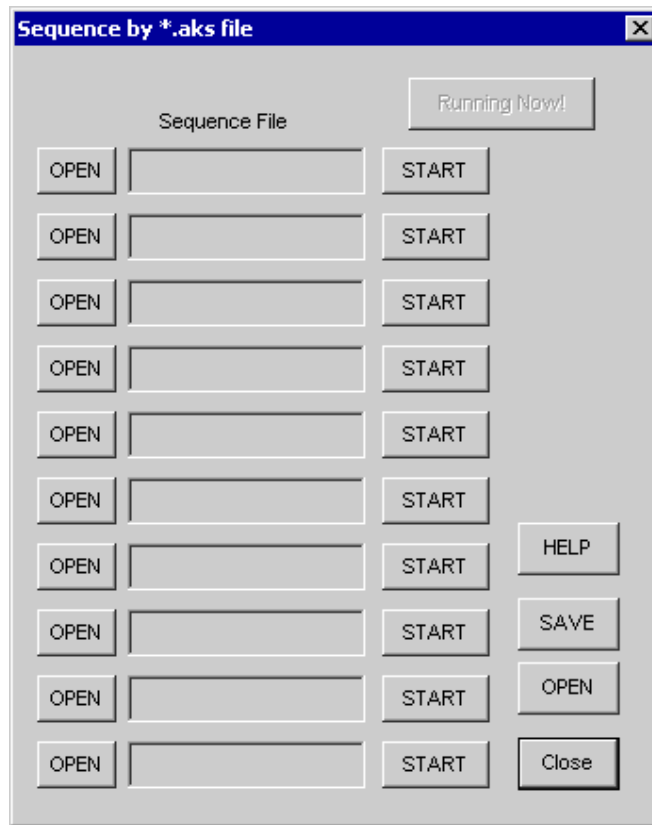

Figure 7. [F4] window

6-1. [OPEN] buttons on left side and [START] buttons

(1) Click [OPEN] button and select the sequence file (*.aks) saved by [Function3].

The sequence file name is displayed as shown in Figure 11. (In case that the selected sequence file name is "DAC_Stereo_ON.aks")

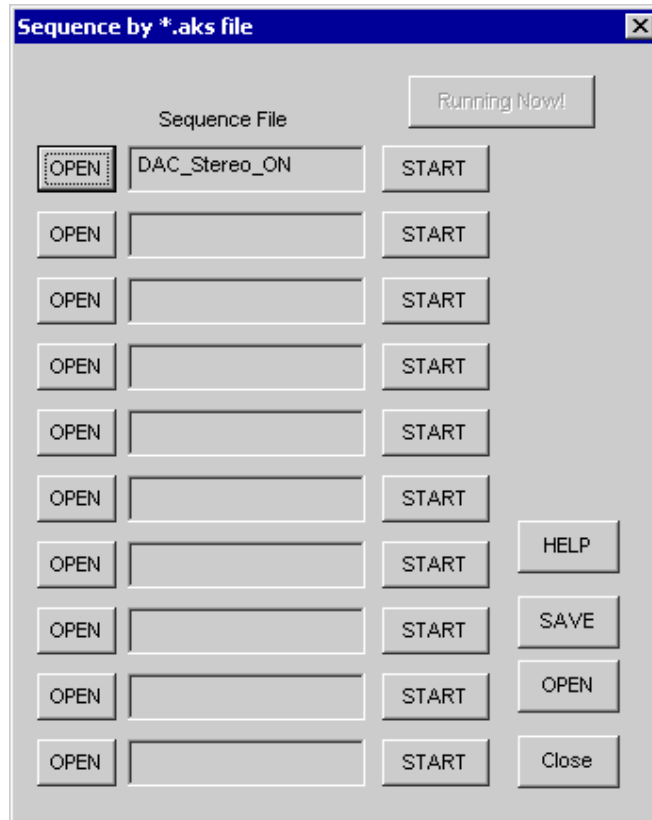

Figure 8. [F4] window(2)

(2) Click [START] button, then the sequence is executed.

6-2. [SAVE] and [OPEN] buttons on right side

[SAVE] : The name assign of sequence file displayed on [Function4] window can be saved to the file. The file name is "*.ak4".

[OPEN] : The name assign of sequence file(*.ak4) saved by [SAVE] is loaded.

6-3. Note

(1) This function doesn't support the pause function of sequence function.

(2) All files used by [SAVE] and [OPEN] function on right side need to be in the same folder.

(3) When the sequence is changed in [Function3], the sequence file (*.aks) should be loaded again in order to reflect the change.

7. [Function5 Dialog]

The register setting file(*.akr) saved by [SAVE] function on main window can be listed up to 10 files, assigned to buttons and then executed. When [F5] button is clicked, the window as shown in Figure 12 opens.

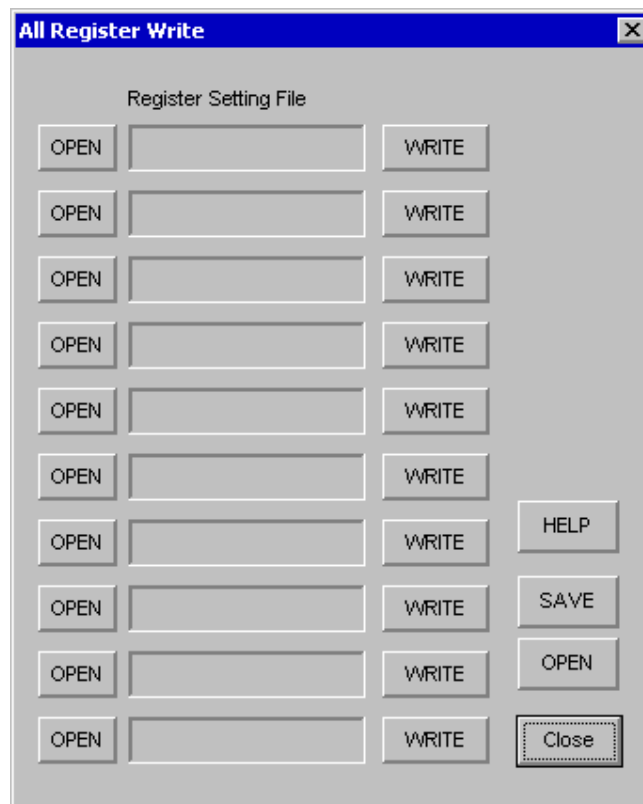

Figure 9. [F5] window

7-1. [OPEN] buttons on left side and [WRITE] button

(1) Click [OPEN] button and select the register setting file (*.akr).

The register setting file name is displayed as shown in Figure 13. (In case that the selected file name is "DAC_Output.akr")

(2) Click [WRITE] button, then the register setting is executed.

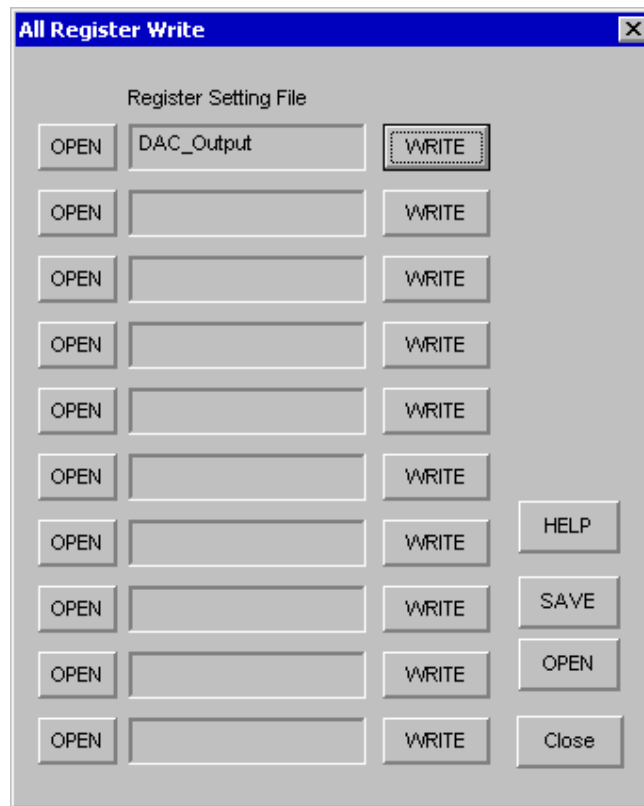

Figure 10. [F5] windows(2)

7-2. [SAVE] and [OPEN] buttons on right side

[SAVE] : The name assign of register setting file displayed on [Function5] window can be saved to the file. The file name is “*.ak5”.

[OPEN] : The name assign of register setting file(*.ak5) saved by [SAVE] is loaded.

7-3. Note

- (1) All files used by [SAVE] and [OPEN] function on right side need to be in the same folder.
- (2) When the register setting is changed by [SAVE] Button on the main window, the register setting file (*.akr) should be loaded again in order to reflect the change.

MEASUREMENT RESULTS

[Measurement condition]

Measurement unit: Audio Precision System Two Cascade

MCLK: 512fs (44.1kHz), 256fs (96kHz), 128fs (192kHz)

BICK: 64fs

Power supply Voltage: VA=VT=5.0V, VD=3.3V

Interface: Internal DIT or DIR (44.1kHz, 96kHz, 192kHz)

Temperature: Room Temp.

1. ADC (Single-ended)

fs=44.1kHz

Parameter	Input signal	Measurement filter	Results	
			L ch	R ch
S/(N+D)	1kHz, -1dB	20kLPF	89.7dB	90.0dB
DR	1kHz, -60dB	20kLPF	108.2dB	108.2dB
DR	1kHz, -60dB	20kLPF, A-weighted	110.9dB	110.9dB
S/N	No input	20kLPF, A-weighted	110.9dB	110.9dB

fs=96kHz

Parameter	Input signal	Measurement filter	Results	
			L ch	R ch
S/(N+D)	1kHz, -1dB	40kLPF	89.2dB	89.5dB
DR	1kHz, -60dB	40kLPF	104.8dB	104.7dB
DR	1kHz, -60dB	40kLPF, A-weighted	110.7dB	110.7dB
S/N	No input	40kLPF, A-weighted	110.7dB	110.7dB

fs=192kHz

Parameter	Input signal	Measurement filter	Results	
			L ch	R ch
S/(N+D)	1kHz, -1dB	40kLPF	89.0dB	89.3dB
DR	1kHz, -60dB	40kLPF	104.8dB	104.8dB
DR	1kHz, -60dB	40kLPF, A-weighted	110.6dB	110.6dB
S/N	No input	40kLPF, A-weighted	110.5dB	110.5dB

2. ADC (Differential)

fs=44.1kHz

Parameter	Input signal	Measurement filter	Results	
			L ch	R ch
S/(N+D)	1kHz, -1dB	20kLPF	100.7dB	101.5dB
DR	1kHz, -60dB	20kLPF	111.8dB	111.8dB
DR	1kHz, -60dB	20kLPF, A-weighted	114.5dB	114.4dB
S/N	No input	20kLPF, A-weighted	114.5dB	114.4dB

fs=96kHz

Parameter	Input signal	Measurement filter	Results	
			L ch	R ch
S/(N+D)	1kHz, -1dB	40kLPF	101.0dB	101.5dB
DR	1kHz, -60dB	40kLPF	107.6dB	107.6dB
DR	1kHz, -60dB	40kLPF, A-weighted	114.3dB	114.2dB
S/N	No input	40kLPF, A-weighted	114.3dB	114.2dB

fs=192kHz

Parameter	Input signal	Measurement filter	Results	
			L ch	R ch
S/(N+D)	1kHz, -1dB	40kLPF	100.8dB	101.4dB
DR	1kHz, -60dB	40kLPF	107.5dB	107.4dB
DR	1kHz, -60dB	40kLPF, A-weighted	113.8dB	114.0dB
S/N	No input	40kLPF, A-weighted	113.8dB	114.0dB

3. DAC

fs=44.1kHz

Parameter	Input signal	Measurement filter	Results	
			L ch	R ch
S/(N+D)	1kHz, 0dB	20kLPF	99.8dB	96.7dB
DR	1kHz, -60dB	20kLPF	113.0dB	113.0dB
DR	1kHz, -60dB	22kLPF, A-weighted	115.2dB	115.2dB
S/N	"0" data	22kLPF, A-weighted	115.3dB	115.3dB

fs=96kHz

Parameter	Input signal	Measurement filter	Results	
			L ch	R ch
S/(N+D)	1kHz, 0dB	40kLPF	99.3dB	96.8dB
DR	1kHz, -60dB	40kLPF	110.3dB	110.4dB
DR	1kHz, -60dB	40kLPF, A-weighted	115.3dB	115.3dB
S/N	"0" data	40kLPF, A-weighted	115.3dB	115.4dB

fs=192kHz

Parameter	Input signal	Measurement filter	Results	
			L ch	R ch
S/(N+D)	1kHz, 0dB	40kLPF	98.6dB	96.3dB
DR	1kHz, -60dB	40kLPF	110.0dB	110.0dB
DR	1kHz, -60dB	40kLPF, A-weighted	114.9dB	114.9dB
S/N	"0" data	40kLPF, A-weighted	115.3dB	115.3dB

[Plots]

ADC (Single-ended)

(fs=44.1kHz)

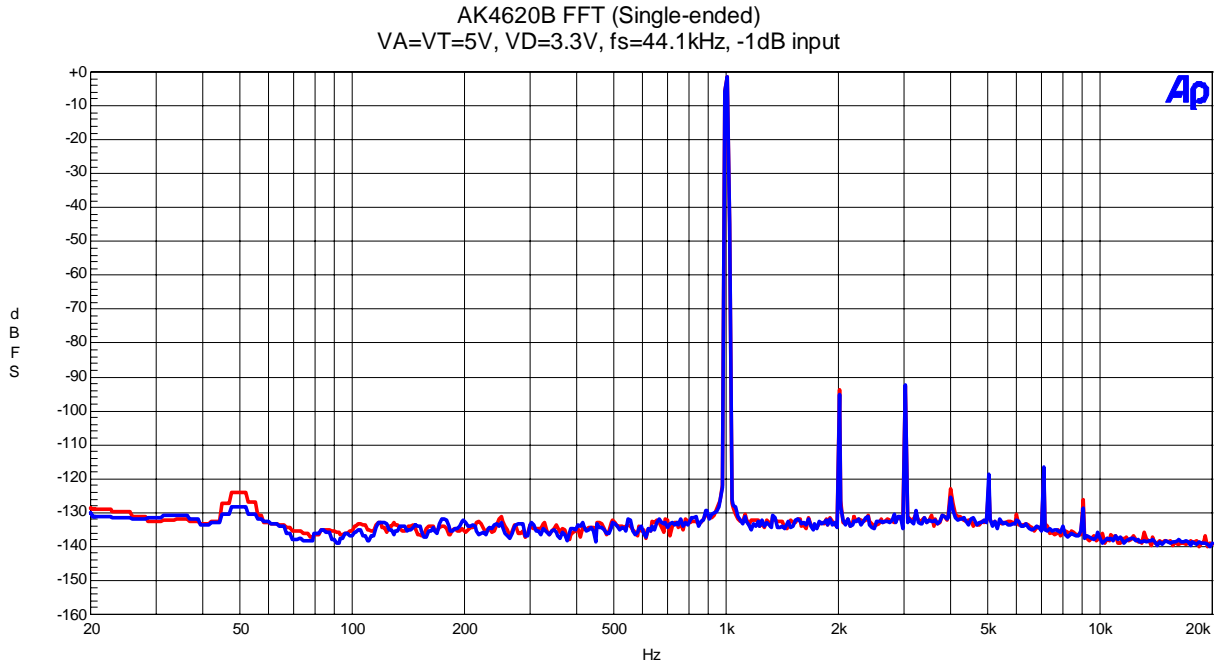

Figure 11. FFT (fin=1kHz, Input Level=-1dBFS)

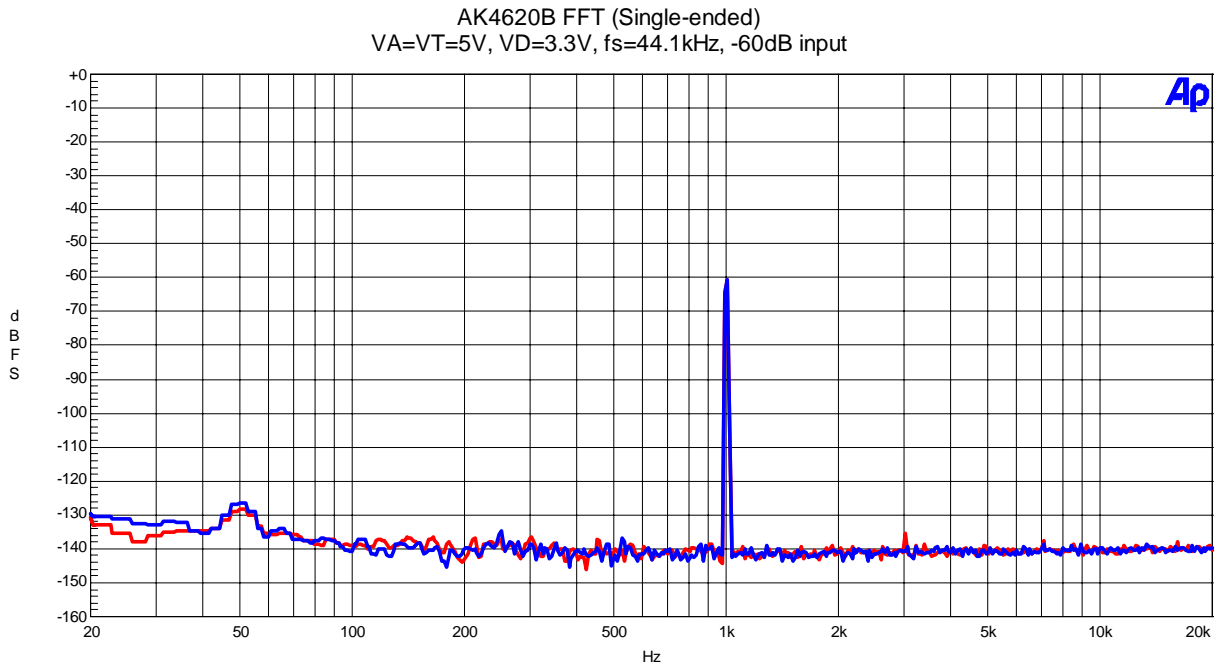

Figure 12. FFT (fin=1kHz, Input Level=-60dBFS)

(fs=44.1kHz)

AK4620B FFT (Single-ended)
VA=VT=5V, VD=3.3V, fs=44.1kHz, No input

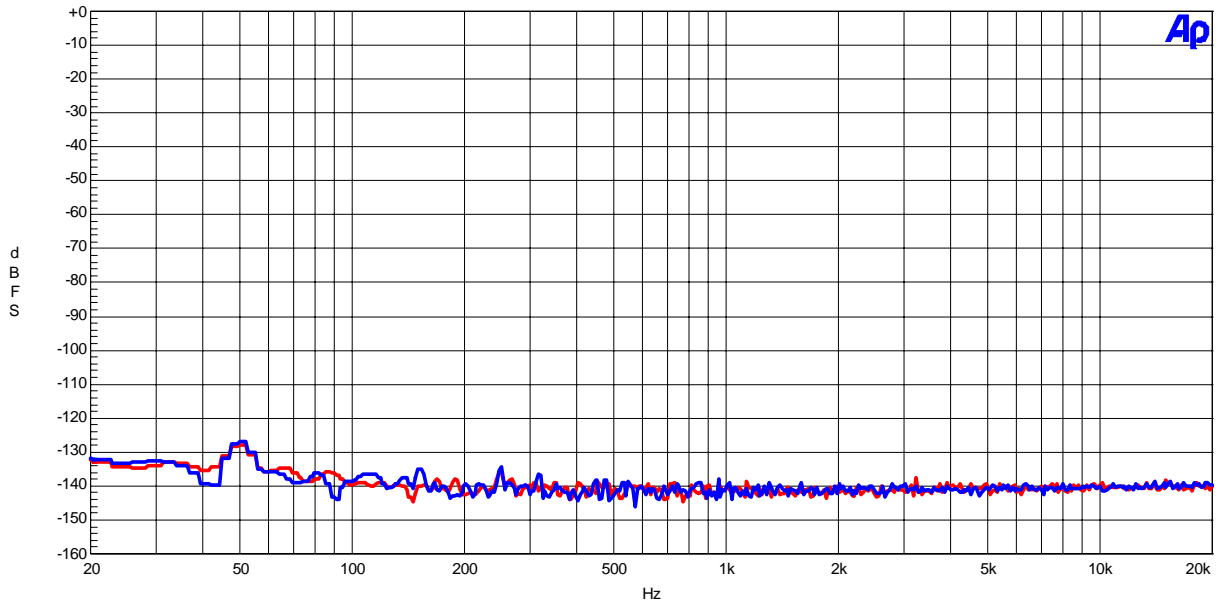

Figure 13. FFT (Noise Floor)

AK4620B THD+N vs Input Level
VA=VT=5V, VD=3.3V, fs=44.1kHz

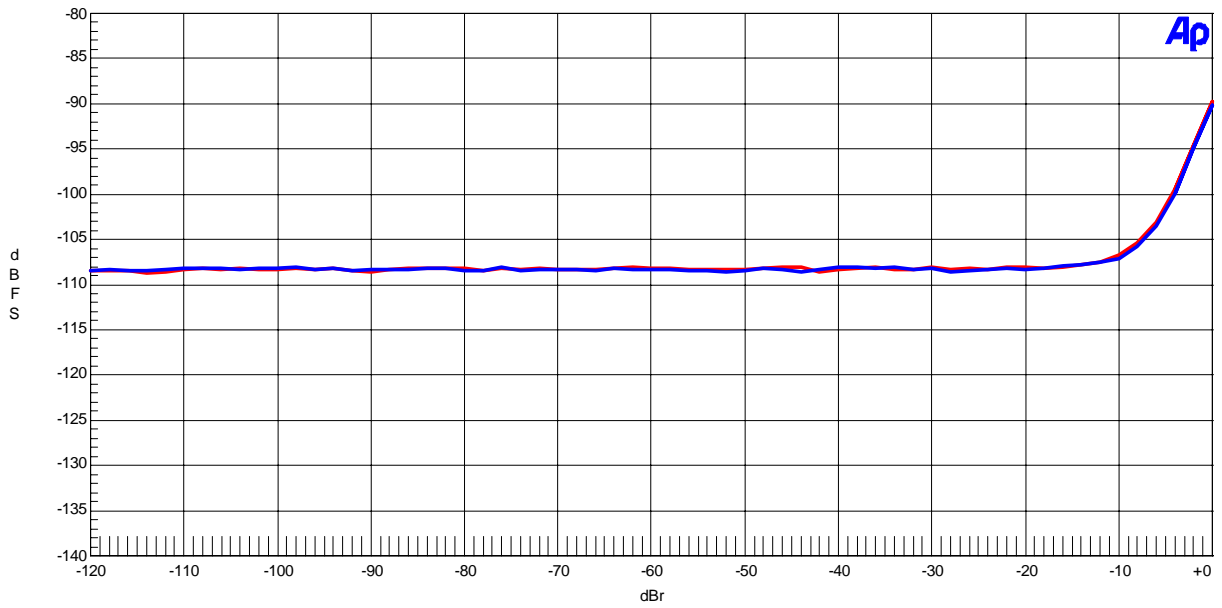

Figure 14. THD+N vs. Input level (fin=1kHz)

(fs=44.1kHz)

AK4620B THD+N vs Input Frequency
VA=VT=5V, VD=3.3V, fs=44.1kHz

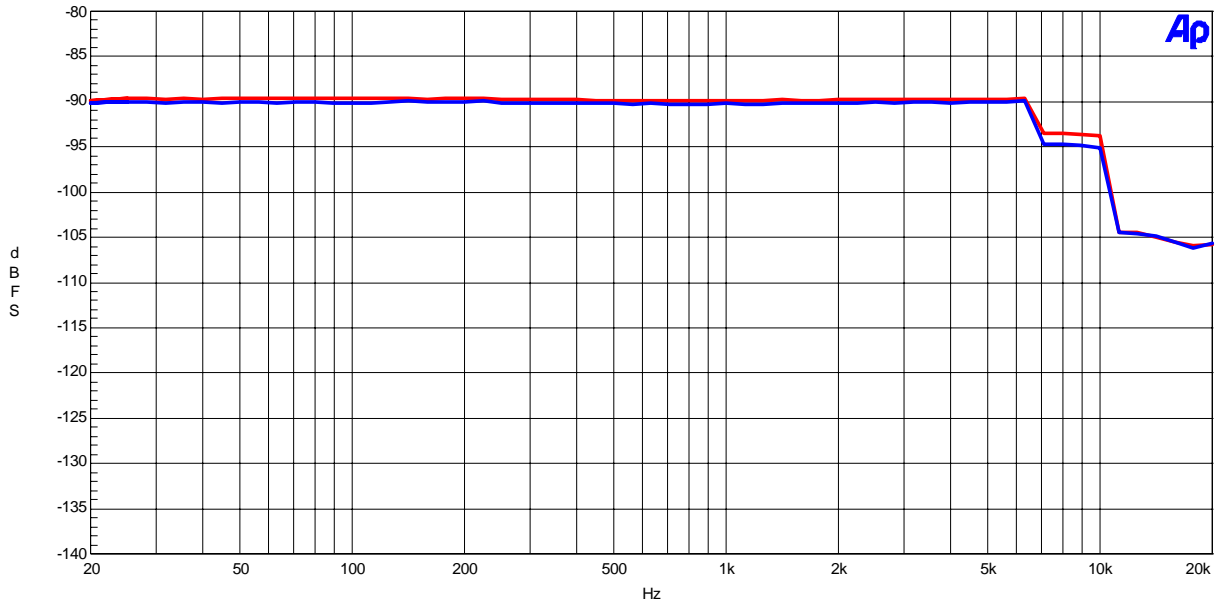

Figure 15. THD +N vs. Input Frequency (Input level=-1dBFS)

AK4620B Linearity
VA=VT=5V, VD=3.3V, fs=44.1kHz

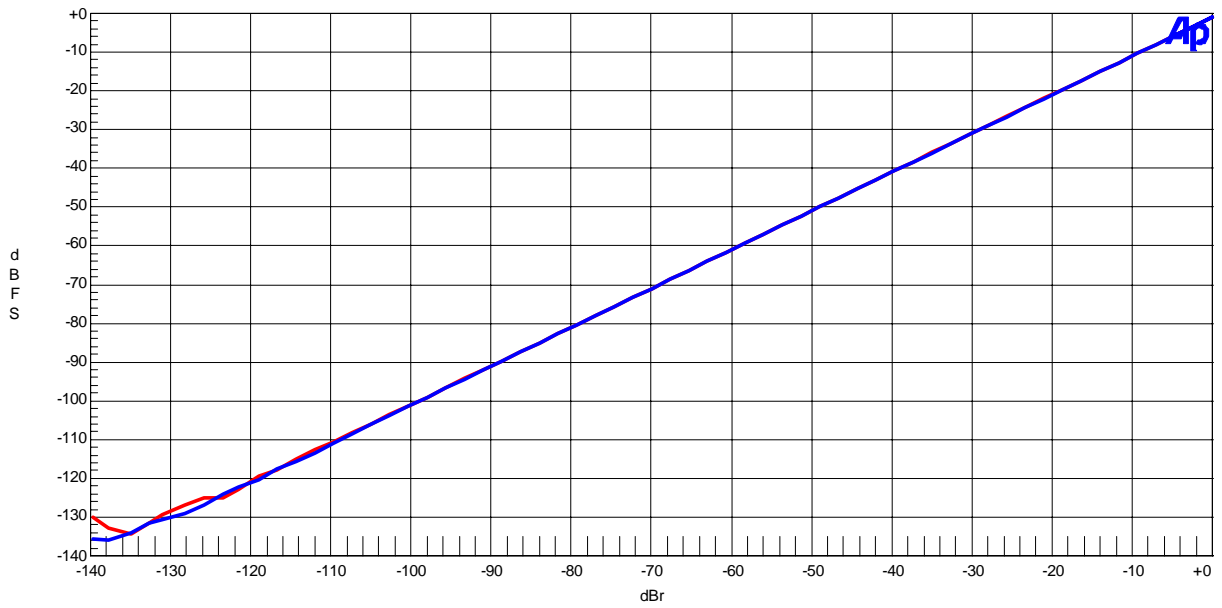

Figure 16. Linearity (fin=1kHz)

(fs=44.1kHz)

AK4620B Frequency Respons
VA=VT=5V, VD=3.3V, fs=44.1kHz

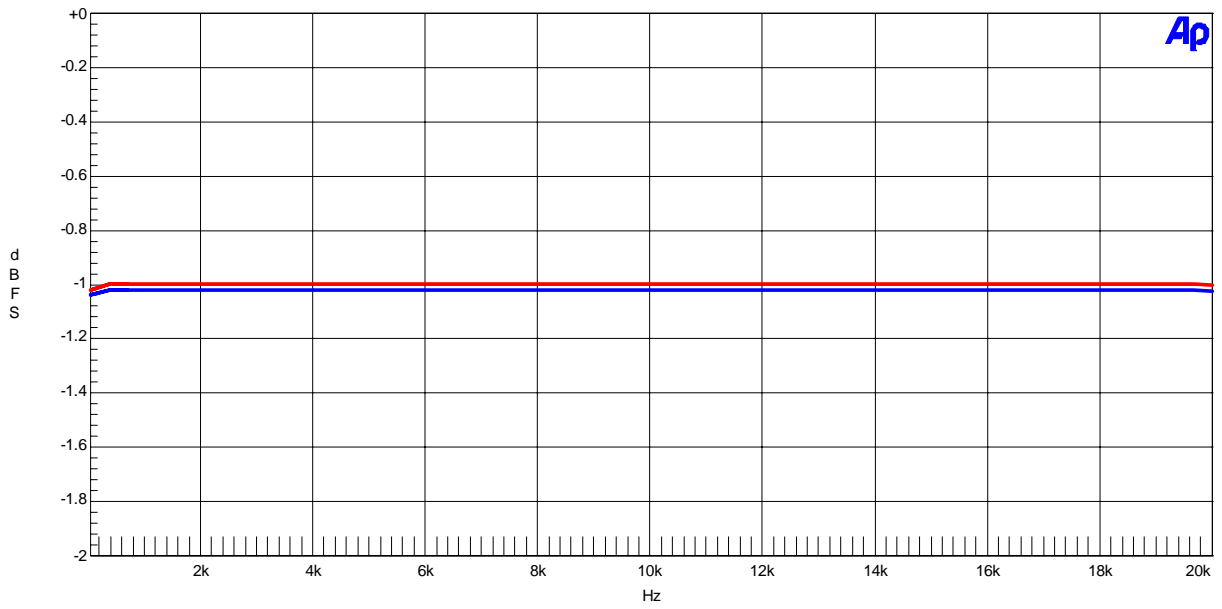

Figure 17. Frequency Response

AK4620B Crosstalk Lch: Red, Rch: Blue
VA=VT=5V, VD=3.3V, fs=44.1kHz

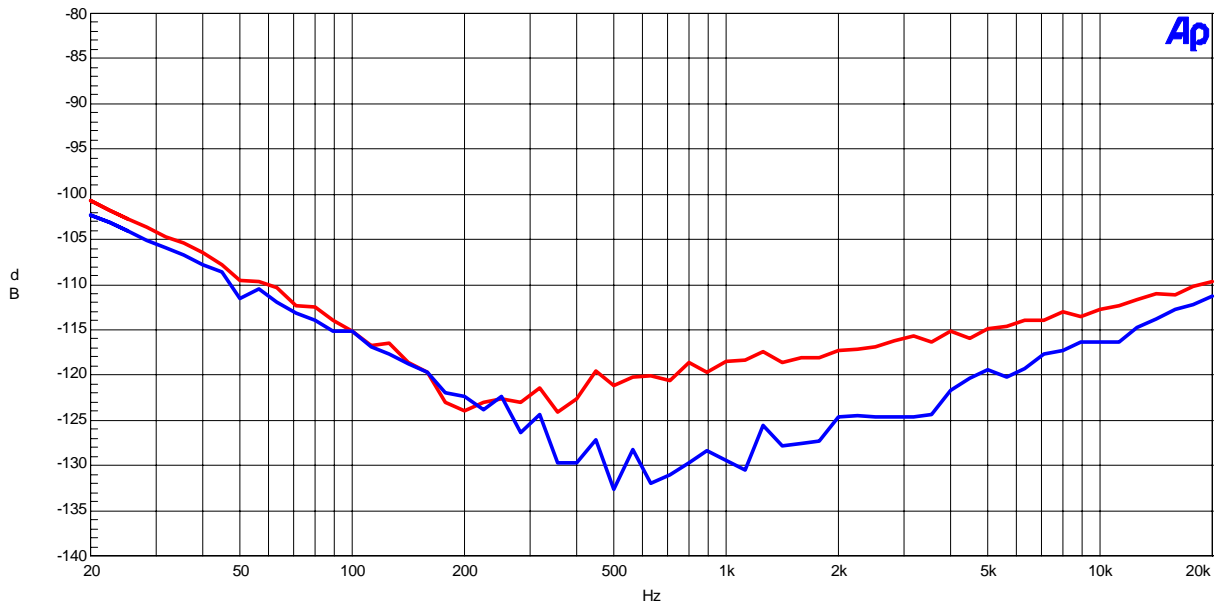

Figure 18. Crosstalk

(fs=96kHz)

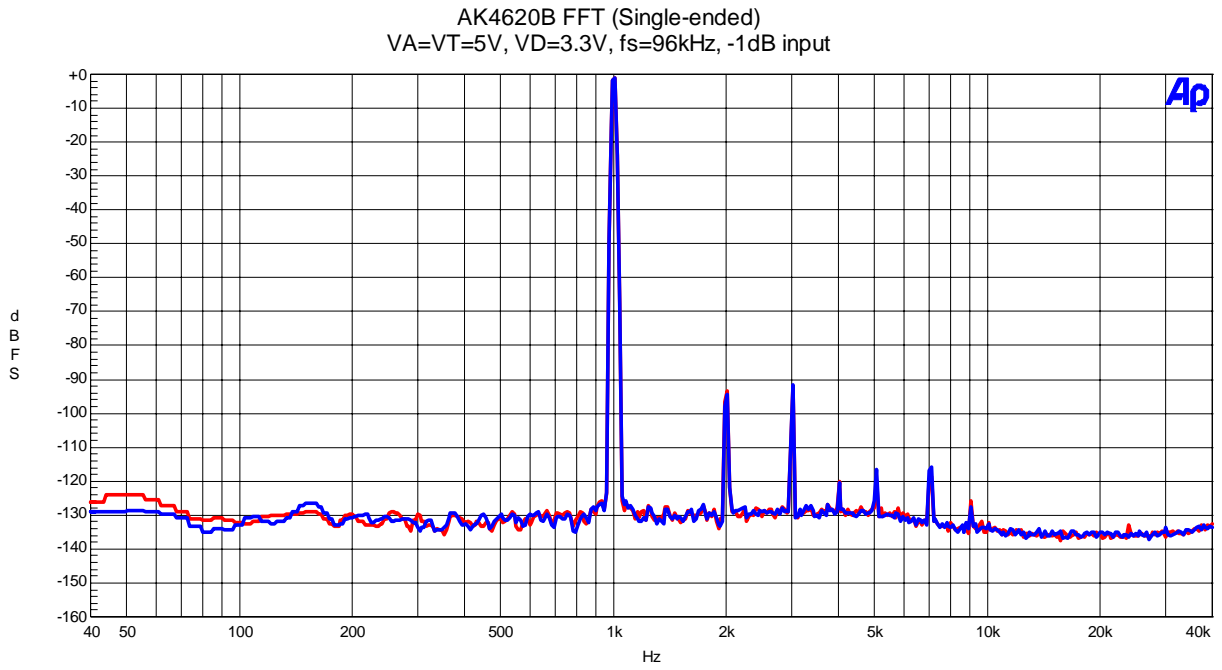

Figure 19. FFT (fin=1kHz, Input Level=-1dBFS)

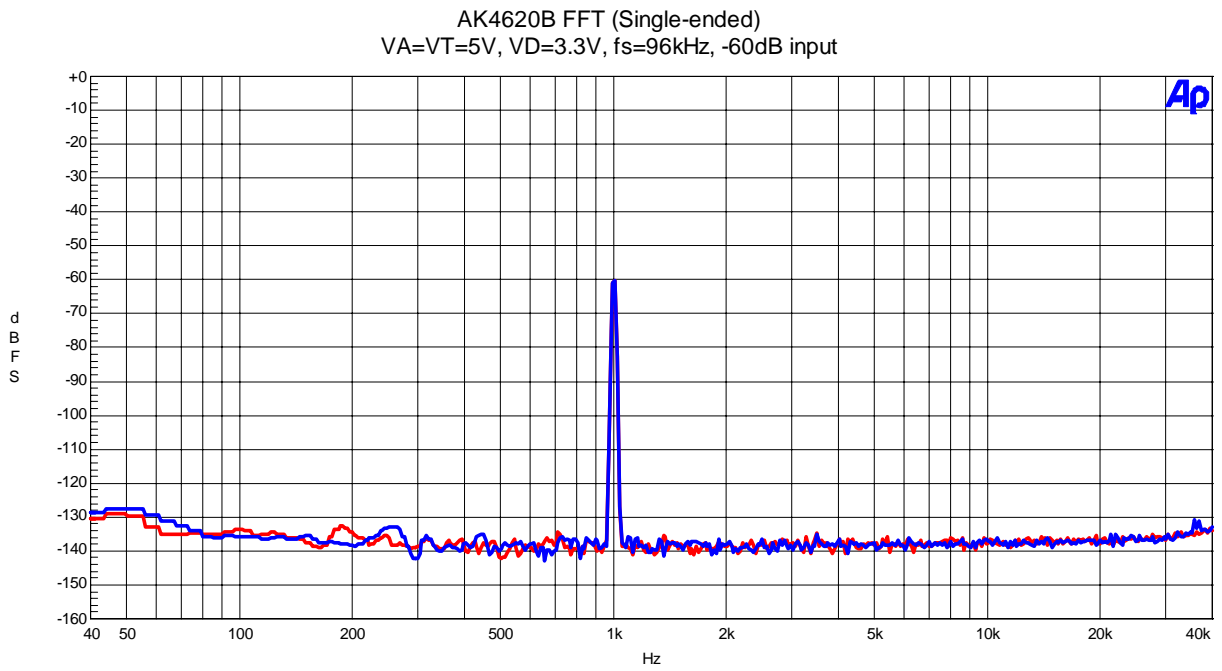

Figure 20. FFT (fin=1kHz, Input Level=-60dBFS)

(fs=96kHz)

AK4620B FFT (Single-ended)
VA=VT=5V, VD=3.3V, fs=96kHz, No input

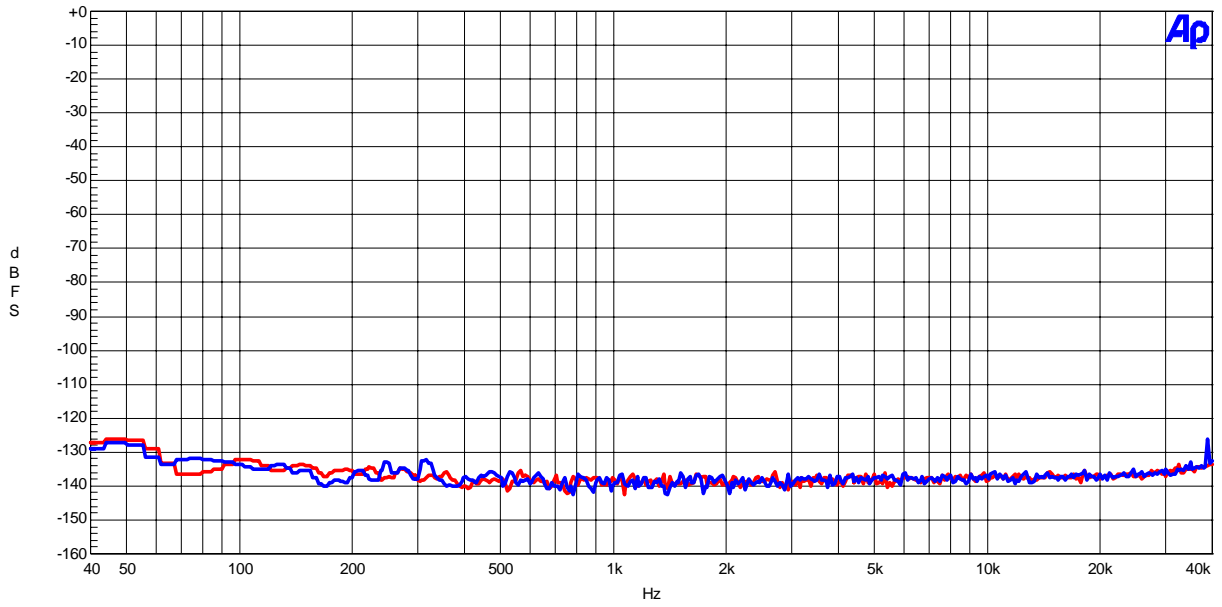

Figure 21. FFT (Noise Floor)

AK4620B THD+N vs Input Level
VA=VT=5V, VD=3.3V, fs=96kHz

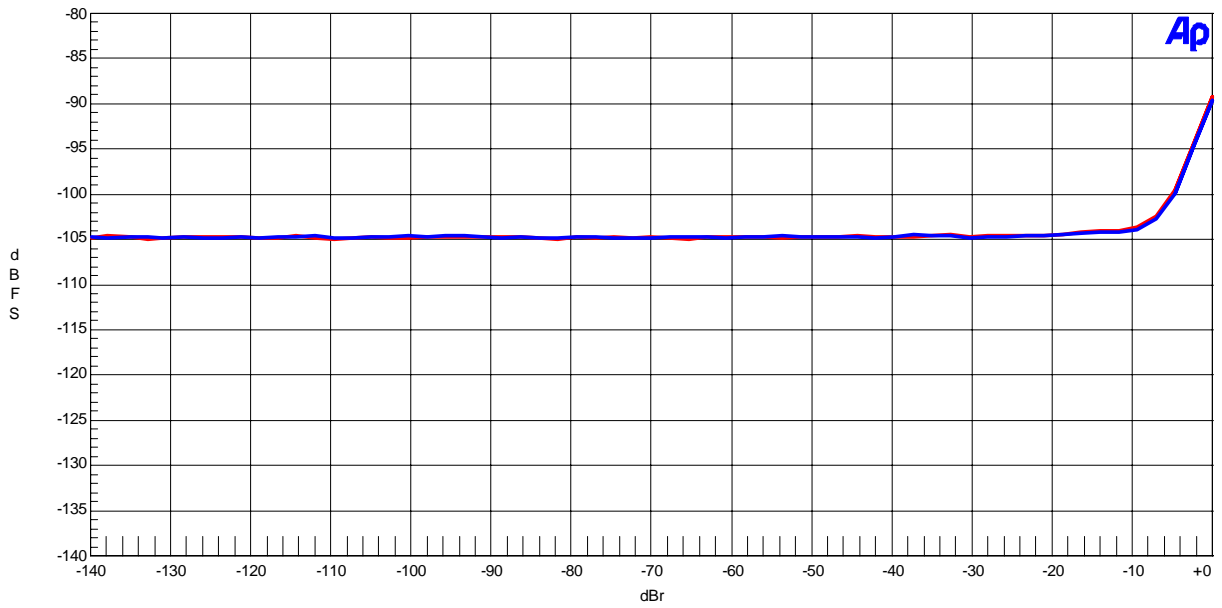

Figure 22. THD +N vs. Input level (fin=1kHz)

(fs=96kHz)

AK4620B THD+N vs Input Frequency
VA=VT=5V, VD=3.3V, fs=96kHz

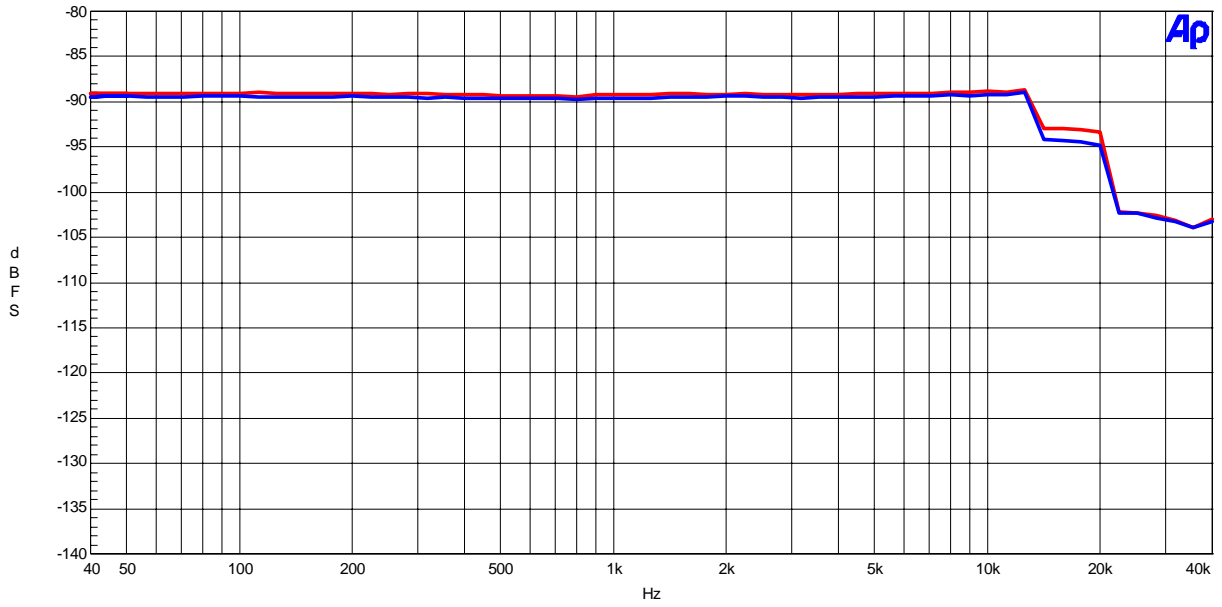

Figure 23. THD +N vs. Input Frequency (Input level=-1dBFS)

AK4620B Linearity
VA=VT=5V, VD=3.3V, fs=96kHz

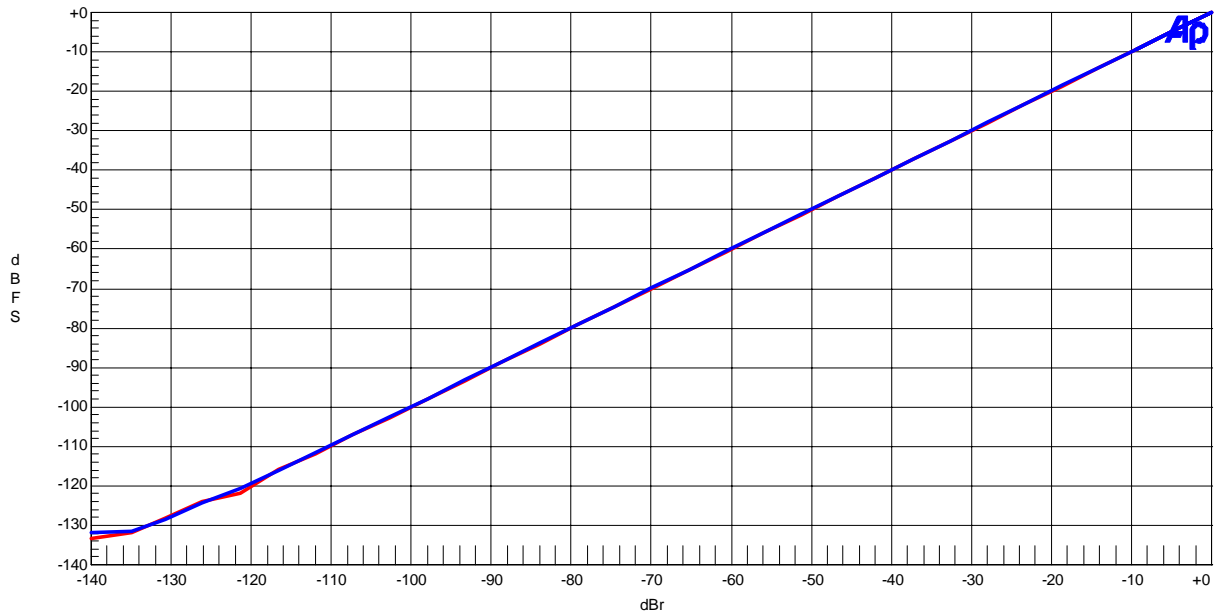

Figure 24. Linearity (fin=1kHz)

(fs=96kHz)

AK4620B Frequency Respons
VA=VT=5V, VD=3.3V, fs=96kHz

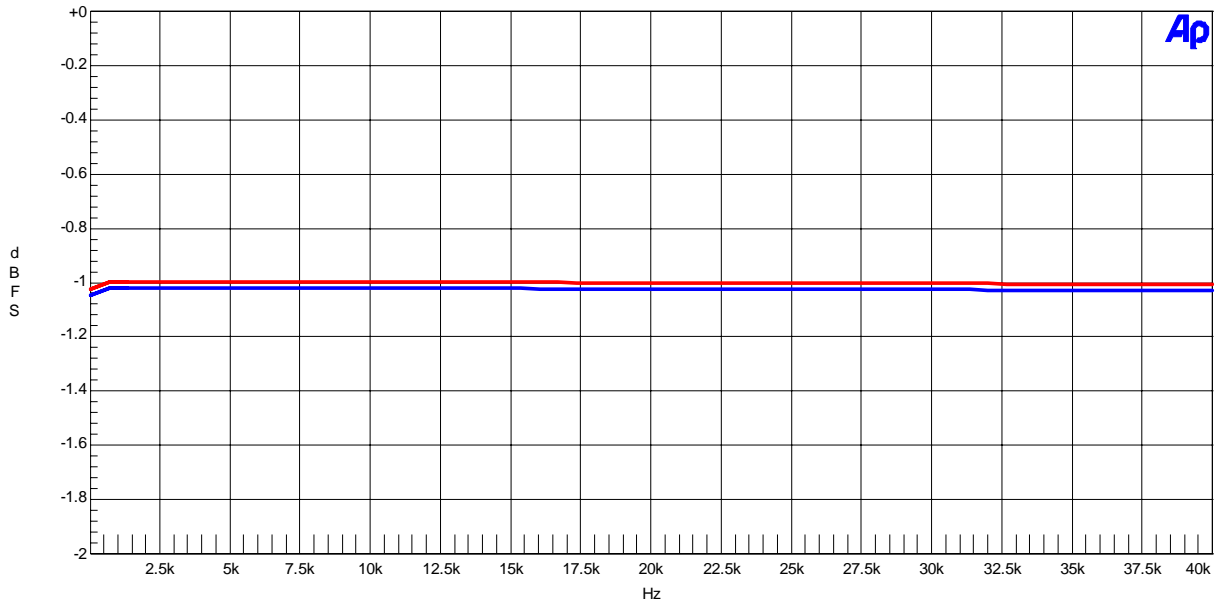

Figure 25. Frequency Response

AK4620B Crosstalk Lch: Red, Rch: Blue
VA=VT=5V, VD=3.3V, fs=96kHz

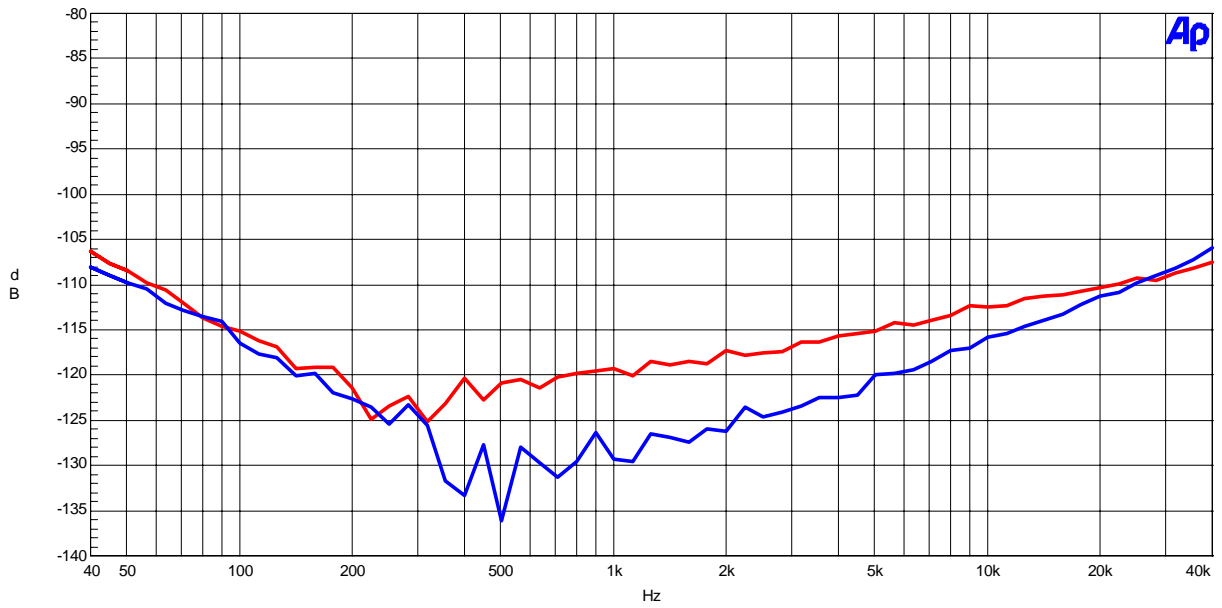

Figure 26. Crosstalk

(fs=192kHz)

AKM

AK4620 FFT (Singl-ended)
VA=VT=5V, VD=3.3V, fs=192kHz, -1dB input

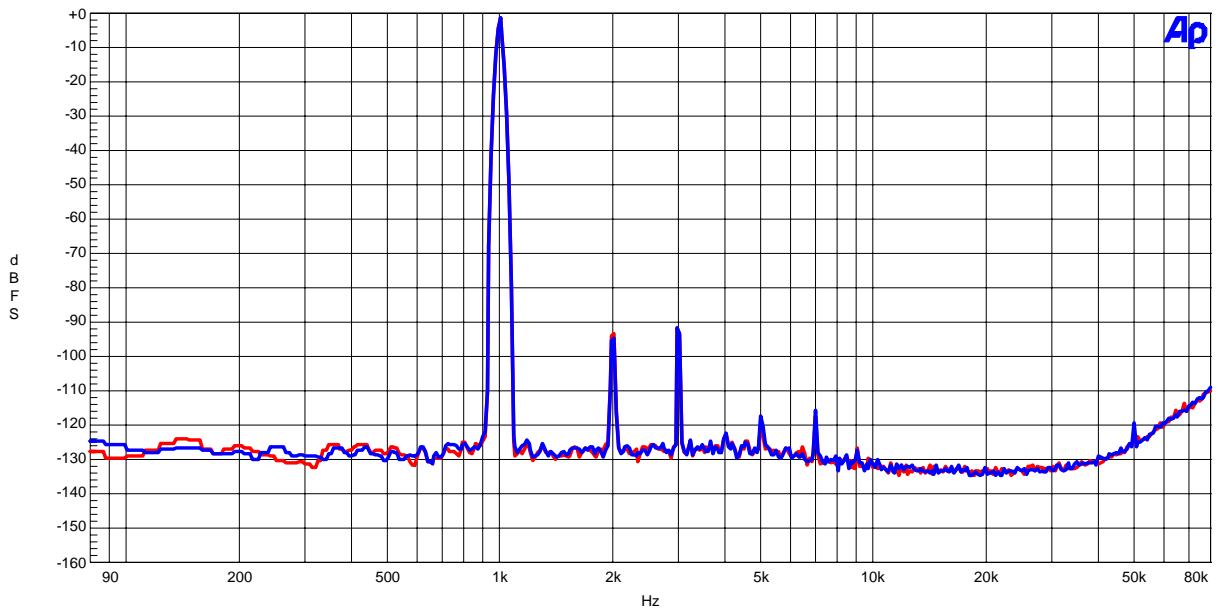

Figure 27. FFT (fin=1kHz, Input Level=-1dBFS)

AKM

AK4620 FFT (Singl-ended)
VA=VT=5V, VD=3.3V, fs=192kHz, -60dB input

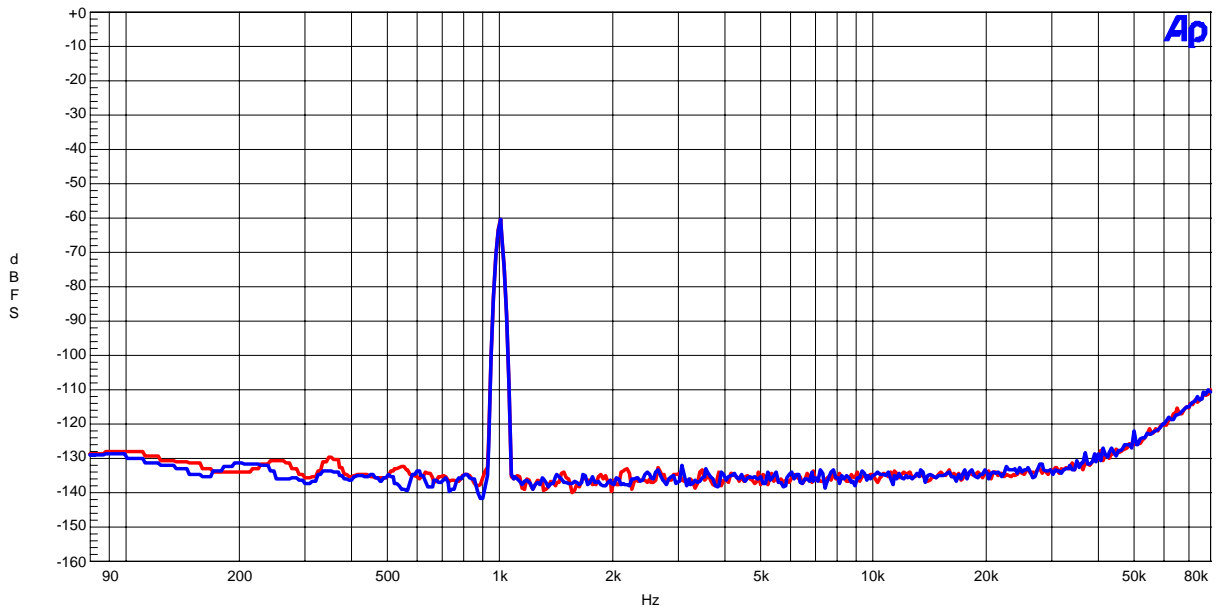

Figure 28. FFT (fin=1kHz, Input Level=-60dBFS)

(fs=192kHz)

AKM

AK4620 FFT (Singl-ended)
VA=VT=5V, VD=3.3V, fs=192kHz, No input

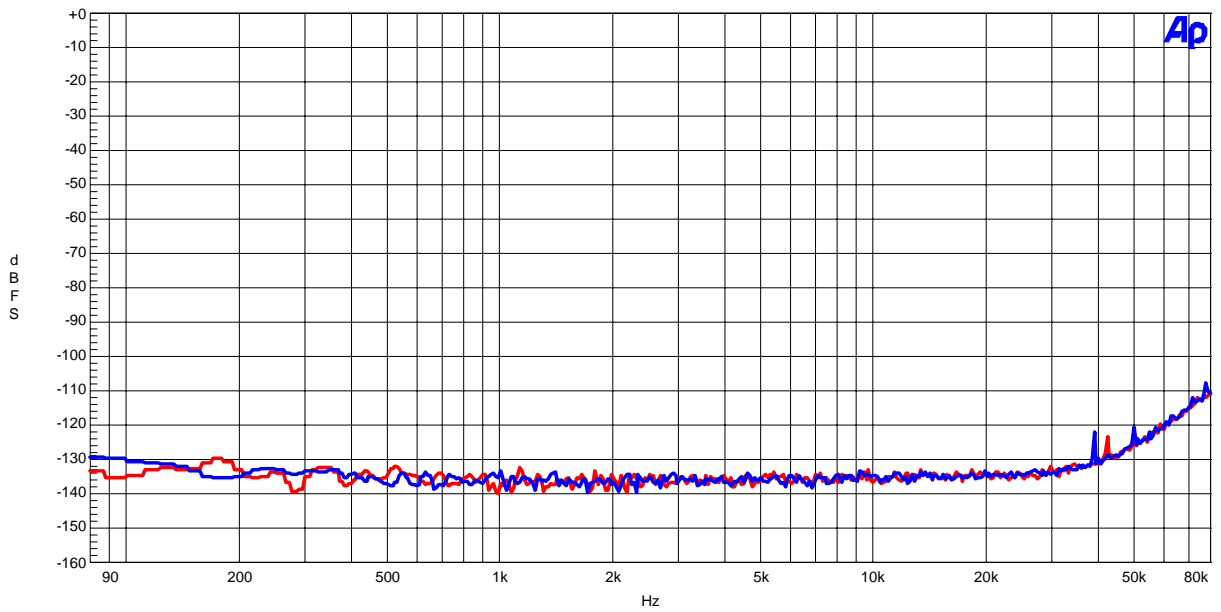

Figure 29. FFT (Noise Floor)

AKM

AK4620 THD+N vs Input Level
VA=VT=5V, VD=3.3V, fs=192kHz

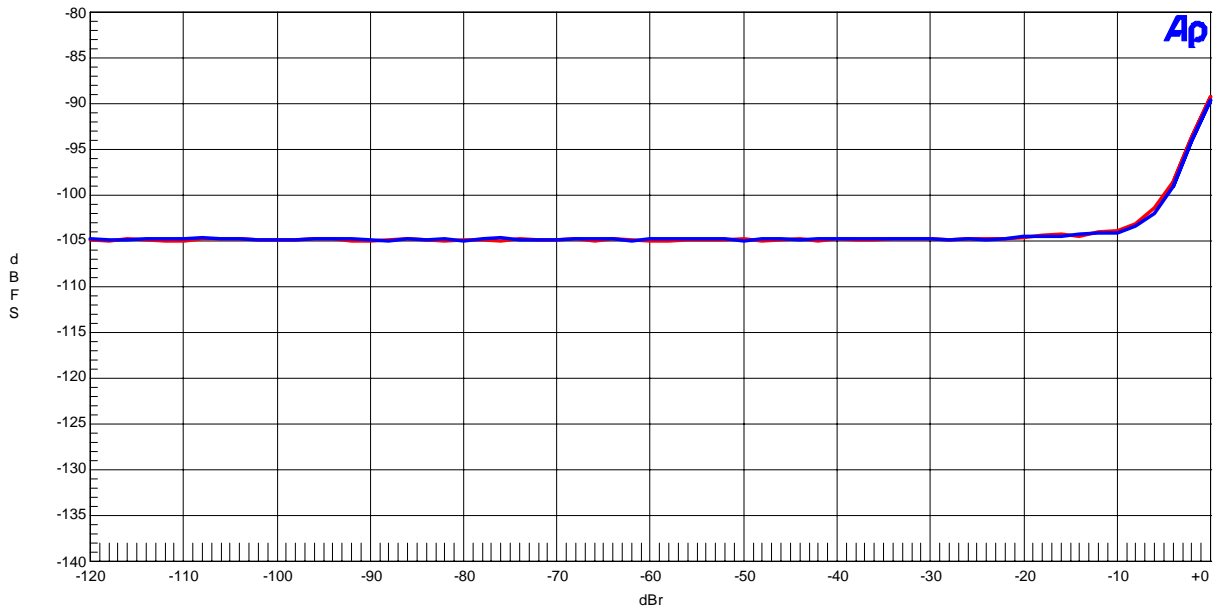

Figure 30. THD+N vs. Input level (fin=1kHz)

(fs=192kHz)

AKM

AK4620 THD+N vs Input Frequency
VA=VT=5V, VD=3.3V, fs=192kHz

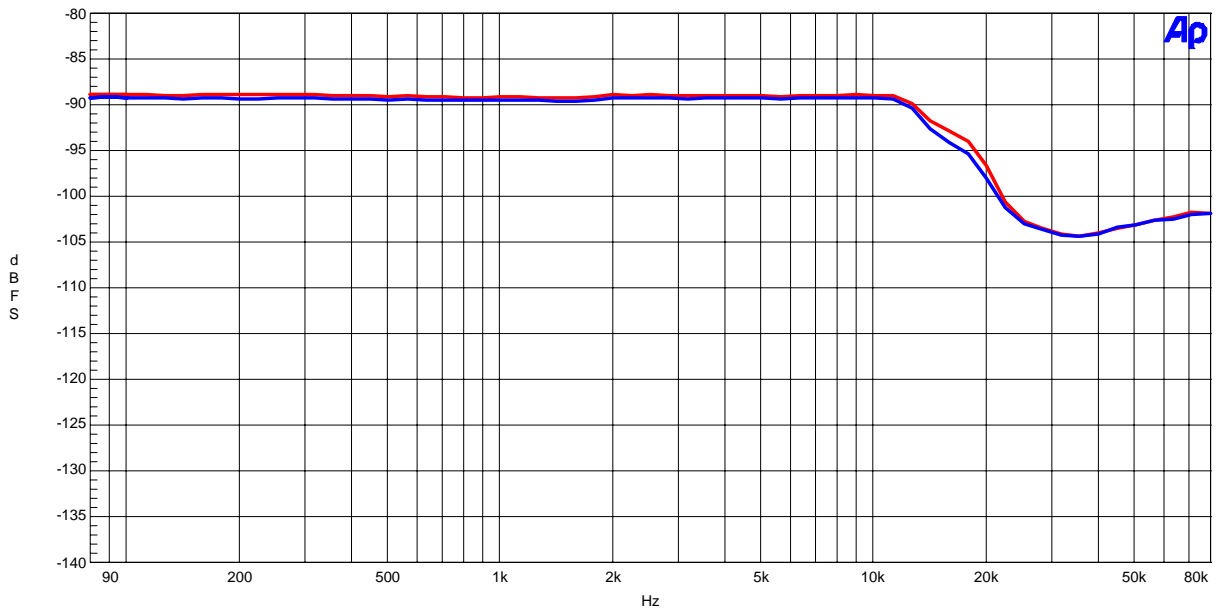

Figure 31. THD+N vs. Input Frequency (Input level=-1dBFS)

AK4620B Linearity
VA=VT=5V, VD=3.3V, fs=192kHz

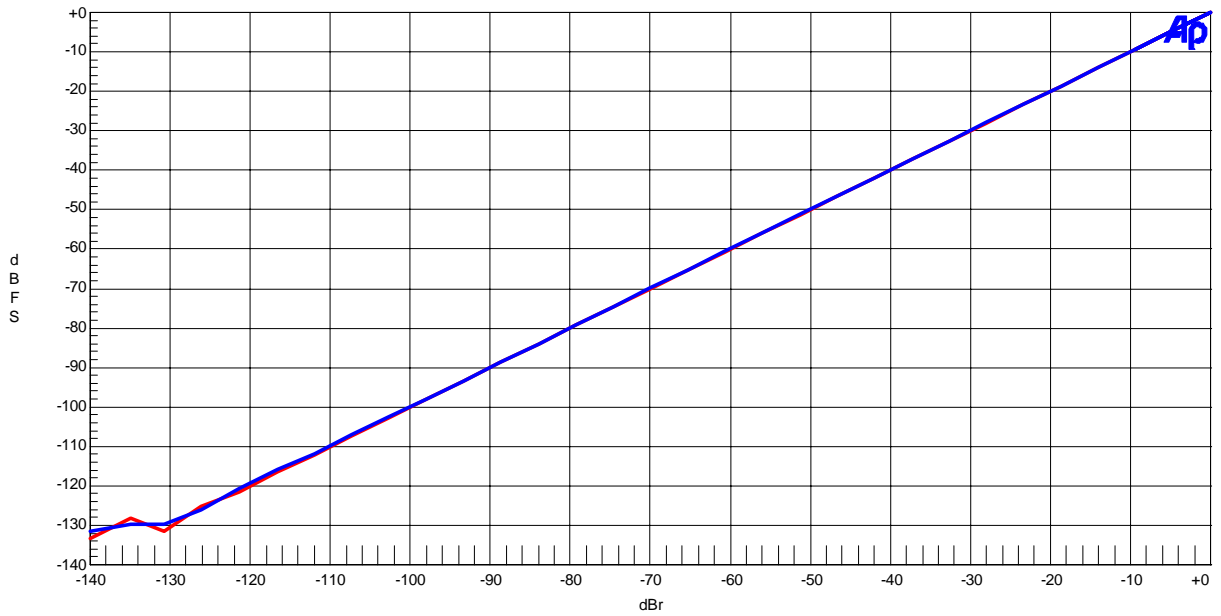

Figure 32. Linearity (fin=1kHz)

(fs=192kHz)

AKM

AK4620 Frequency Respons
VA=VT=5V, VD=3.3V, fs=192kHz

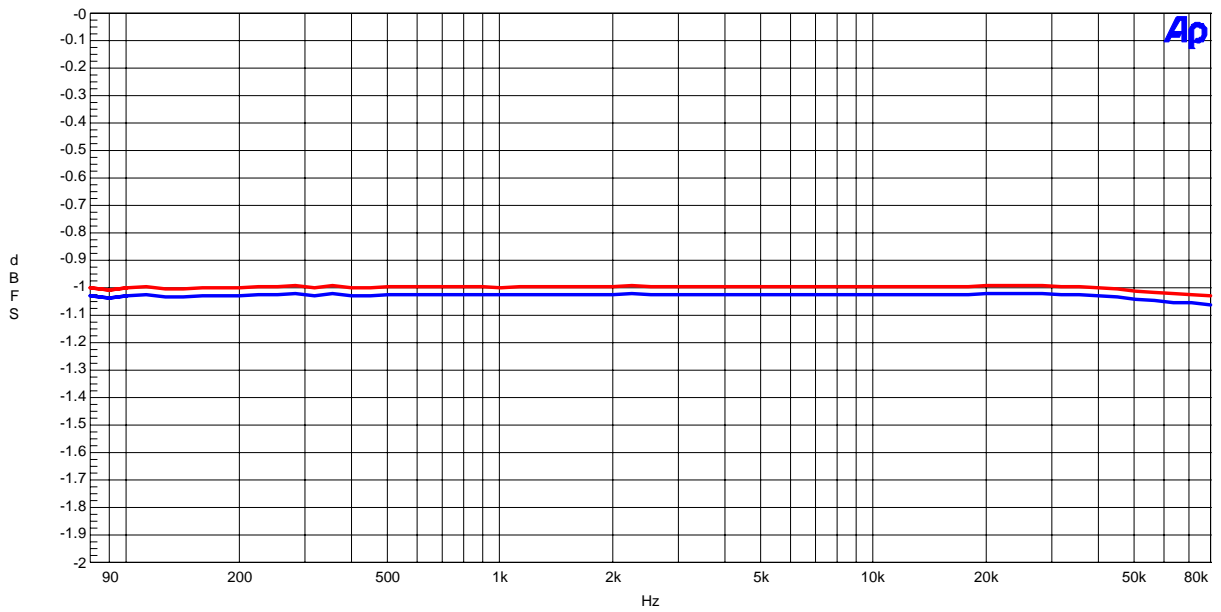

Figure 33. Frequency Response

AKM

AK4620 Crosstalk Lch: Red, Rch: Biue
VA=VT=5V, VD=3.3V, fs=192kHz

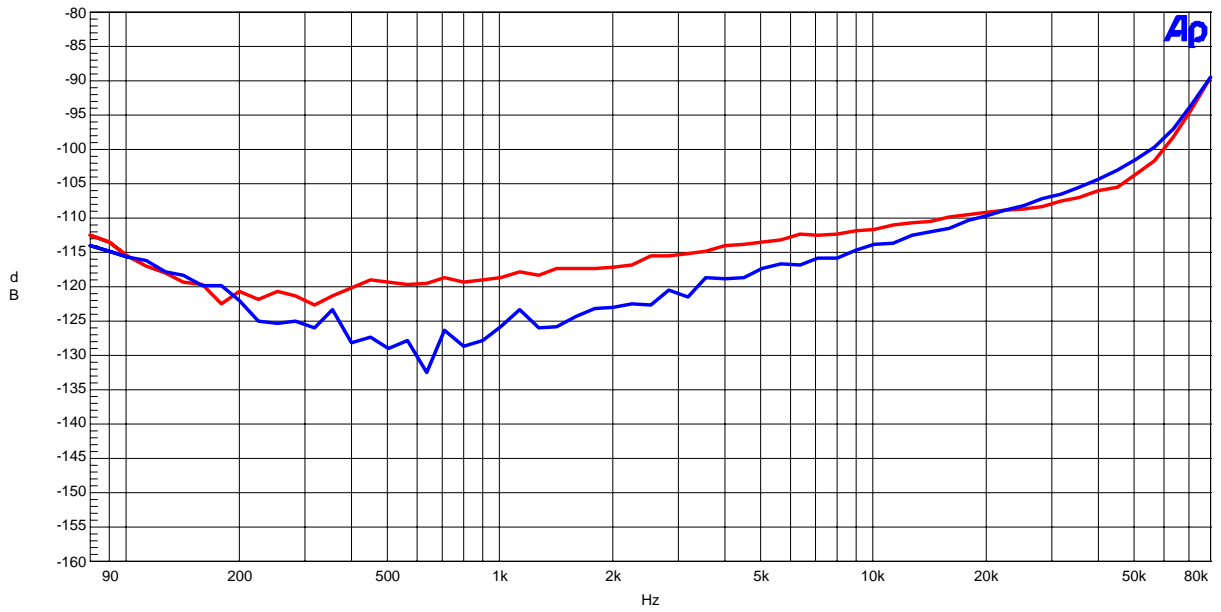

Figure 34. Crosstalk

ADC (Differential)

(fs=44.1kHz)

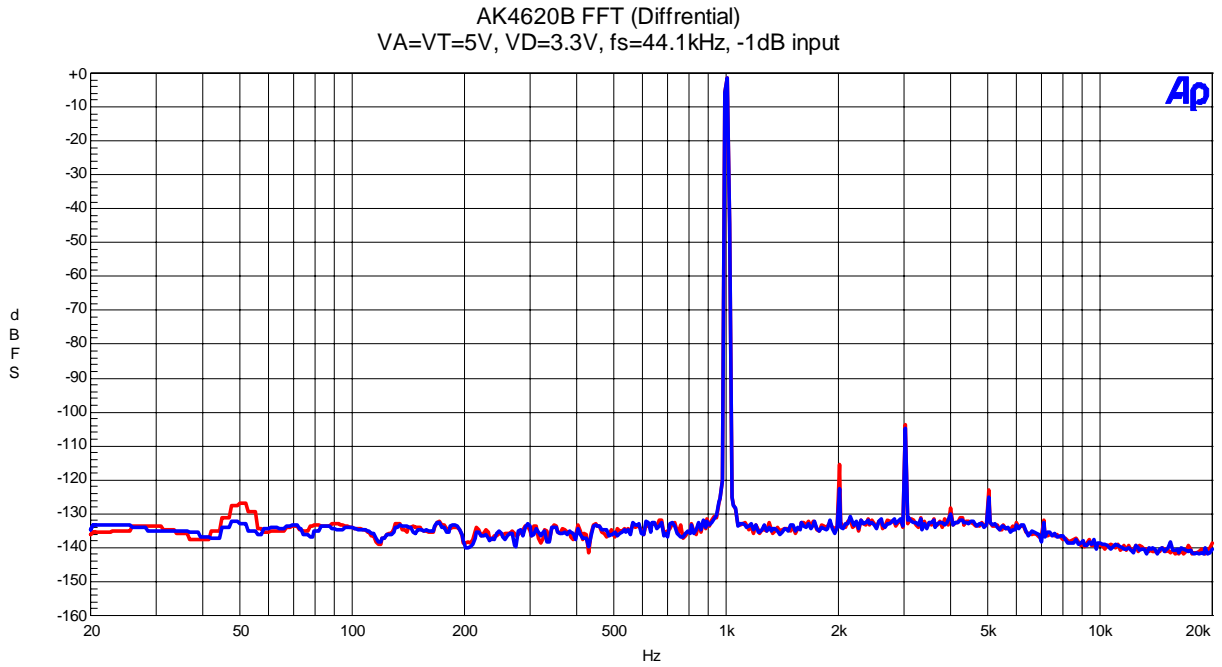

Figure 35. FFT (fin=1kHz, Input Level=-1dBFS)

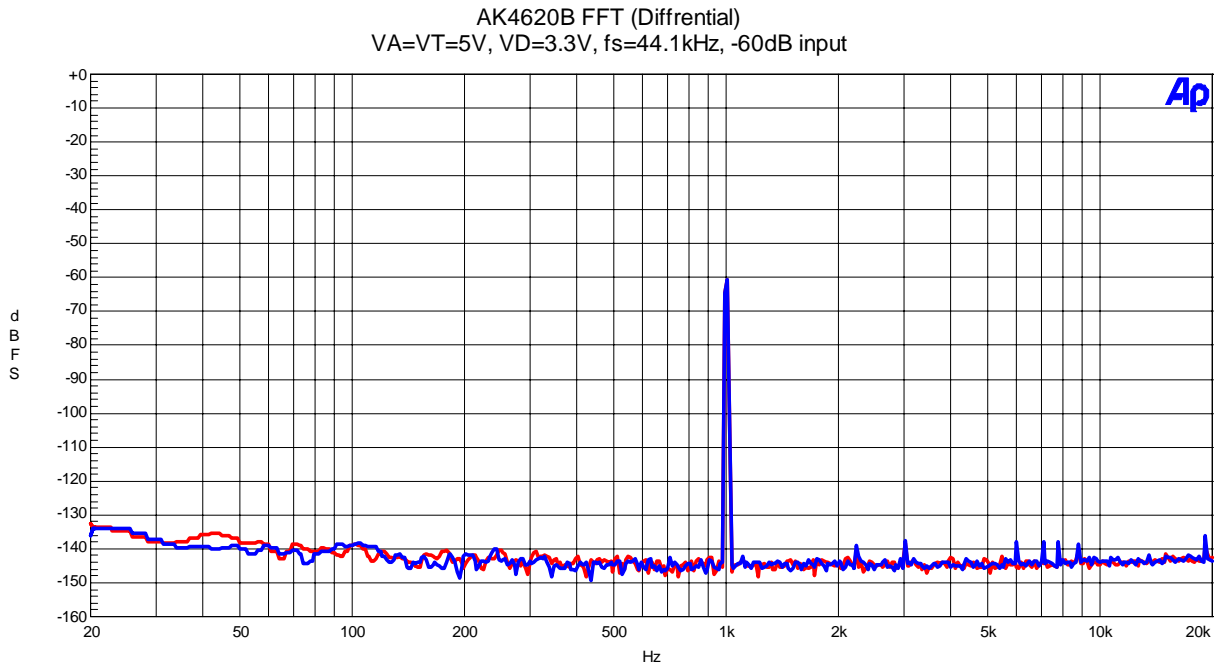

Figure 36. FFT (fin=1kHz, Input Level=-60dBFS)

(fs=44.1kHz)

AK4620B FFT (Differential)
VA=VT=5V, VD=3.3V, fs=44.1kHz, No input

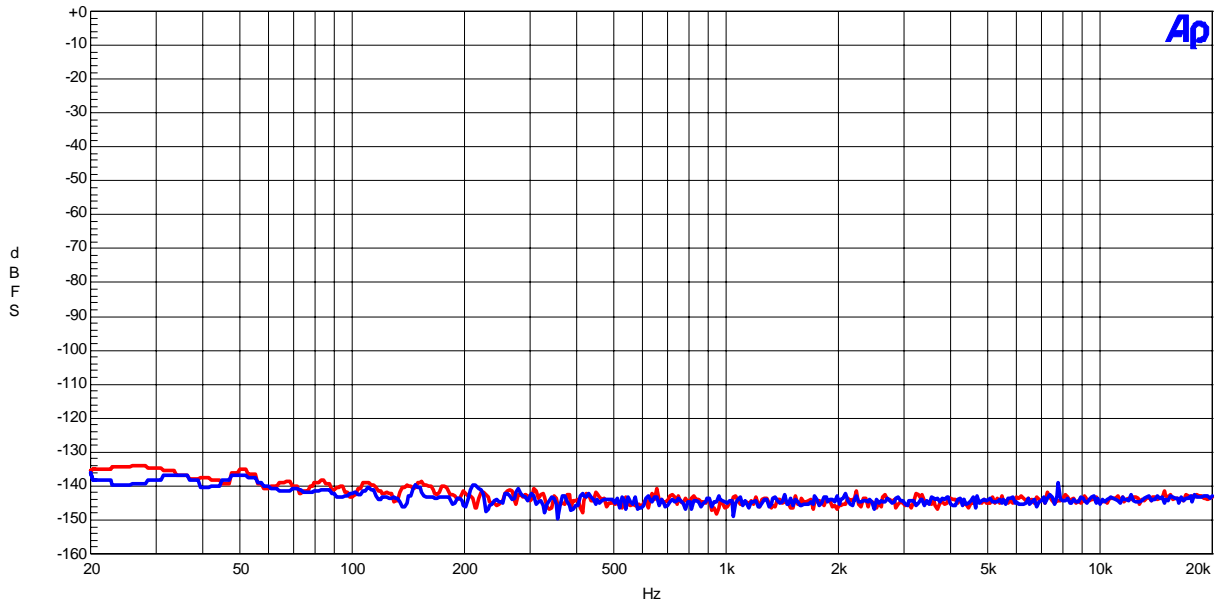

Figure 37. FFT (Noise Floor)

AK4620B THD+N vs Input Level
VA=VT=5V, VD=3.3V, fs=44.1kHz

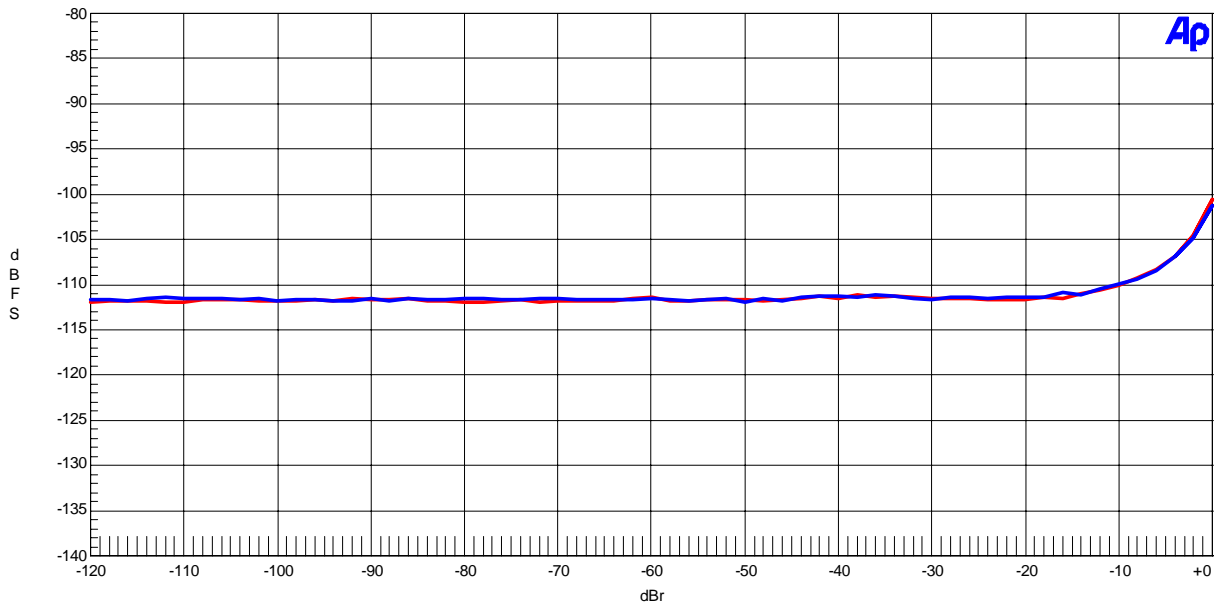

Figure 38. THD+N vs. Input level (fin=1kHz)

(fs=44.1kHz)

AK4620B THD+N vs Input Frequency
VA=VT=5V, VD=3.3V, fs=44.1kHz

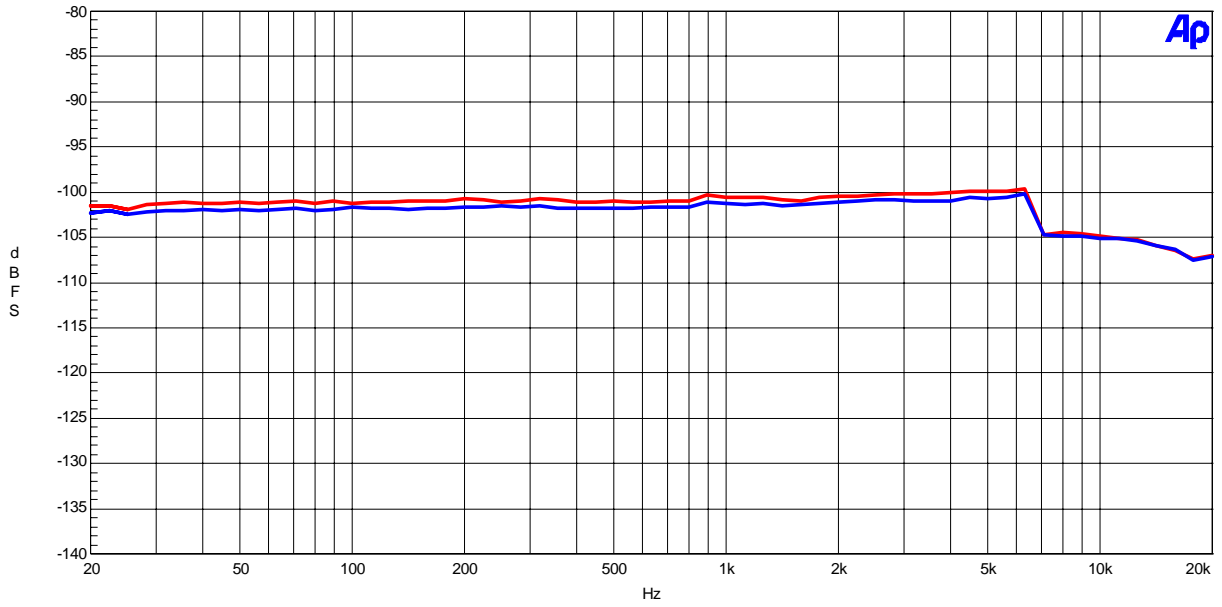

Figure 39. THD +N vs. Input Frequency (Input level=-1dBFS)

AK4620B Linearity
VA=VT=5V, VD=3.3V, fs=44.1kHz

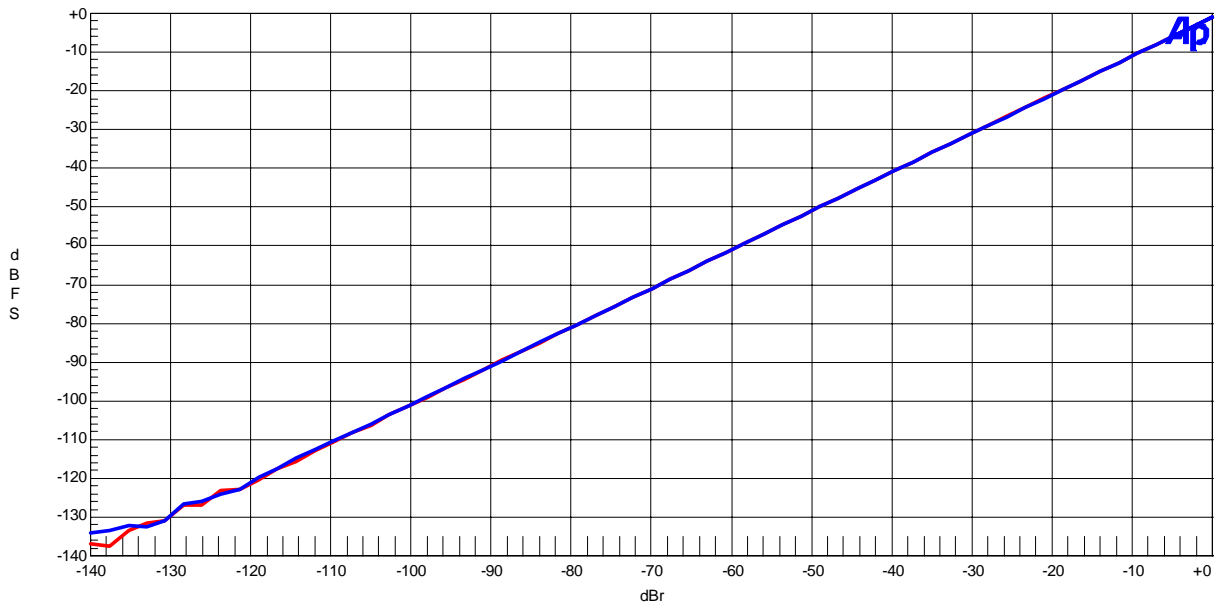

Figure 40. Linearity (fin=1kHz)

(fs=44.1kHz)

AK4620B Frequency Respons
VA=VT=5V, VD=3.3V, fs=44.1kHz

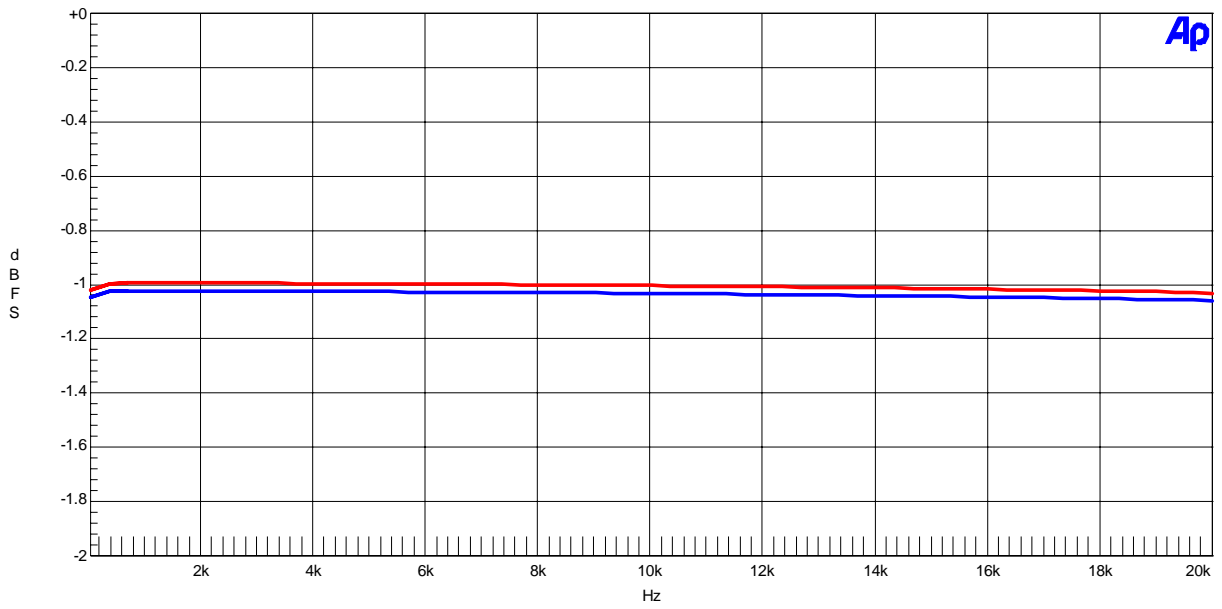

Figure 41. Frequency Response

AK4620B Crosstalk Lch: Red, Rch: Blue
VA=VT=5V, VD=3.3V, fs=44.1kHz

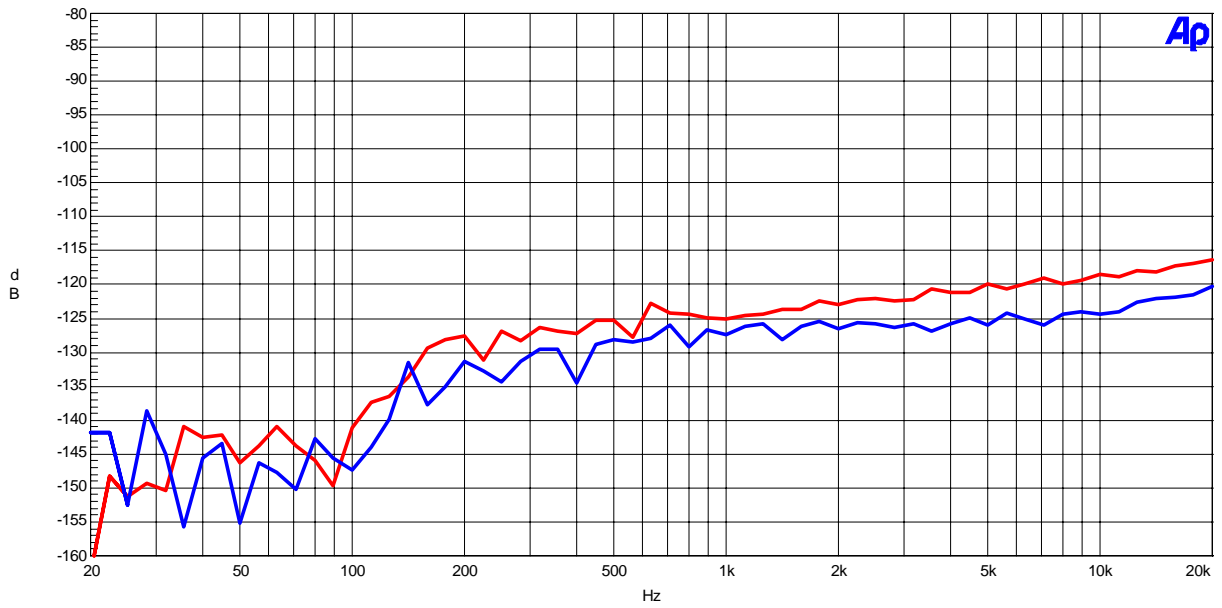

Figure 42. Crosstalk

(fs=96kHz)

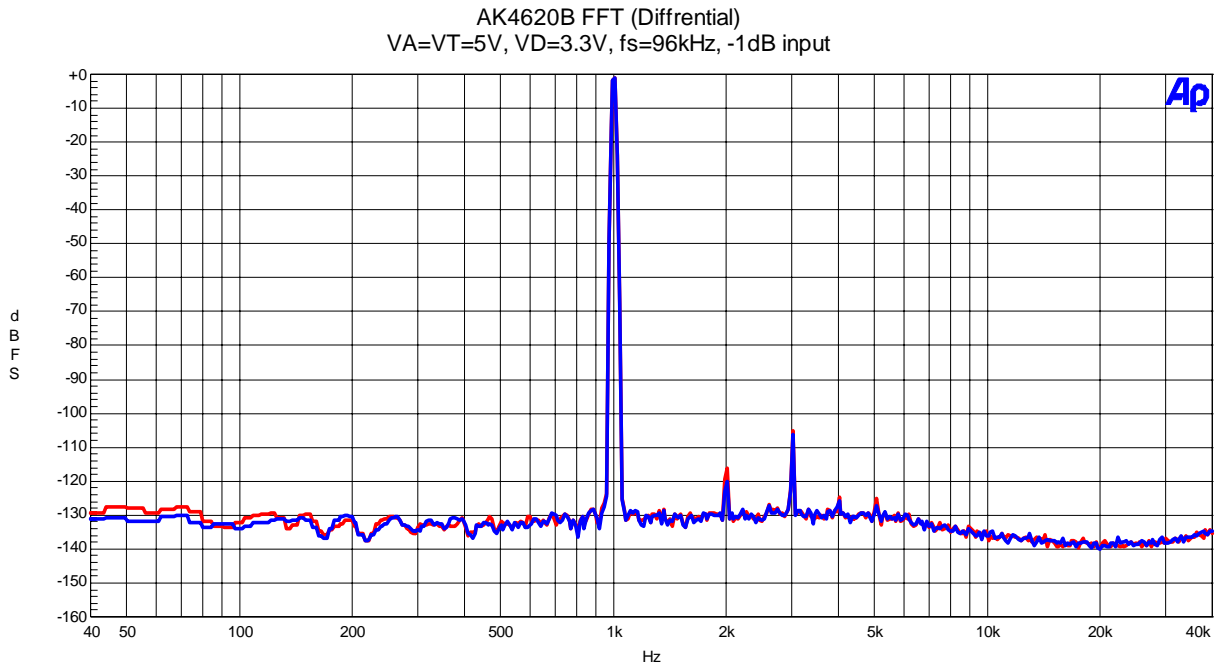

Figure 43. FFT (fin=1kHz, Input Level=-1dBFS)

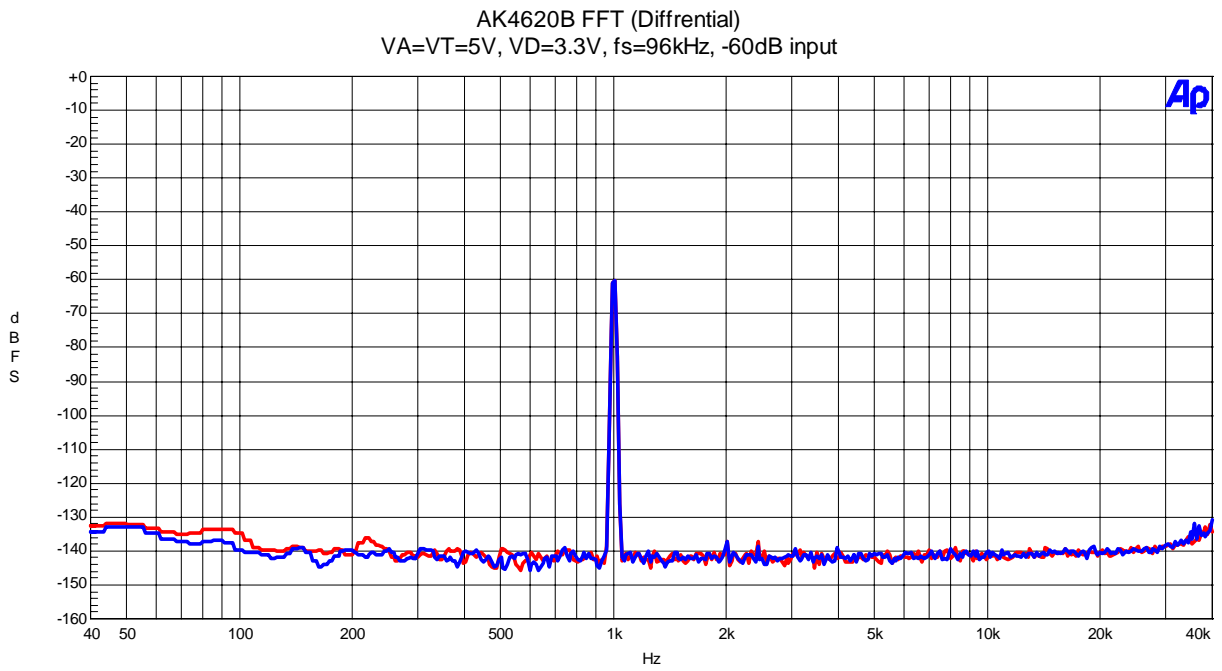

Figure 44. FFT (fin=1kHz, Input Level=-60dBFS)

(fs=96kHz)

AK4620B FFT (Differential)
VA=VT=5V, VD=3.3V, fs=96kHz, No input

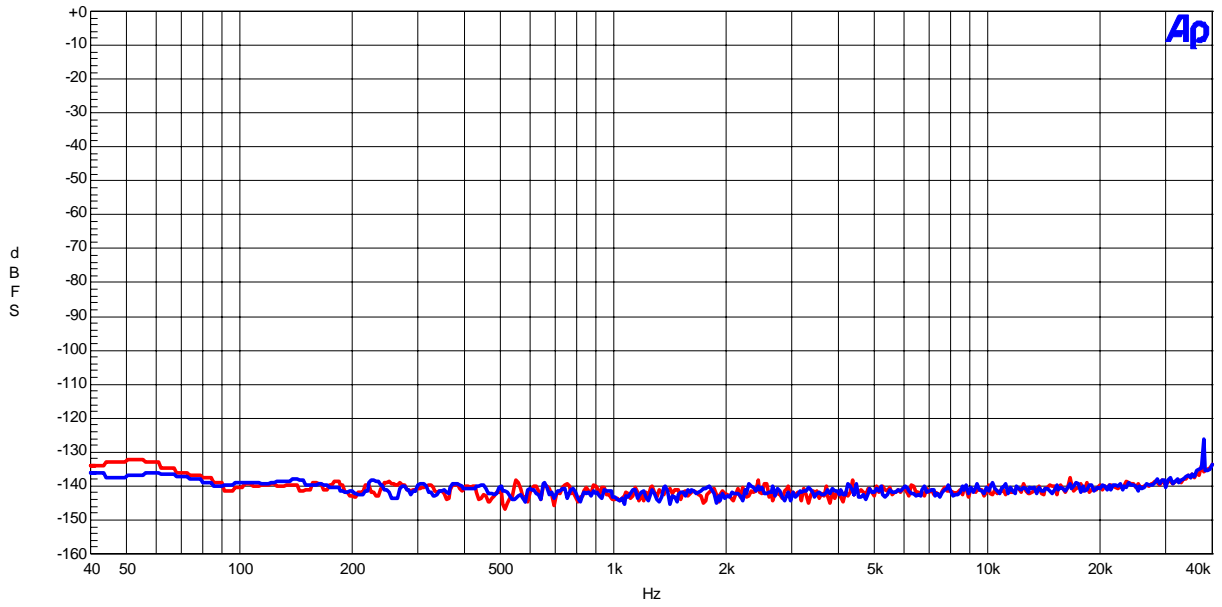

Figure 45. FFT (Noise Floor)

AK4620B THD+N vs Input Level
VA=VT=5V, VD=3.3V, fs=96kHz

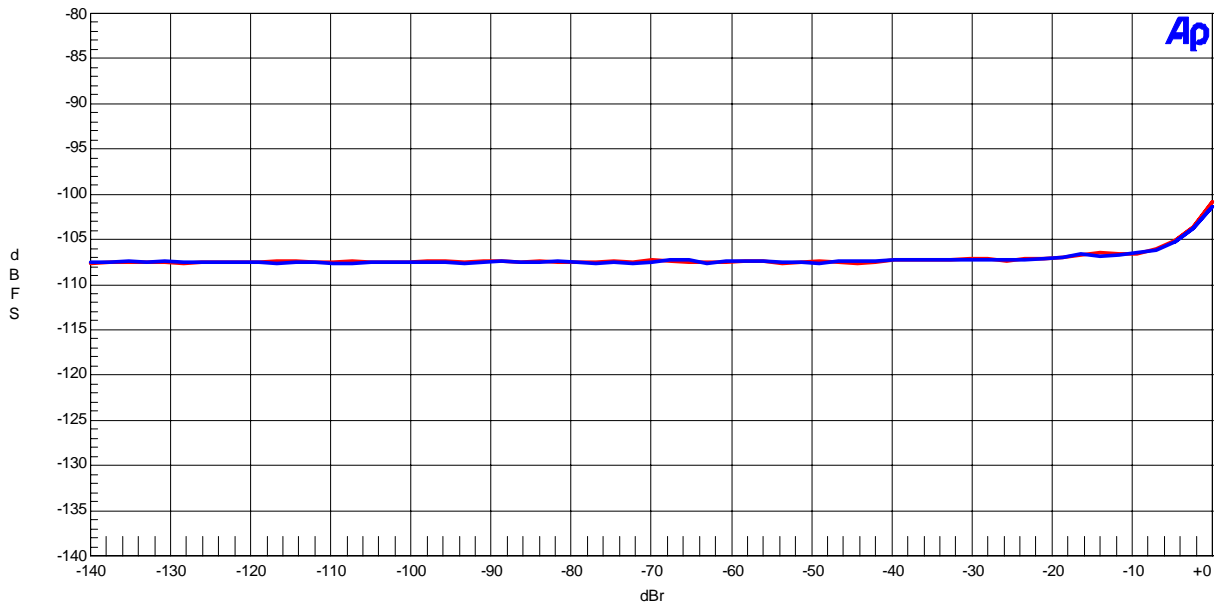

Figure 46. THD +N vs. Input level (fin=1kHz)

(fs=96kHz)

AK4620B THD+N vs Input Frequency
VA=VT=5V, VD=3.3V, fs=96kHz

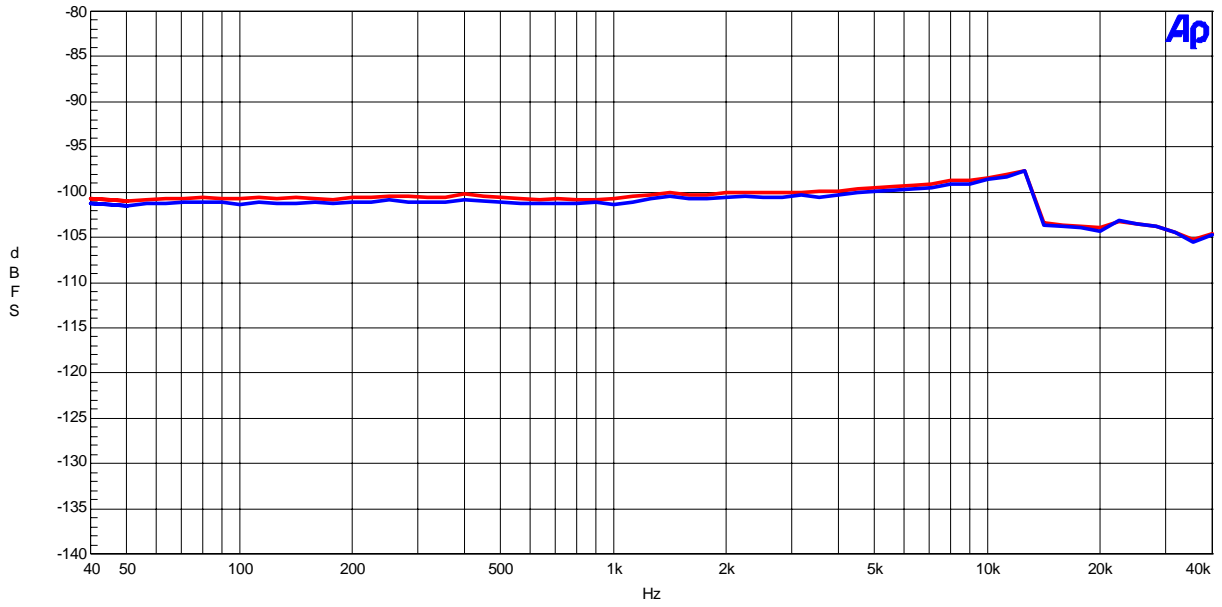

Figure 47. THD +N vs. Input Frequency (Input level=-1dBFS)

AK4620B Linearity
VA=VT=5V, VD=3.3V, fs=96kHz

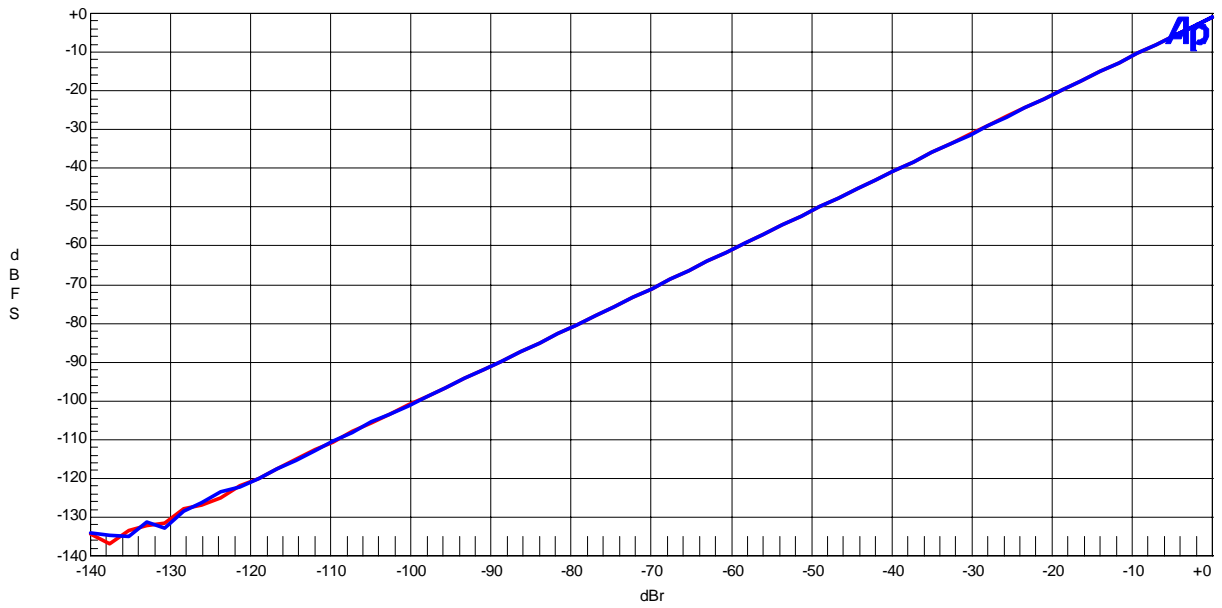

Figure 48. Linearity (fin=1kHz)

(fs=96kHz)

AK4620B Frequency Respons
VA=VT=5V, VD=3.3V, fs=96kHz

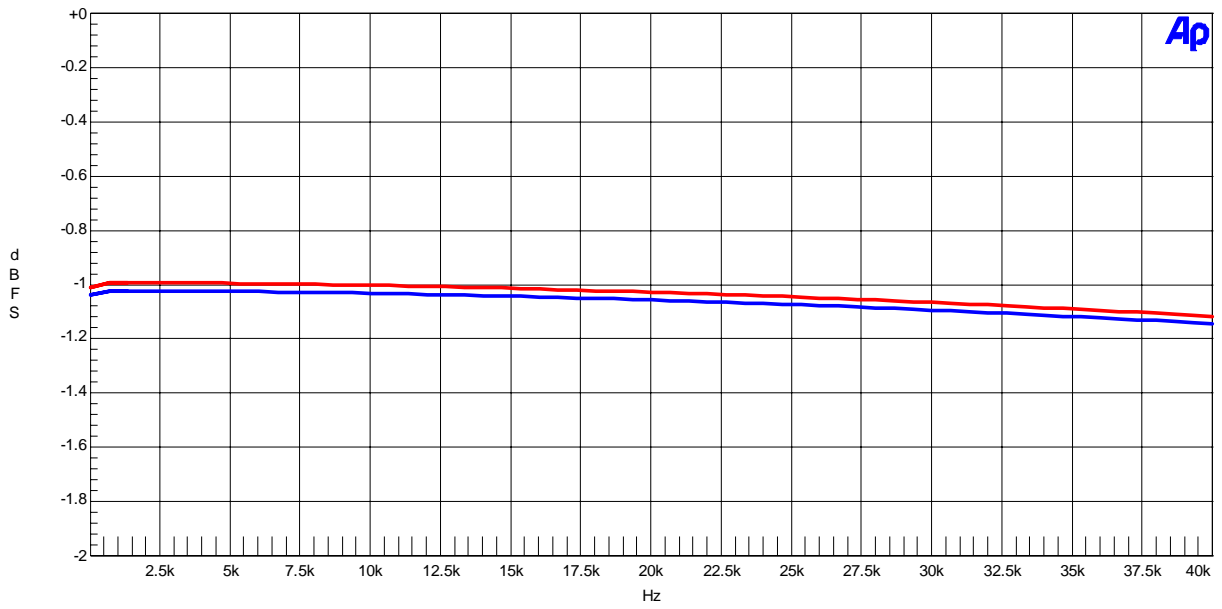

Figure 49. Frequency Response

AK4620B Crosstalk Lch :Red, Rch: Blue
VA=VT=5V, VD=3.3V, fs=96kHz

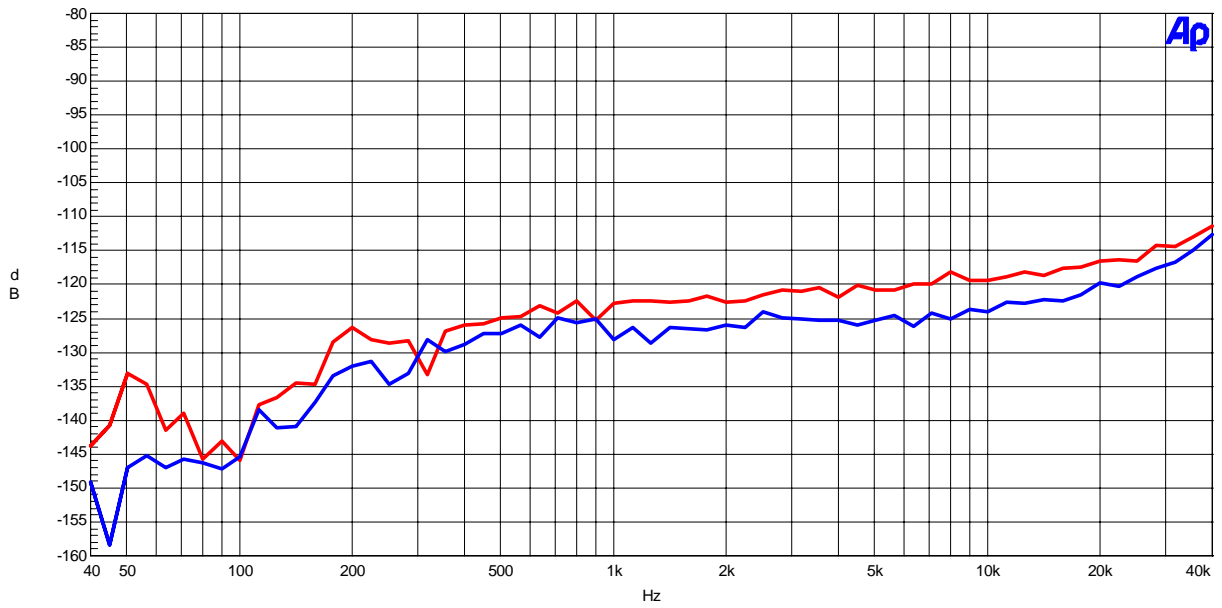

Figure 50. Crosstalk

(fs=192kHz)

AKM

AK4620 FFT (Differential)
VA=VT=5V, VD=3.3V, fs=192kHz, -1dB input

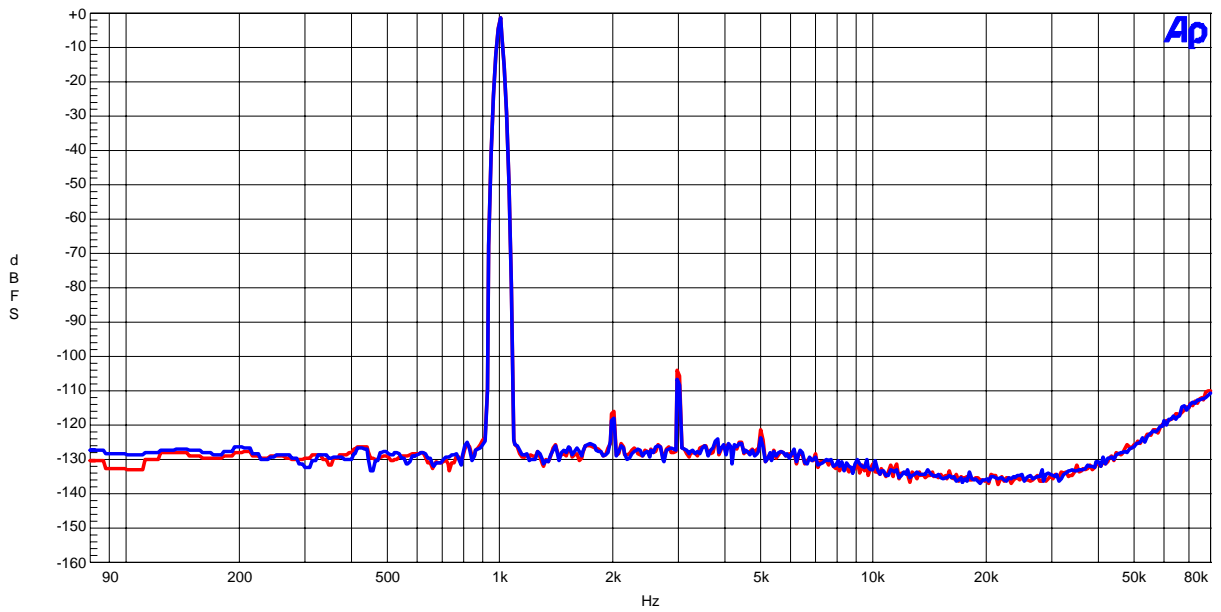

Figure 51. FFT (fin=1kHz, Input Level=-1dBFS)

AKM

AK4620 FFT (Differential)
VA=VT=5V, VD=3.3V, fs=192kHz, -60dB input

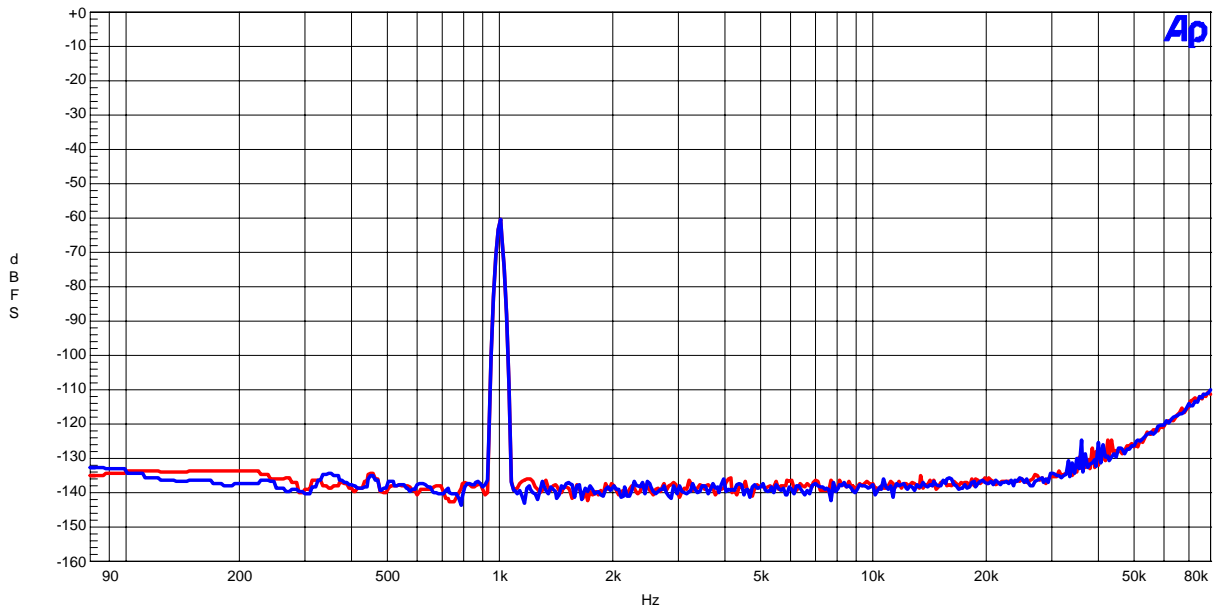

Figure 52. FFT (fin=1kHz, Input Level=-60dBFS)

(fs=192kHz)

AKM

AK4620 FFT (Differential)
VA=VT=5V, VD=3.3V, fs=192kHz, No input

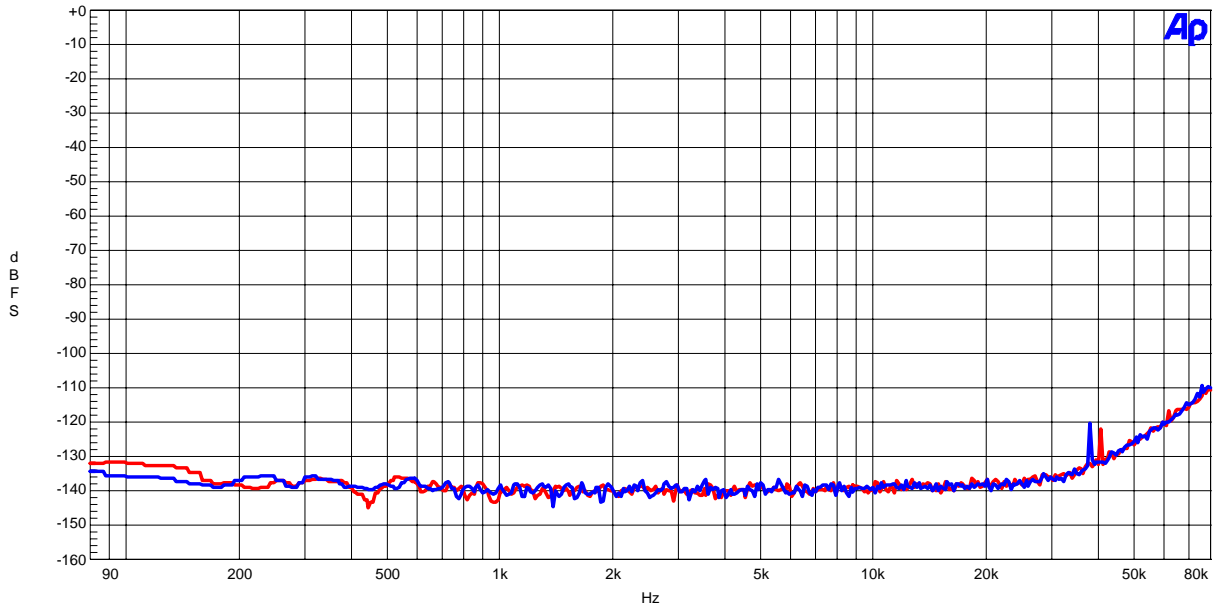

Figure 53. FFT (Noise Floor)

AKM

AK4620 THD+N vs Input Level
VA=VT=5V, VD=3.3V, fs=192kHz

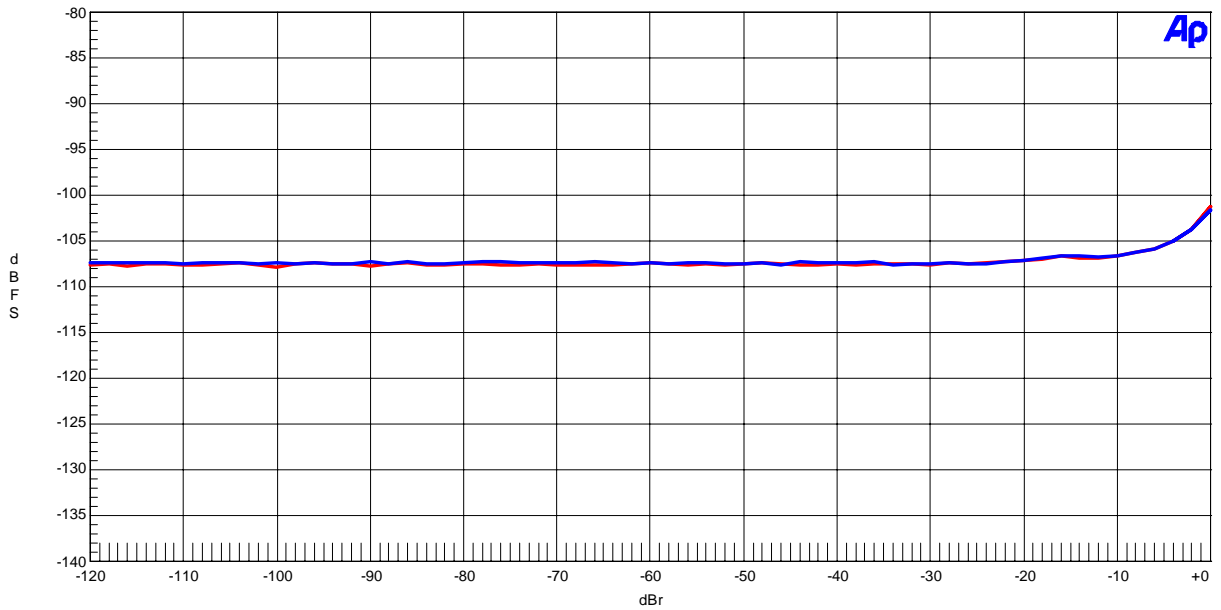

Figure 54. THD+N vs. Input level (fin=1kHz)

(fs=192kHz)

AKM

AK4620 THD+N vs Input Frequency
VA=VT=5V, VD=3.3V, fs=192kHz

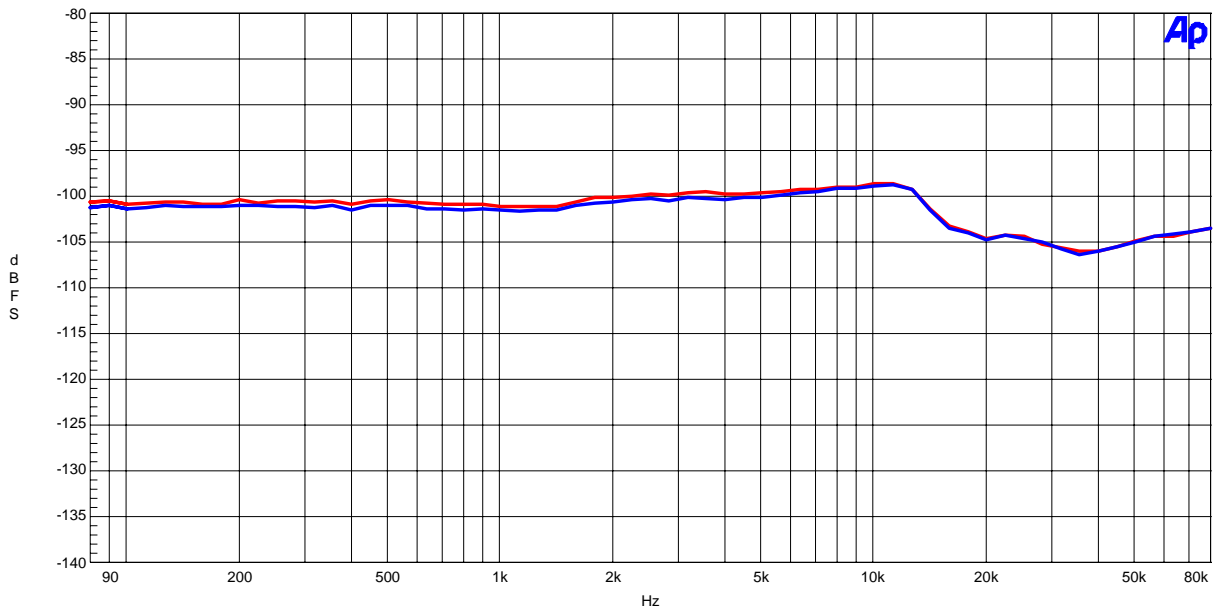

Figure 55. THD+N vs. Input Frequency (Input level=-1dBFS)

AKM

AK4620 Linearity
VA=VT=5V, VD=3.3V, fs=192kHz

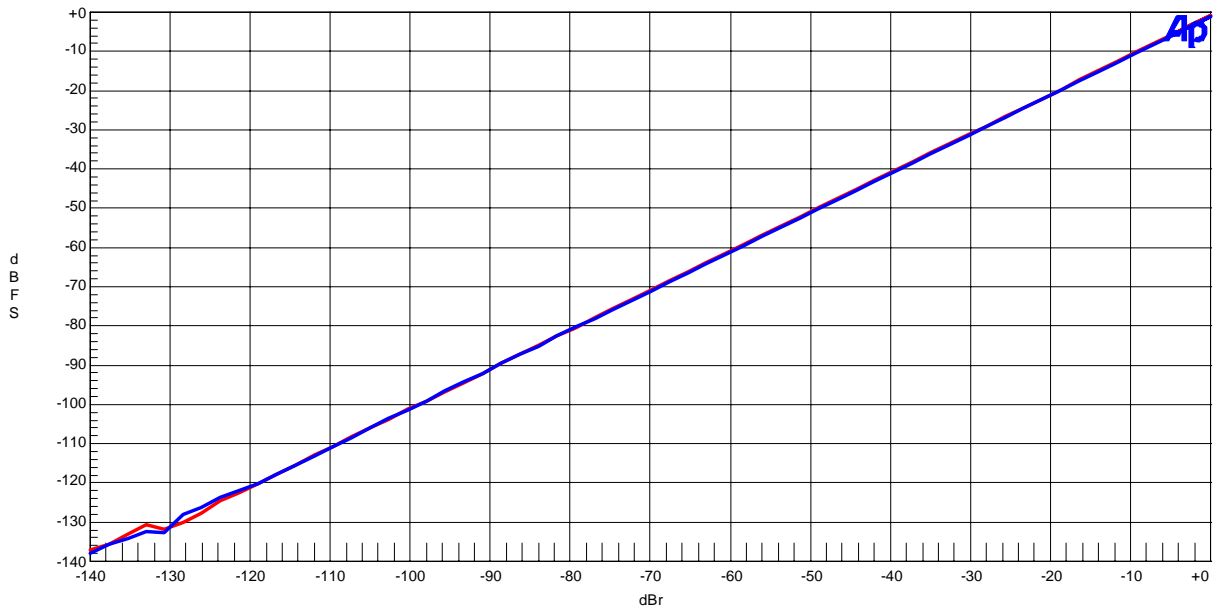

Figure 56. Linearity (fin=1kHz)

(fs=192kHz)

AKM

AK4620 Frequency Respons
VA=VT=5V, VD=3.3V, fs=192kHz

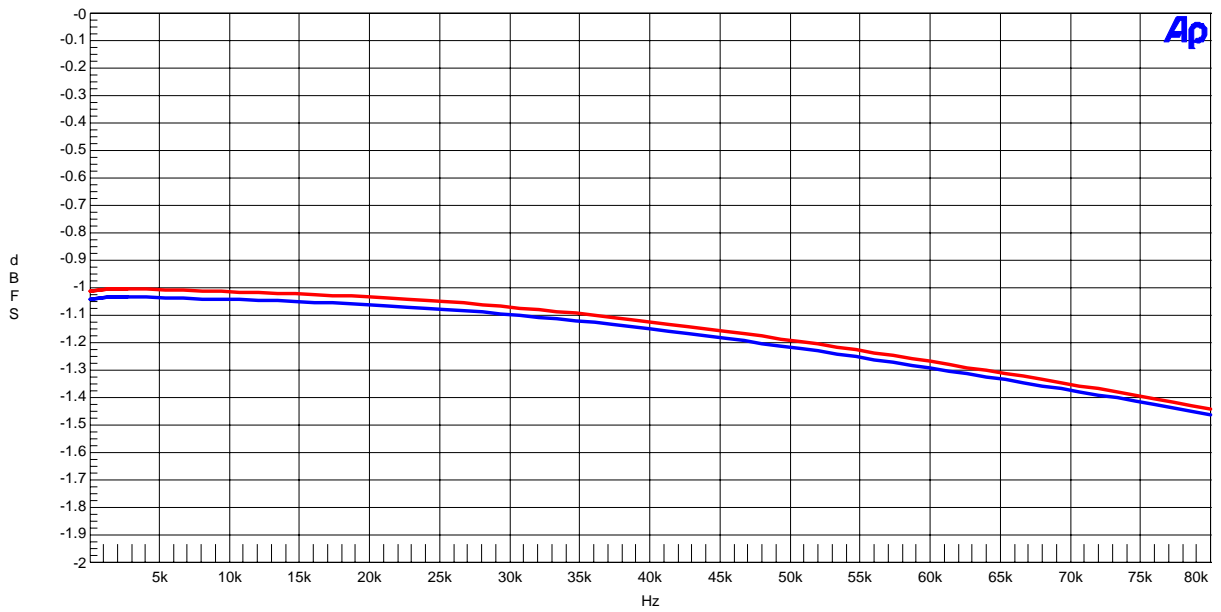

Figure 57. Frequency Response

AKM

AK4620 Crosstalk Lch: Red, Rch: Biue
VA=VT=5V, VD=3.3V, fs=192kHz

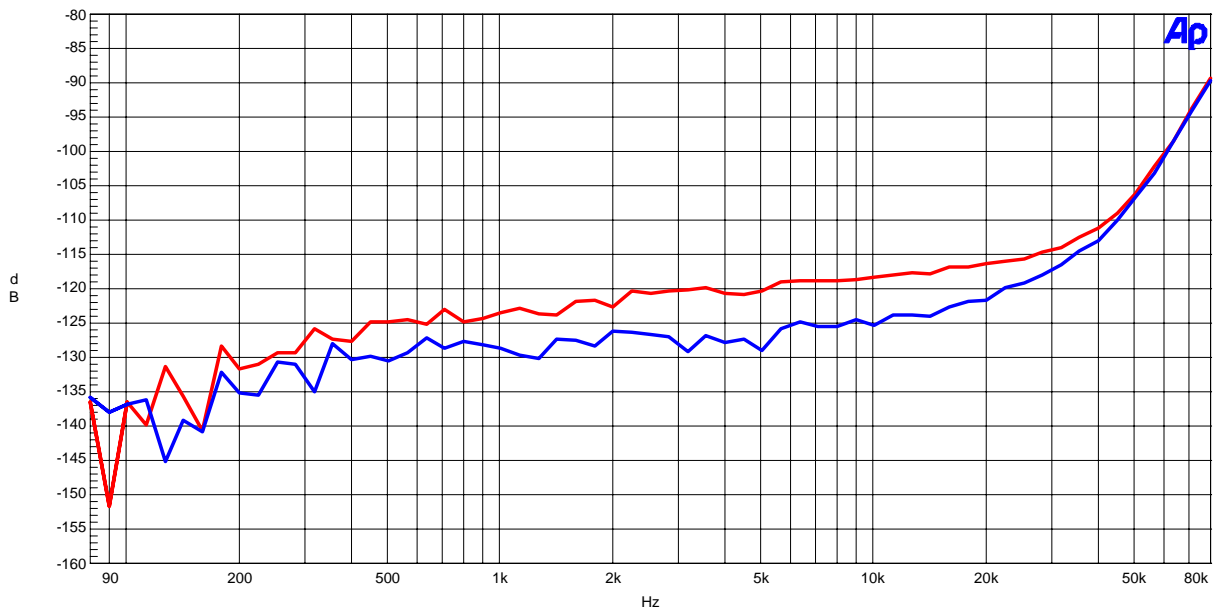

Figure 58. Crosstalk

DAC

(fs=44.1kHz)

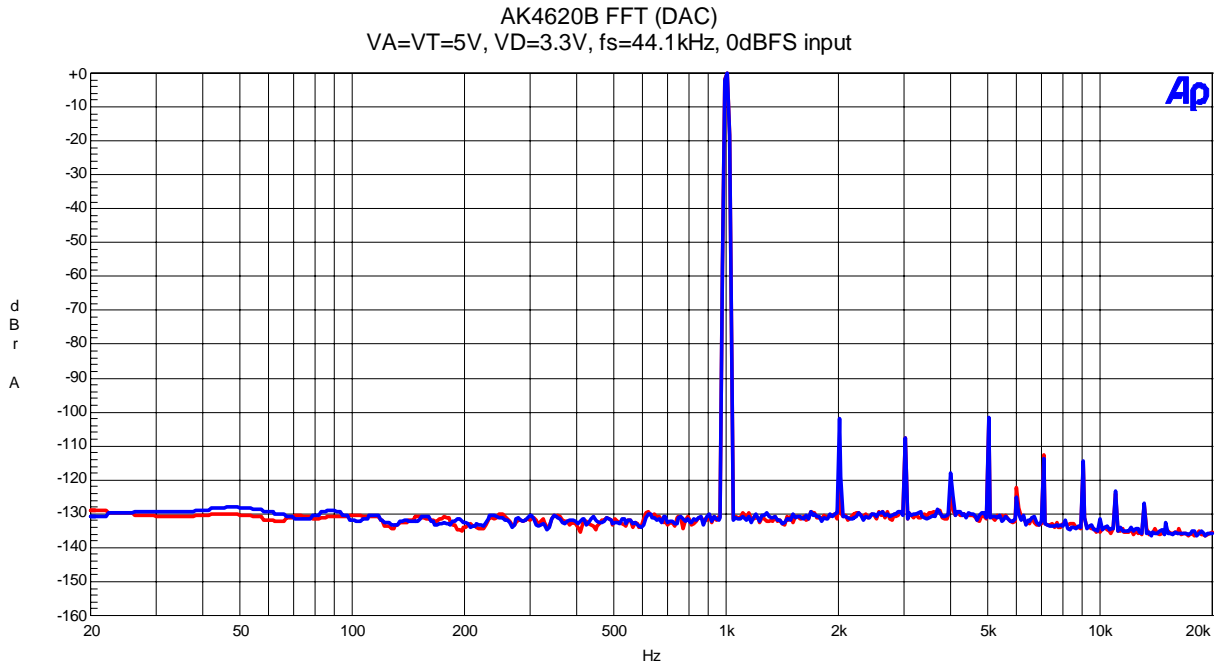

Figure 59. FFT (fin=1kHz, Input Level=0BFS)

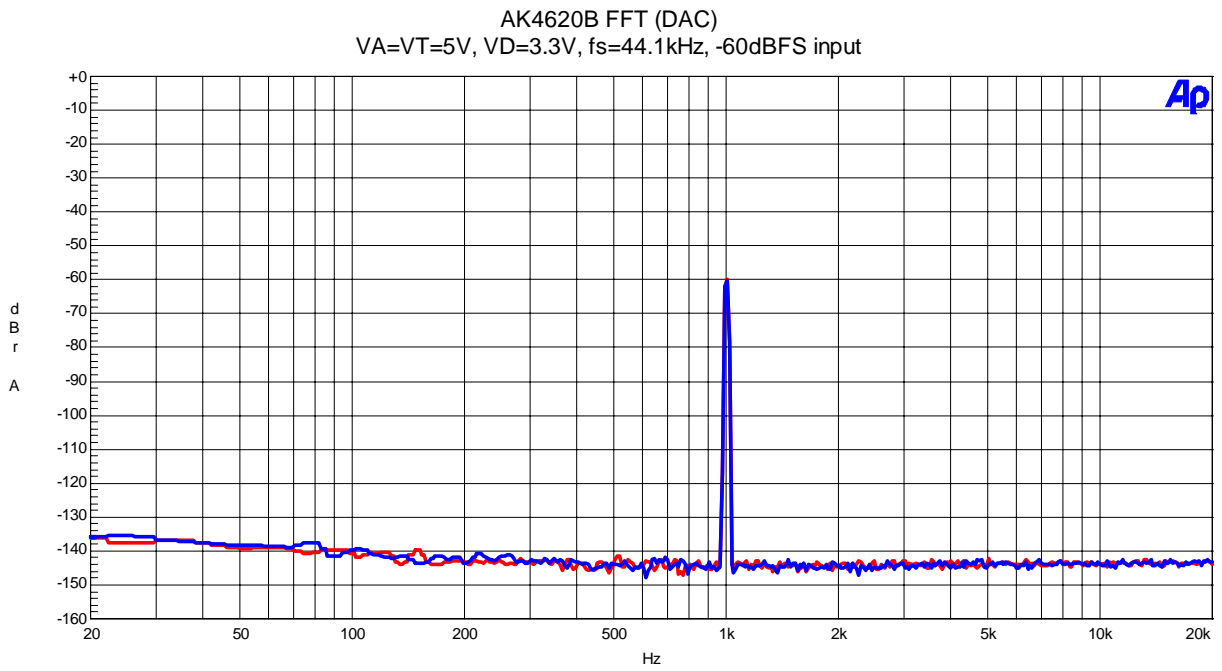

Figure 60. FFT (fin=1kHz, Input Level=-60dBFS)

(fs=44.1kHz)

AK4620B FFT (DAC)
VA=VT=5V, VD=3.3V, fs=44.1kHz, No input

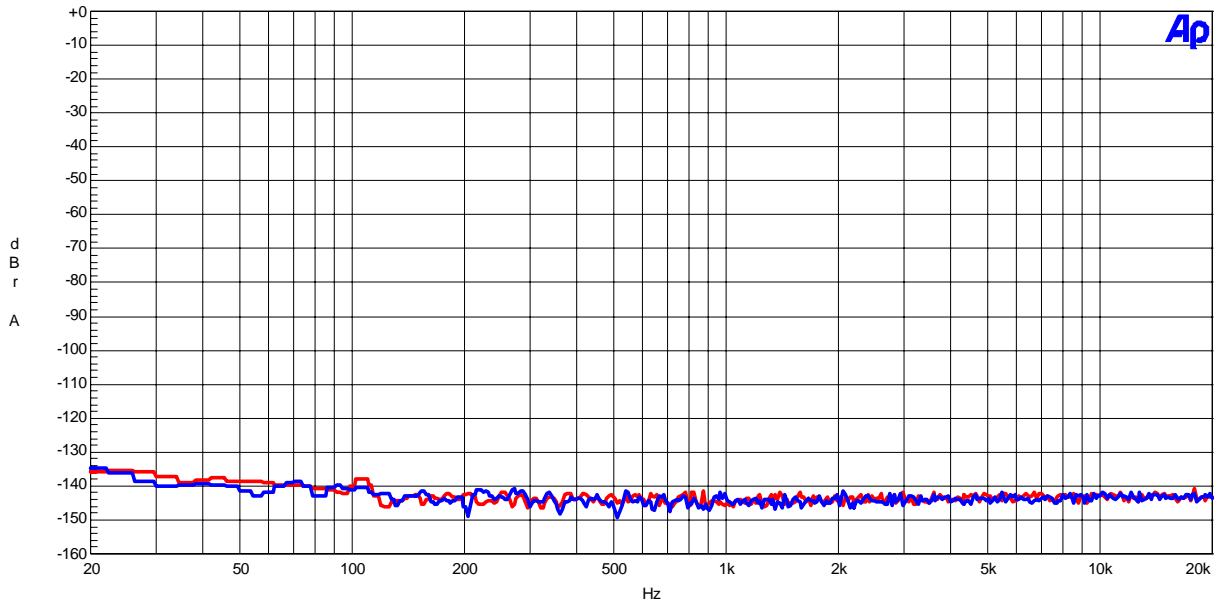

Figure 61. FFT (Noise Floor)

AK4620B THD+N vs Input Level
VA=VT=5V, VD=3.3V, fs=44.1kHz

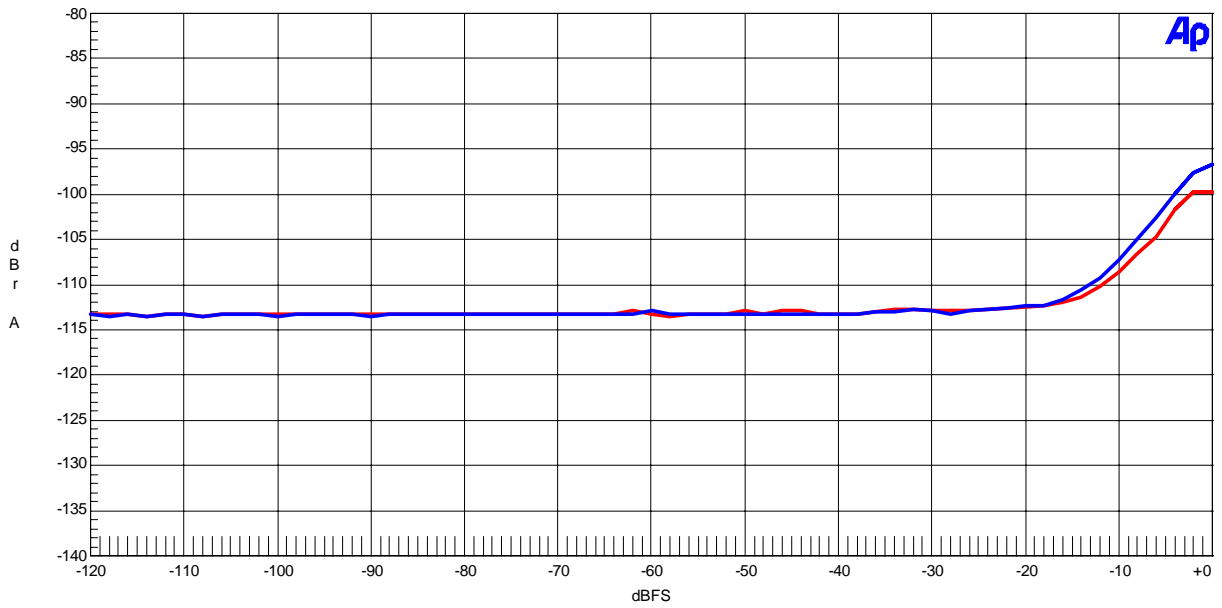

Figure 62. THD+N vs. Input level (fin=1kHz)

(fs=44.1kHz)

AK4620B THD+N vs Input Frequency
VA=VT=5V, VD=3.3V, fs=44.1kHz

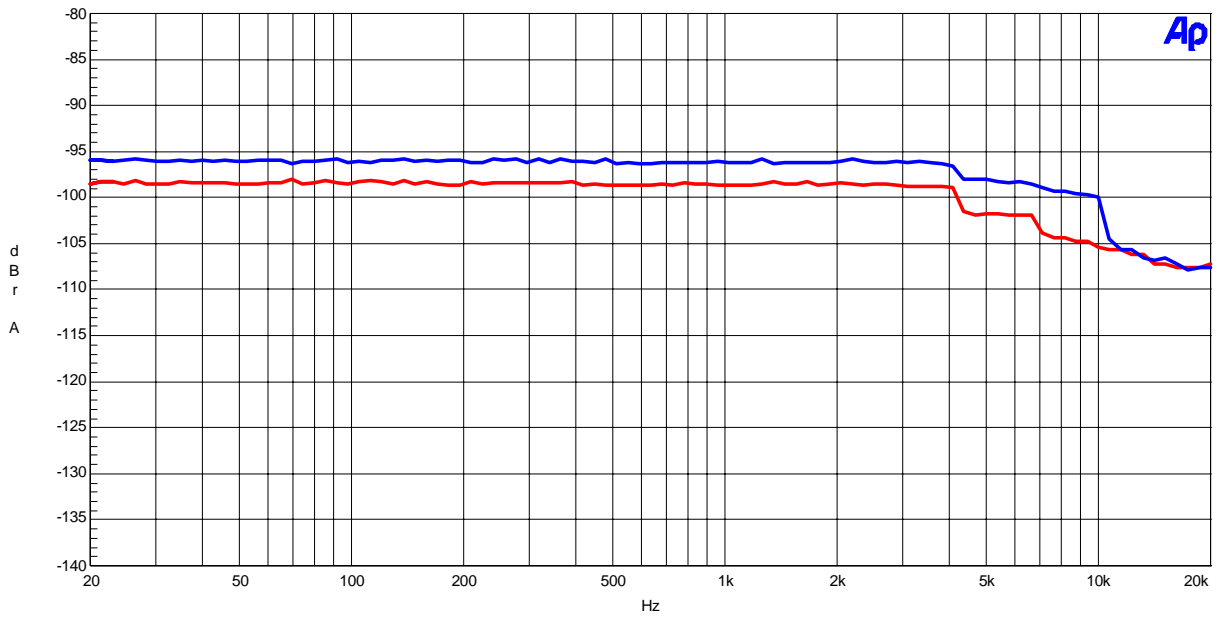

Figure 63. THD +N vs. Input Frequency (Input level=0dBFS)

AK4620B Linearity
VA=VT=5V, VD=3.3V, fs=44.1kHz

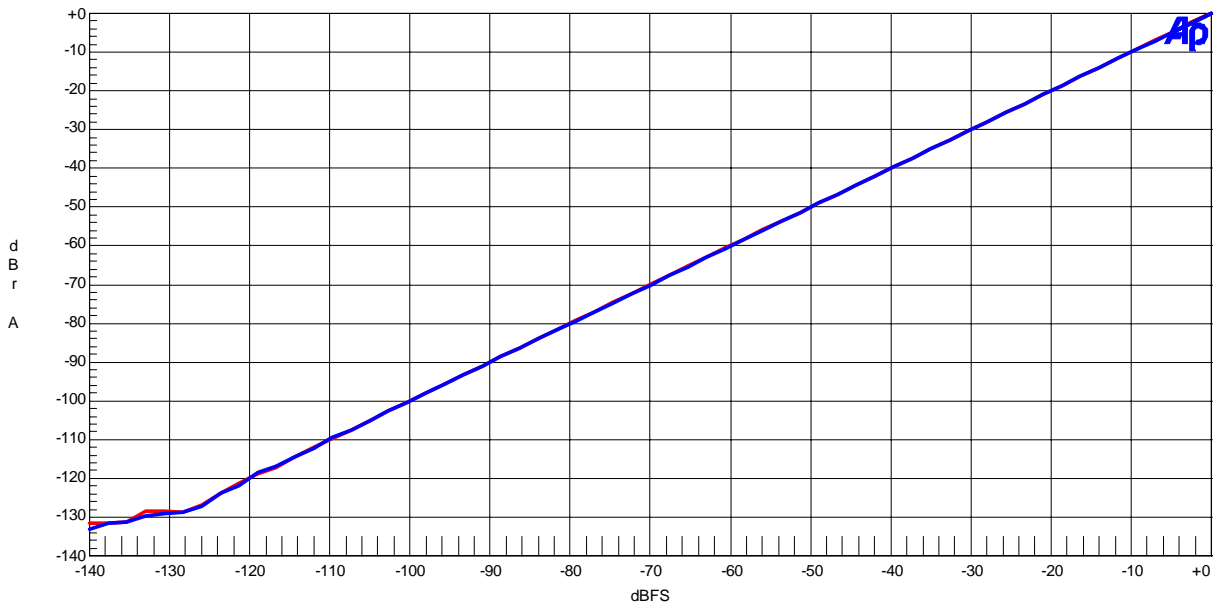

Figure 64. Linearity (fin=1kHz)

(fs=44.1kHz)

AK4620B Frequency Respons
VA=VT=5V, VD=3.3V, fs=44.1kHz

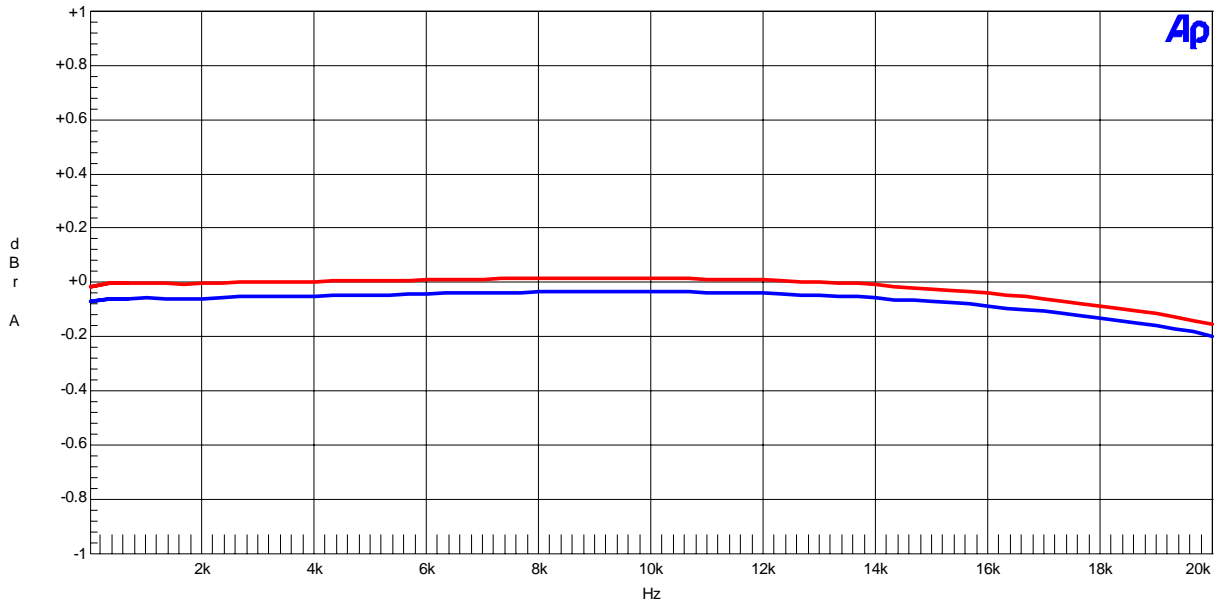

Figure 65. Frequency Response (Input level=0dBFS)

AK4620B Crosstalk Lch: Red, Rch: Blue
VA=VT=5V, VD=3.3V, fs=44.1kHz

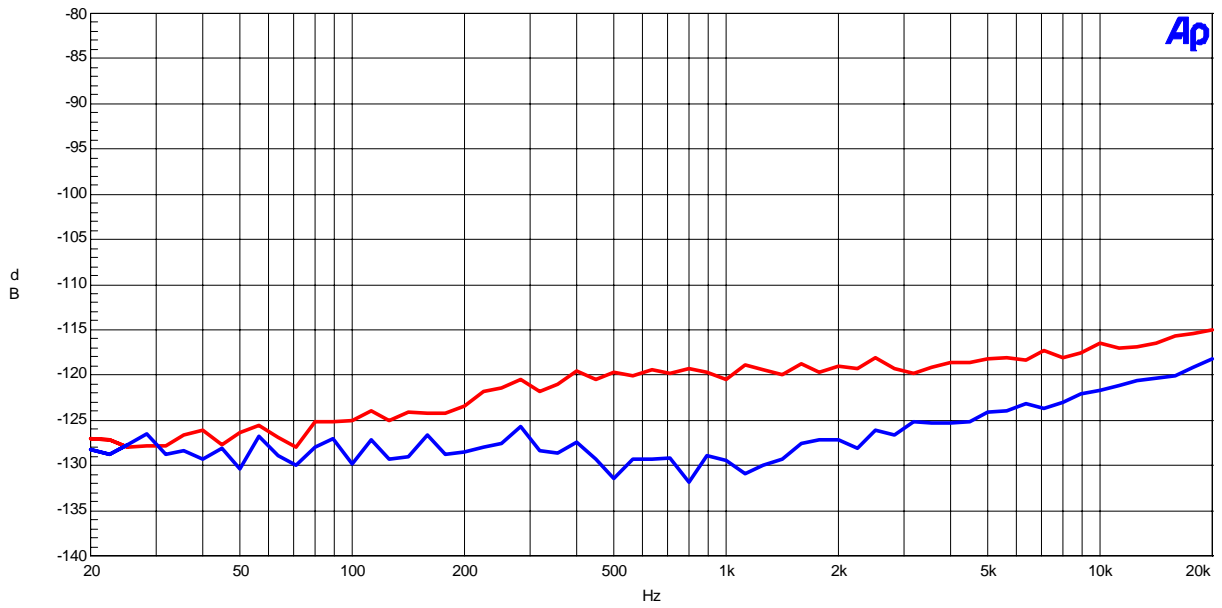

Figure 66. Crosstalk

(fs=44.1kHz)

AK4620B FFT (DAC) Out-band noise
VA=VT=5V, VD=3.3V, fs=44.1kHz, No input

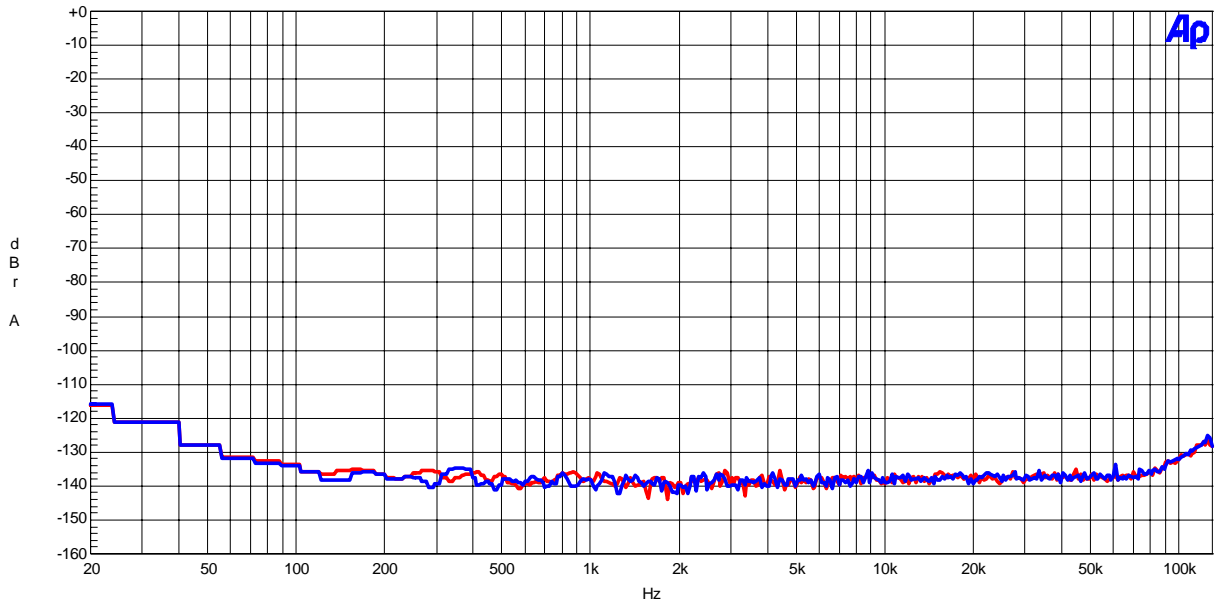

Figure 67. Out-of-band Noise

(fs=96kHz)

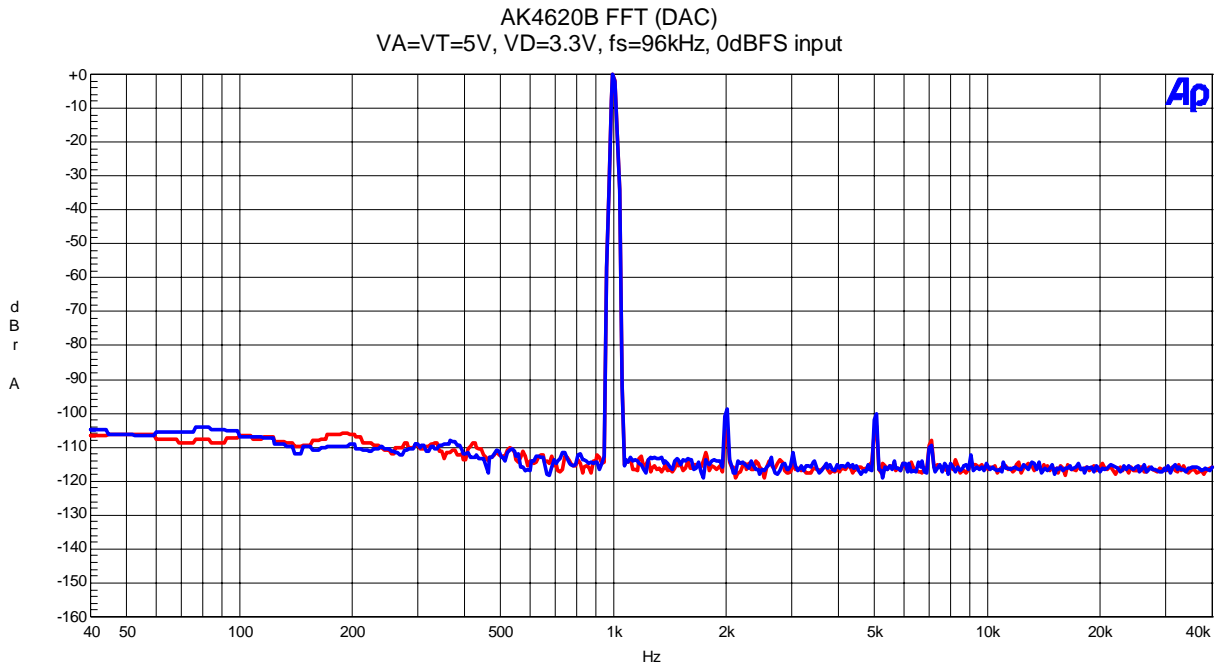

Figure 68. FFT (fin=1kHz, Input Level=0dBFS)

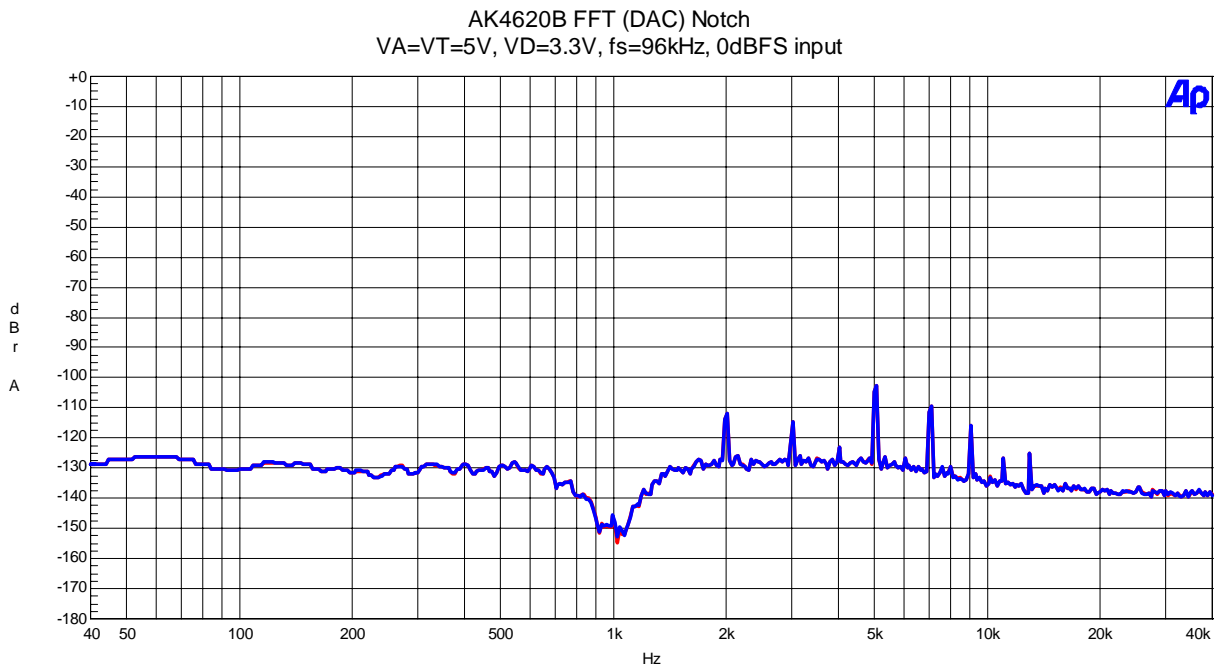

Figure 69. FFT (fin=1kHz, Input Level=0dBFS, Notch Filter)

(fs=96kHz)

AK4620B FFT (DAC)
VA=VT=5V, VD=3.3V, fs=96kHz, -60dBFS input

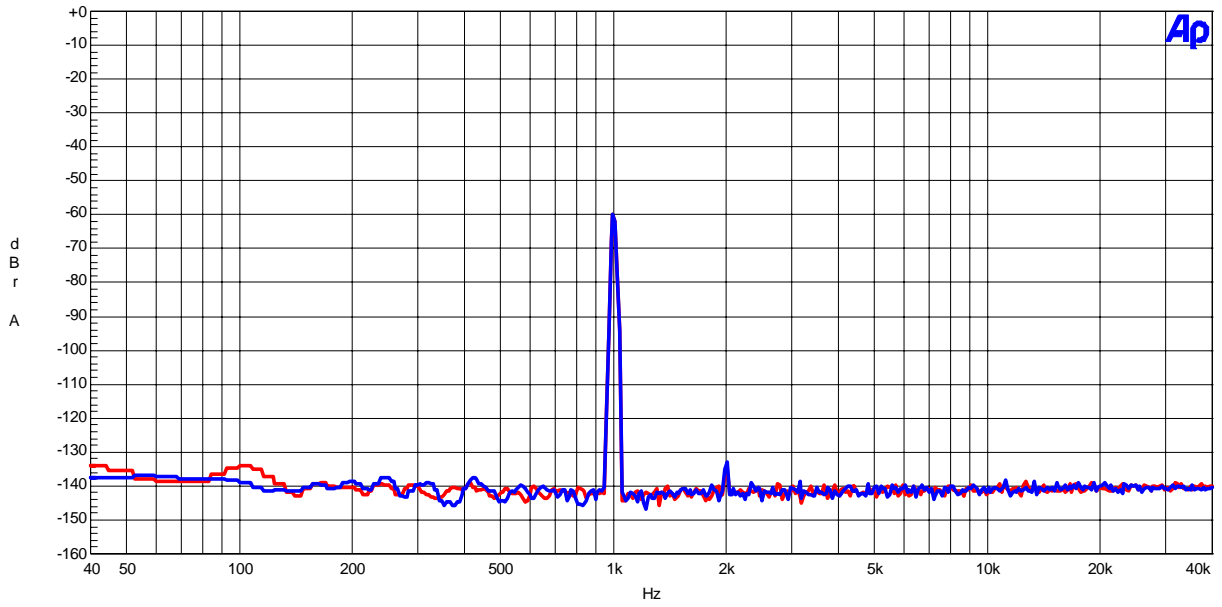

Figure 70. FFT (fin=1kHz, Input Level=-60dBFS)

AK4620B FFT (DAC)
VA=VT=5V, VD=3.3V, fs=96kHz, No input

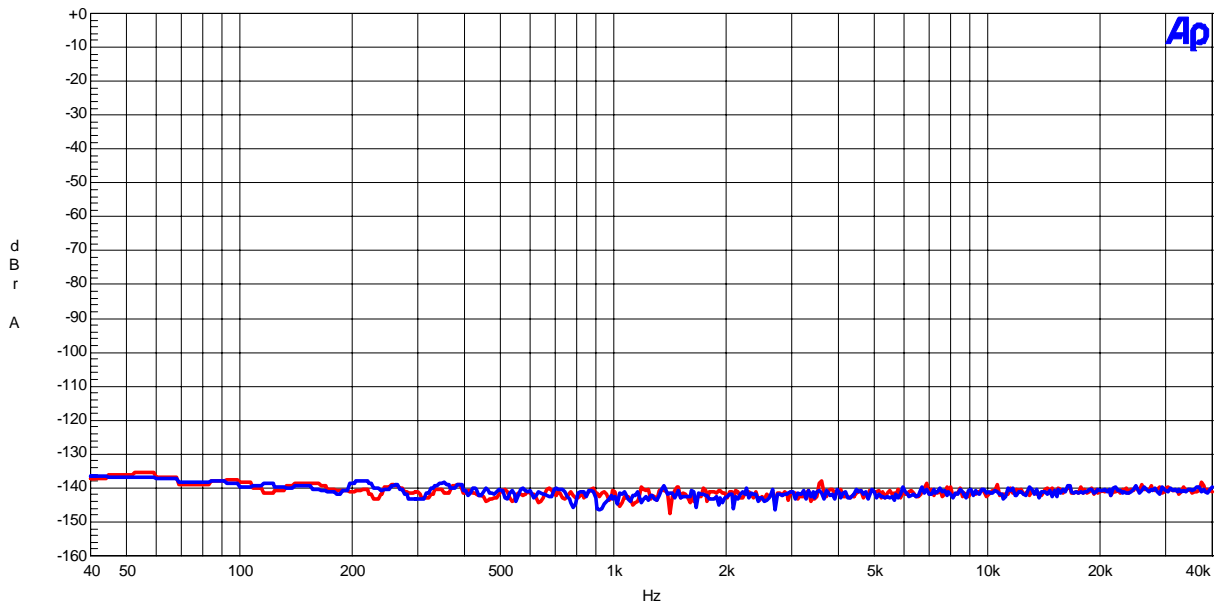

Figure 71. FFT (Noise Floor)

(fs=96kHz)

AK4620B THD+N vs Input Level
VA=VT=5V, VD=3.3V, fs=96kHz

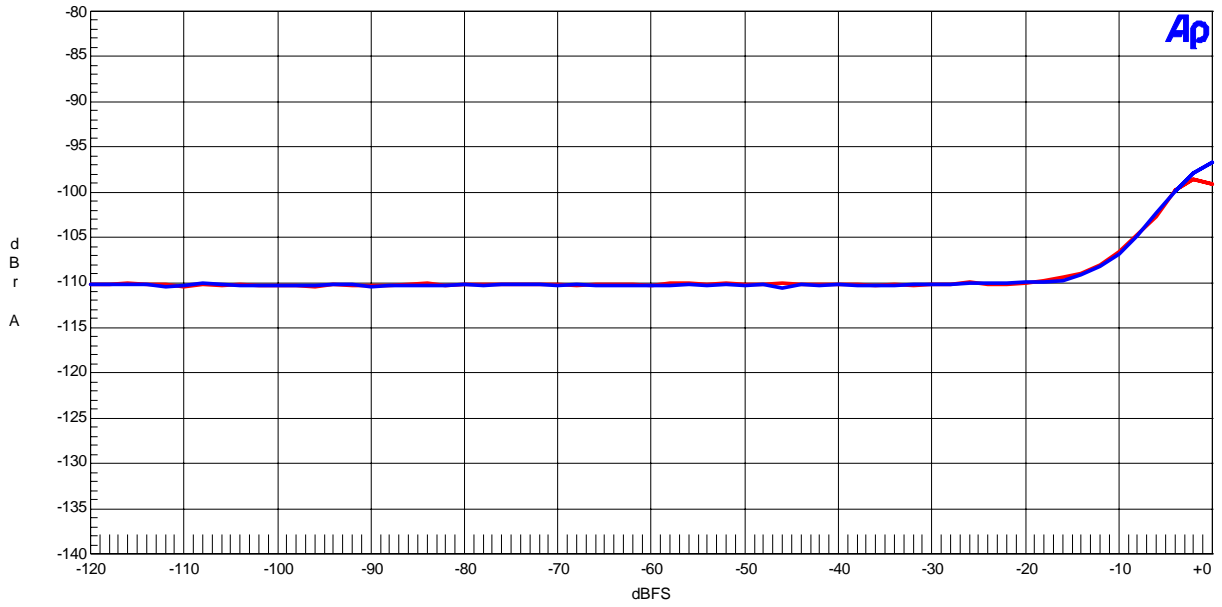

Figure 72. THD +N vs. Input level (fin=1kHz)

AK4620B THD+N vs Input Frequency
VA=VT=5V, VD=3.3V, fs=96kHz

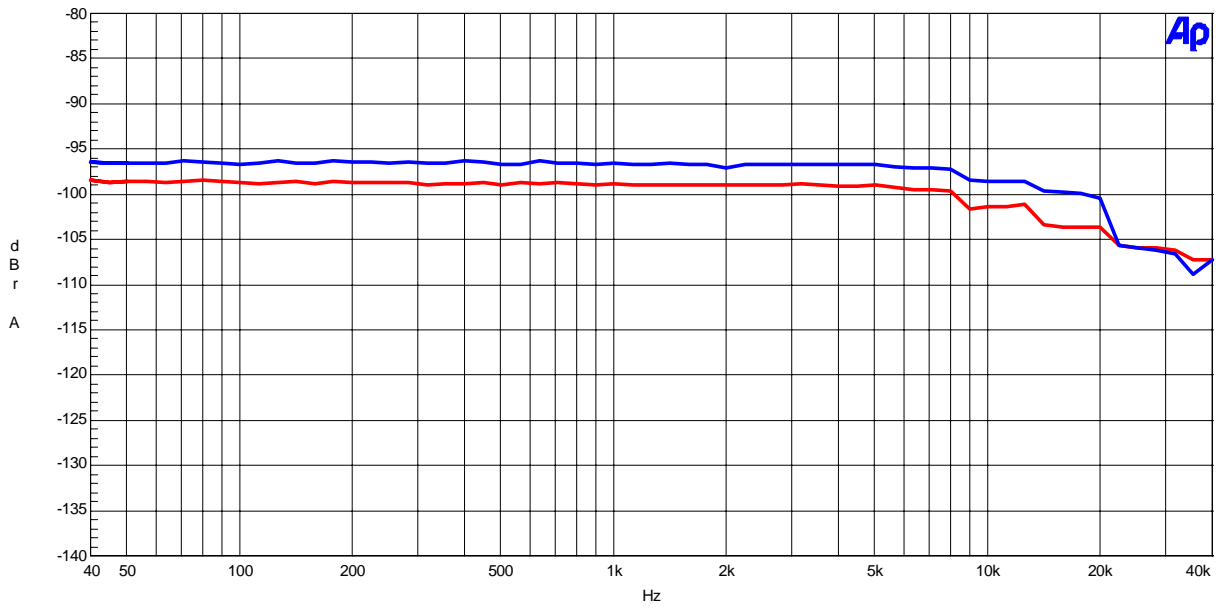

Figure 73. THD +N vs. Input Frequency (Input level=0dBFS)

(fs=96kHz)

AK4620B Linearity
VA=VT=5V, VD=3.3V, fs=96kHz

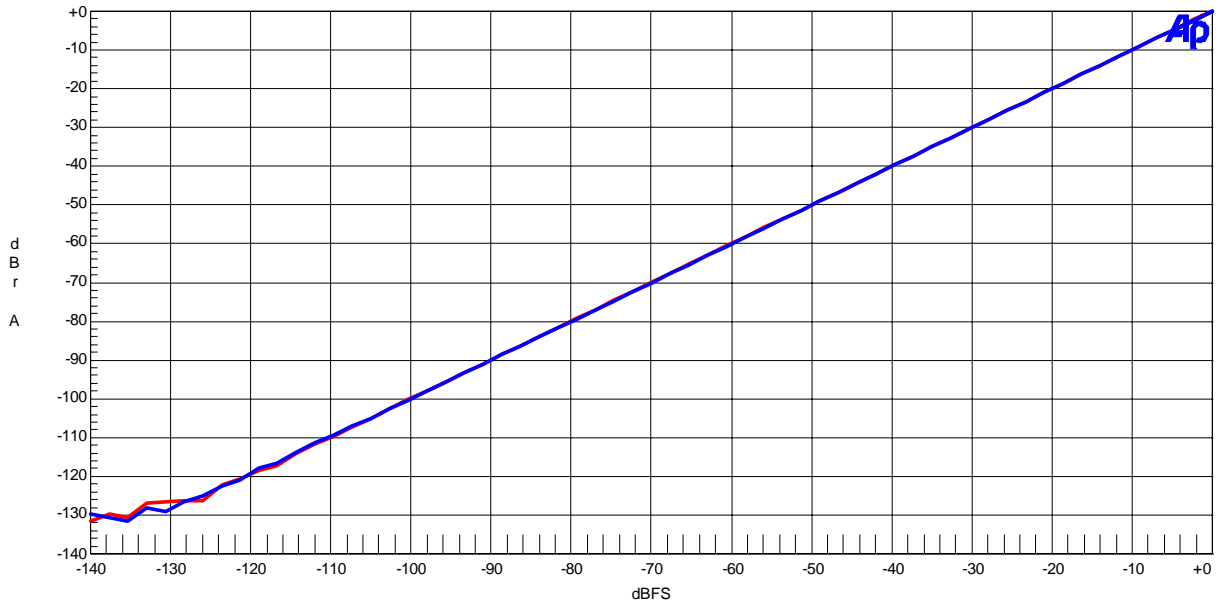

Figure 74. Linearity (fin=1kHz)

AK4620B Frequency Respons
VA=VT=5V, VD=3.3V, fs=96kHz

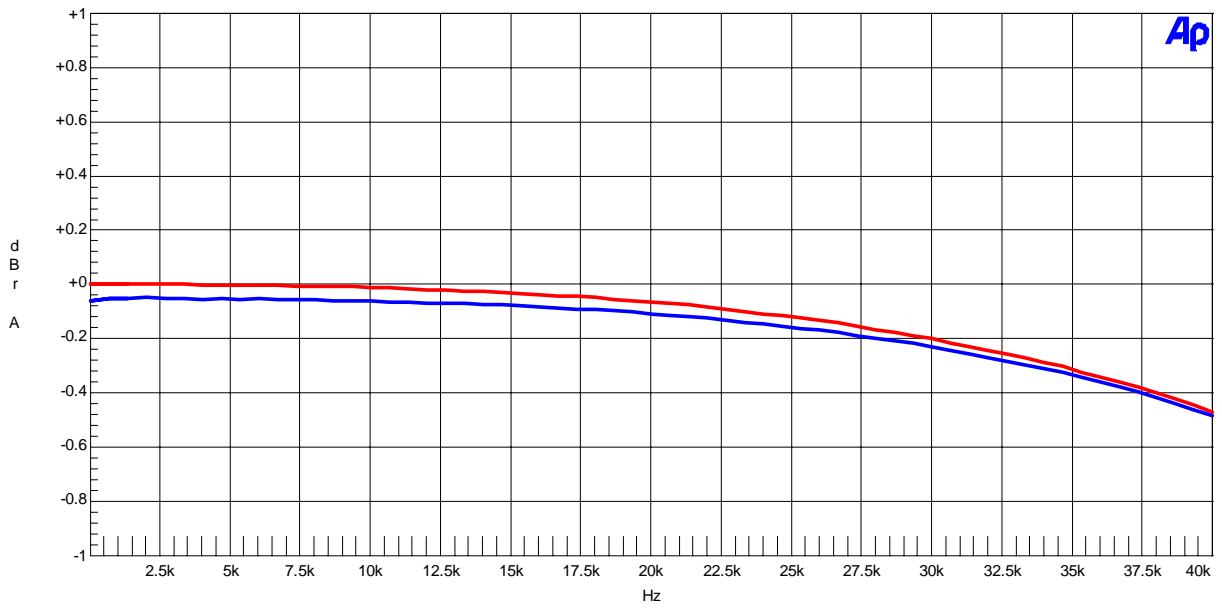

Figure 75. Frequency Response (Input level=0dBFS)

(fs=96kHz)

AK4620B Crosstalk Lch: Red, Rch: Blue
VA=VT=5V, VD=3.3V, fs=96kHz

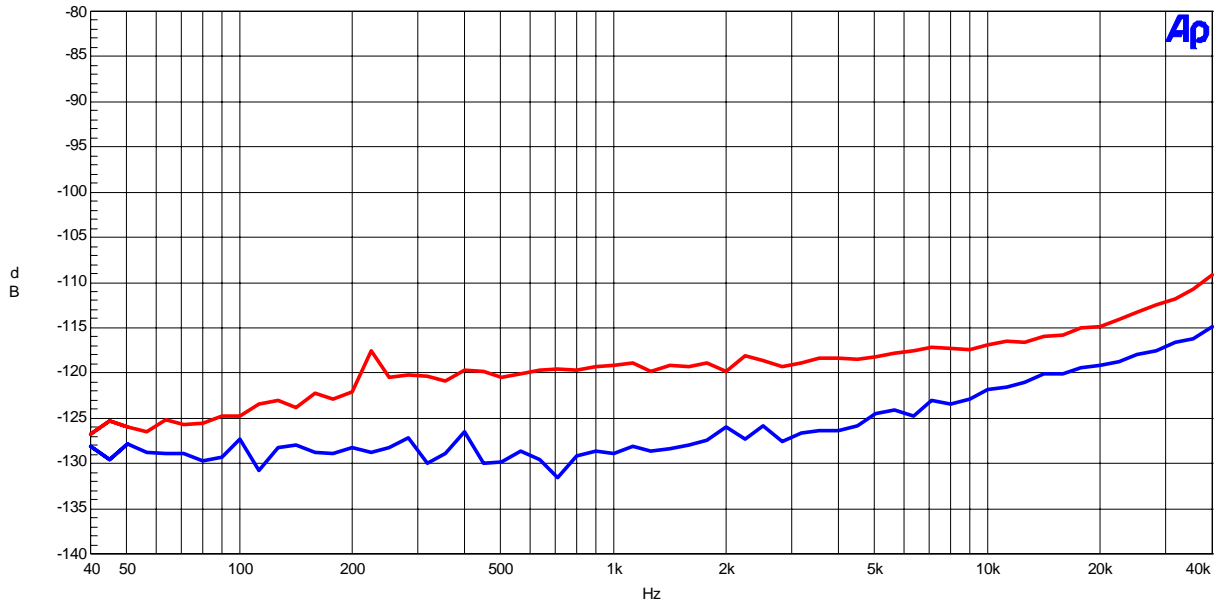

Figure 76. Crosstalk

(fs=192kHz)

AKM

AK4620 FFT (DAC)
VA=VT=5V, VD=3.3V, fs=192kHz, 0dBFS input

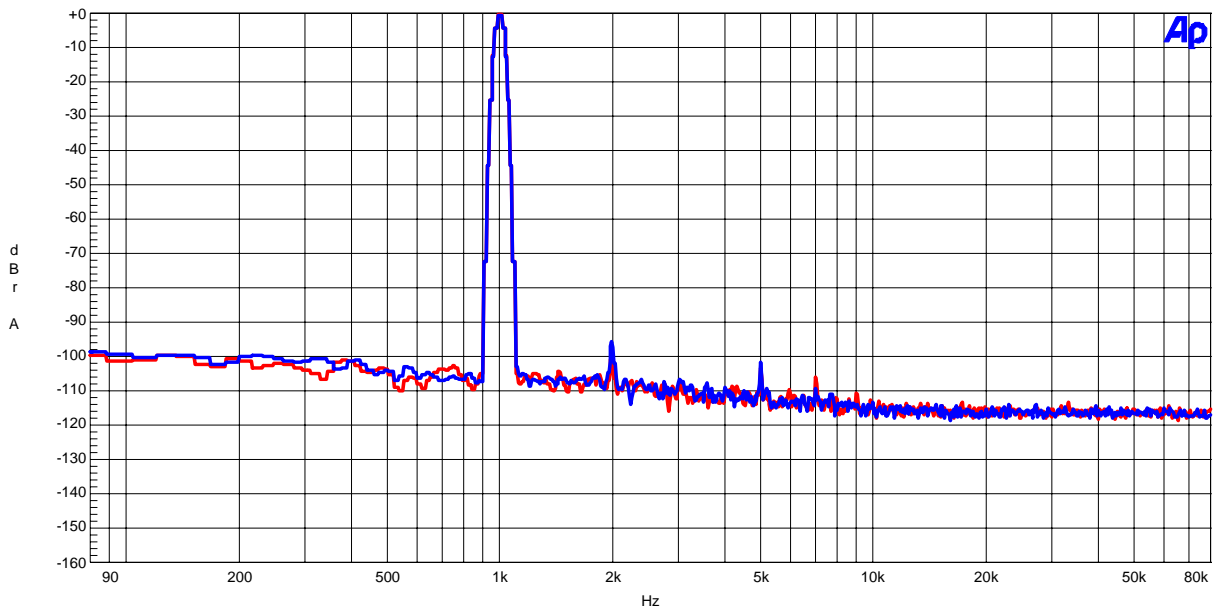

Figure 77. FFT (fin=1kHz, Input Level=0dBFS)

AKM

AK4620 FFT (DAC) Notch
VA=VT=5V, VD=3.3V, fs=192kHz

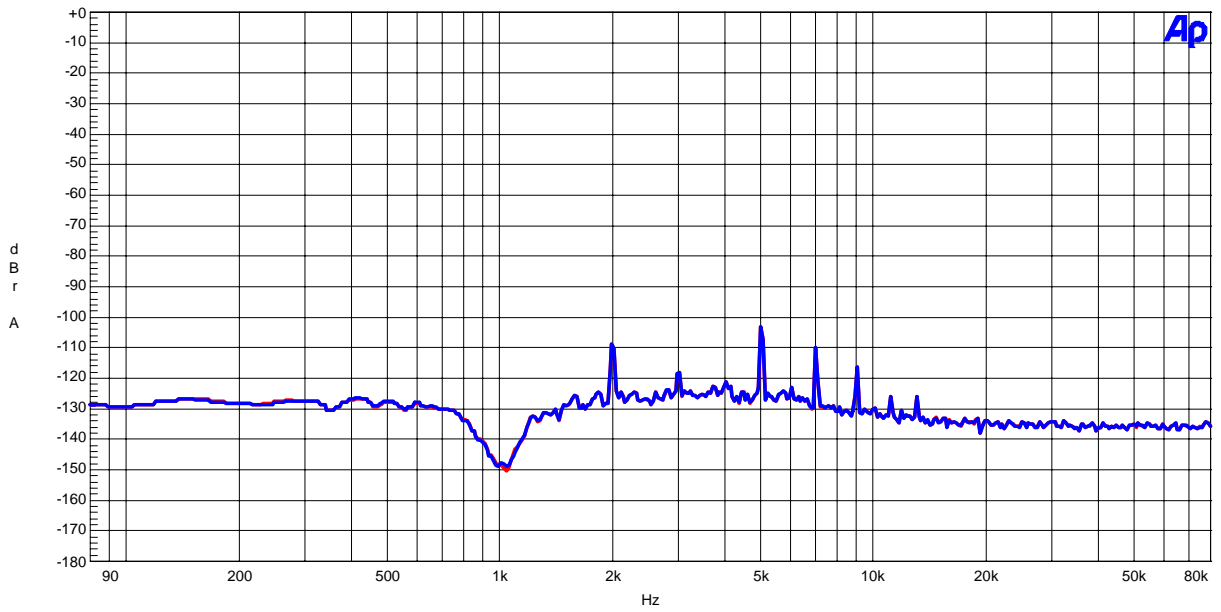

Figure 78. FFT (fin=1kHz, Input Level=0dBFS, Notch Filter)

(fs=192kHz)

AKM

AK4620 FFT (DAC)
VA=VT=5V, VD=3.3V, fs=192kHz, -60dBFS input

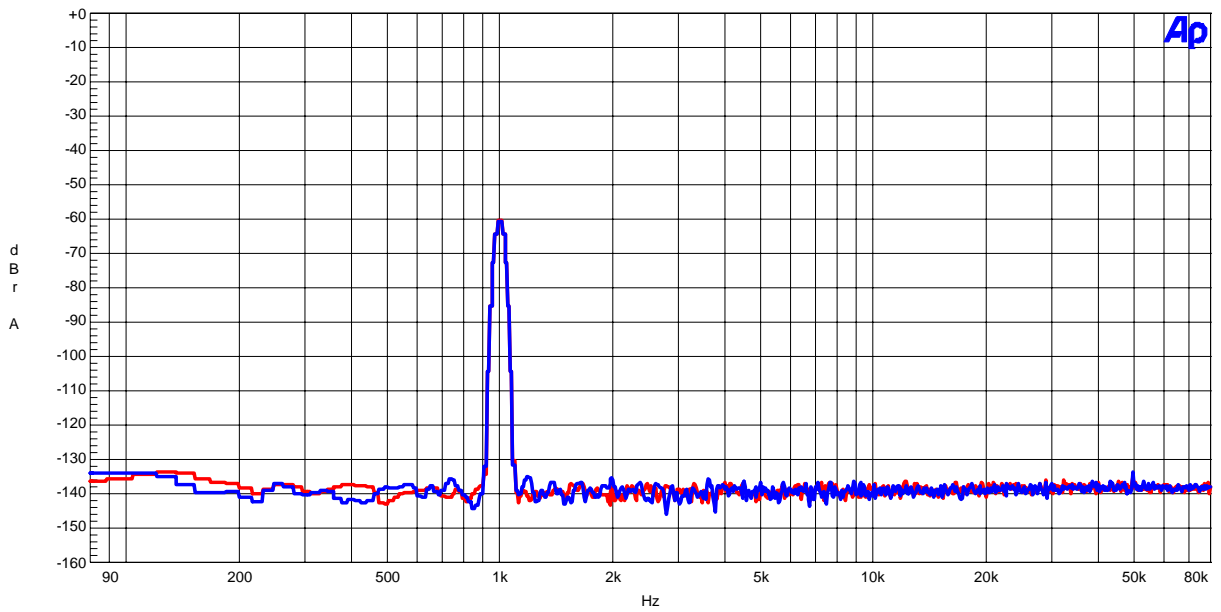

Figure 79. FFT (fin=1kHz, Input Level=-60dBFS)

AKM

AK4620 FFT (DAC)
VA=VT=5V, VD=3.3V, fs=192kHz, No input

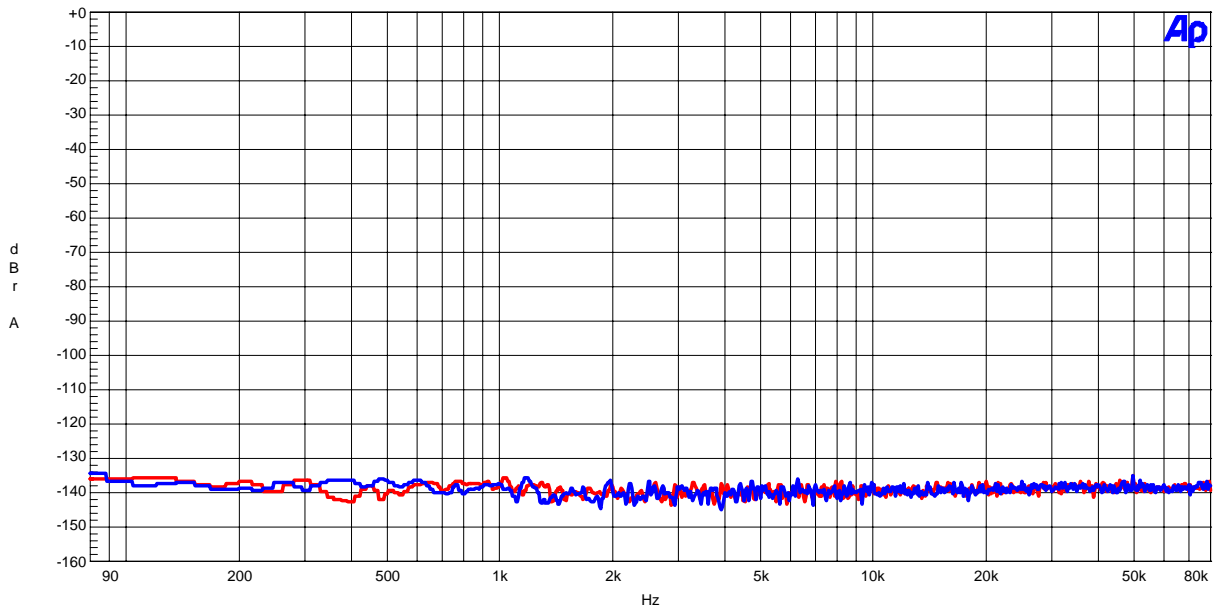

Figure 80. FFT (Noise Floor)

(fs=192kHz)

AKM

AK4620 THD+N vs Input Level
VA=VT=5V, VD=3.3V, fs=192kHz

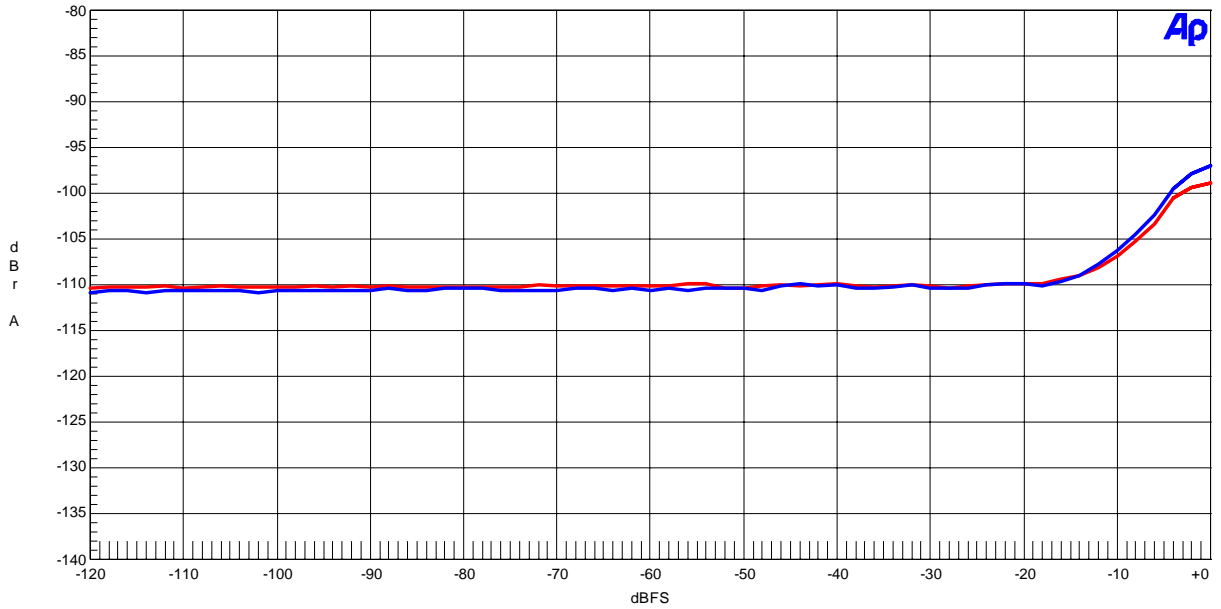

Figure 81. THD+N vs. Input level (fin=1kHz)

AKM

AK4620 THD+N vs Input Frequency
VA=VT=5V, VD=3.3V, fs=192kHz

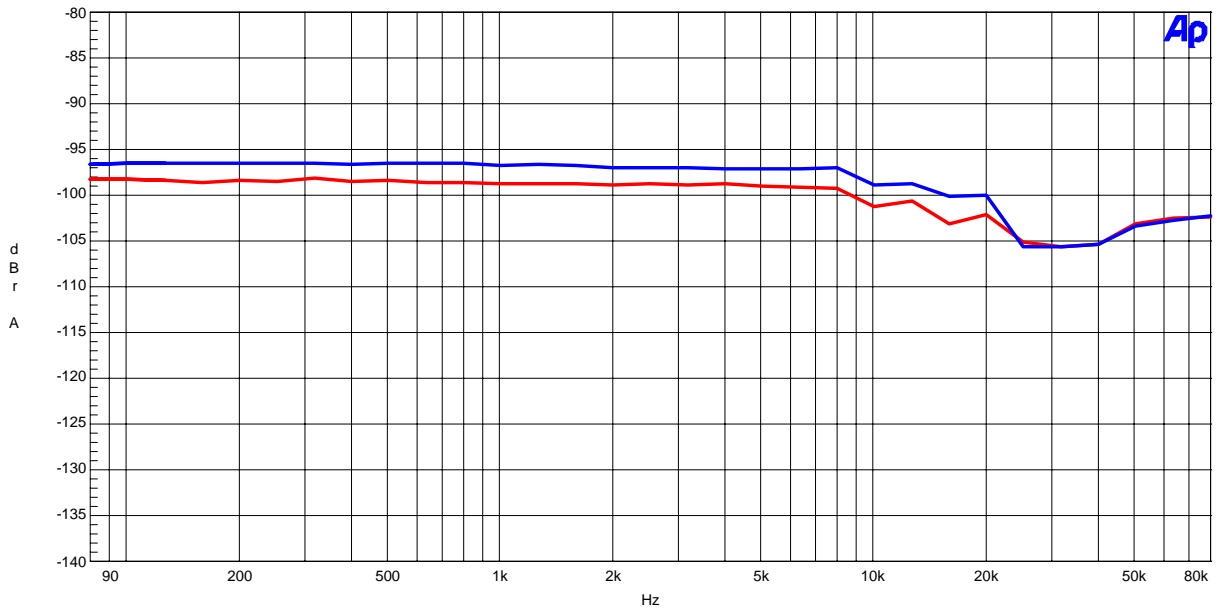

Figure 82. THD+N vs. Input Frequency (Input level=0dBFS)

(fs=192kHz)

AKM

AK4620 Linearity
VA=VT=5V, VD=3.3V, fs=192kHz

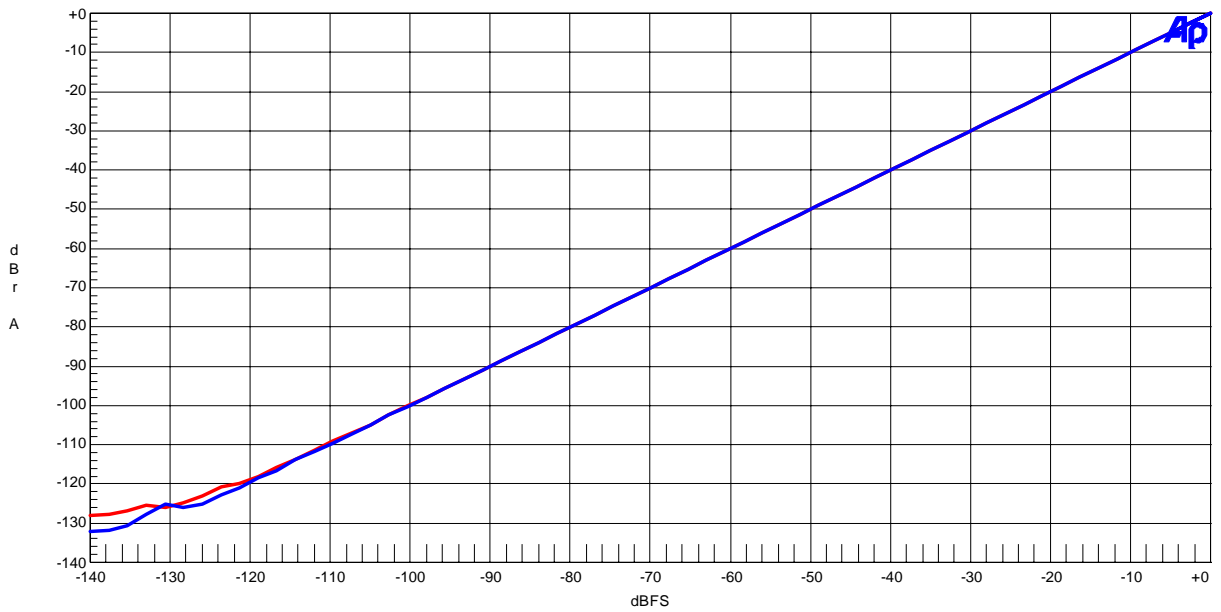

Figure 83. Linearity (fin=1kHz)

AKM

AK4620 Frequency Respons
VA=VT=5V, VD=3.3V, fs=192kHz

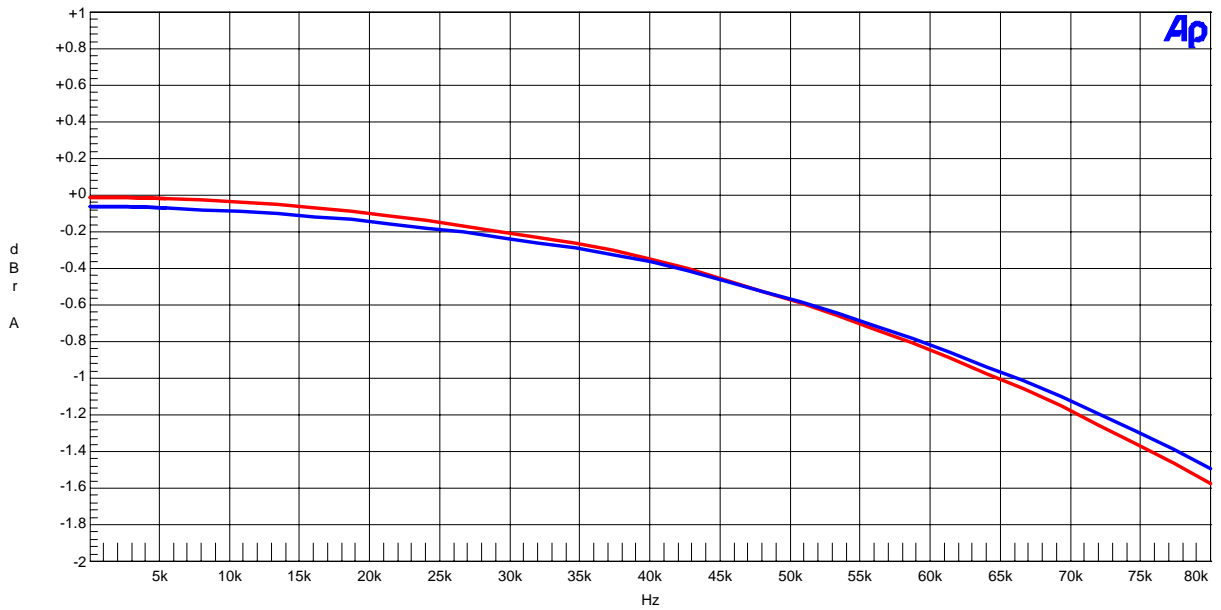

Figure 84. Frequency Response (Input level=0dBFS)

(fs=192kHz)

AKM

AK4620 Crosstalk Lch: Red, Rch: Blue
VA=VT=5V, VD=3.3V, fs=192kHz

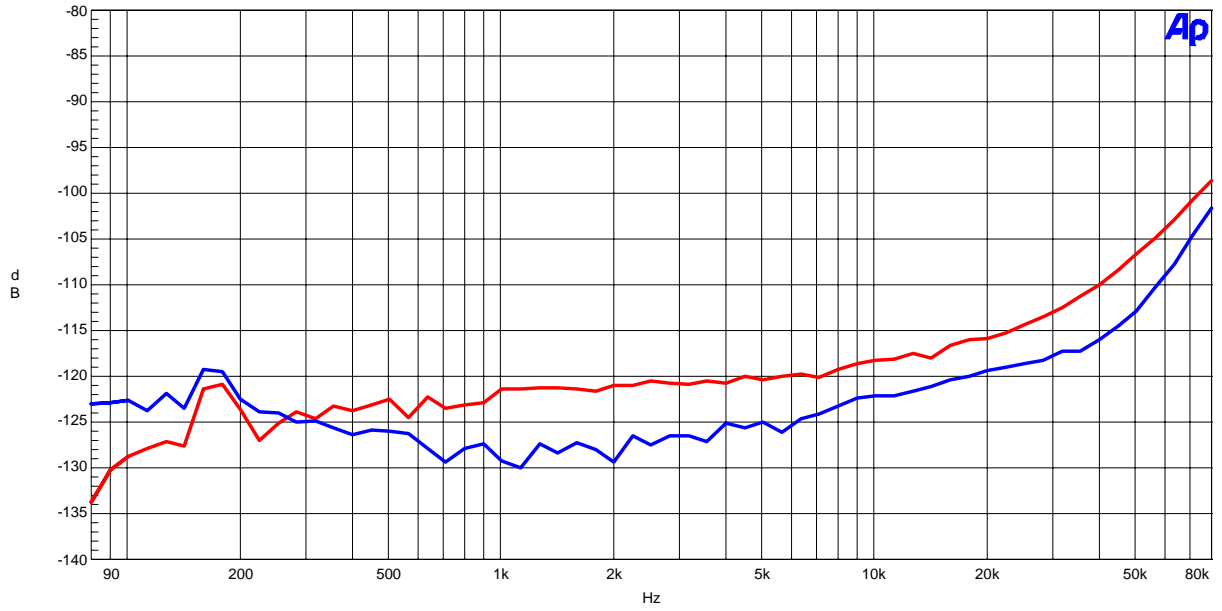

Figure 85. Crosstalk

Revision History

Date (YY/MM/DD)	Manual Revision	Board Revision	Reason	Contents
05/05/26	KM078900	0	First Edition	
06/06/12	KM078901	1	Change control software	Control software was updated: 1.0 → 2.0 Control software manual was changed: P12-14 → P12-19
			Error Correct	Circuit diagram was changed. <ul style="list-style-type: none"> • U1: AK4620A →AK4620B • Document Number: AK4620A →AK4620B • Circuit diagram name: AKD4620A-B → AKD4620B-B

IMPORTANT NOTICE

- These products and their specifications are subject to change without notice. Before considering any use or application, consult the Asahi Kasei Microsystems Co., Ltd. (AKM) sales office or authorized distributor concerning their current status.
- AKM assumes no liability for infringement of any patent, intellectual property, or other right in the application or use of any information contained herein.
- Any export of these products, or devices or systems containing them, may require an export license or other official approval under the law and regulations of the country of export pertaining to customs and tariffs, currency exchange, or strategic materials.
- AKM products are neither intended nor authorized for use as critical components in any safety, life support, or other hazard related device or system, and AKM assumes no responsibility relating to any such use, except with the express written consent of the Representative Director of AKM. As used here:
 - (a) A hazard related device or system is one designed or intended for life support or maintenance of safety or for applications in medicine, aerospace, nuclear energy, or other fields, in which its failure to function or perform may reasonably be expected to result in loss of life or in significant injury or damage to person or property.
 - (b) A critical component is one whose failure to function or perform may reasonably be expected to result, whether directly or indirectly, in the loss of the safety or effectiveness of the device or system containing it, and which must therefore meet very high standards of performance and reliability.
- It is the responsibility of the buyer or distributor of an AKM product who distributes, disposes of, or otherwise places the product with a third party to notify that party in advance of the above content and conditions, and the buyer or distributor agrees to assume any and all responsibility and liability for and hold AKM harmless from any and all claims arising from the use of said product in the absence of such notification.

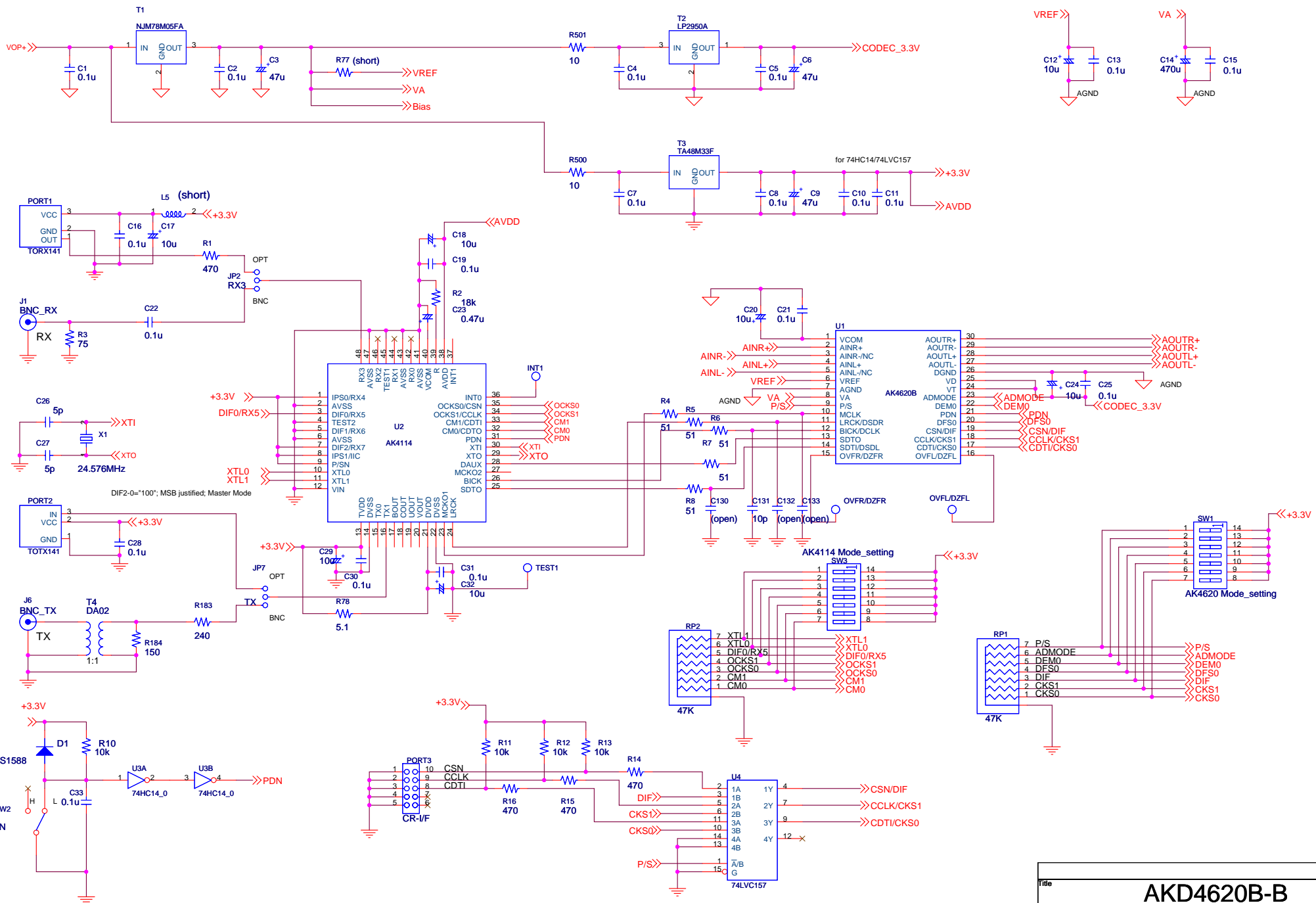

Title	AKD4620B-B	
Size	Document Number	Rev
A3	AK4620B	1
Date:	Monday, June 12, 2006	Sheet 1 of 2

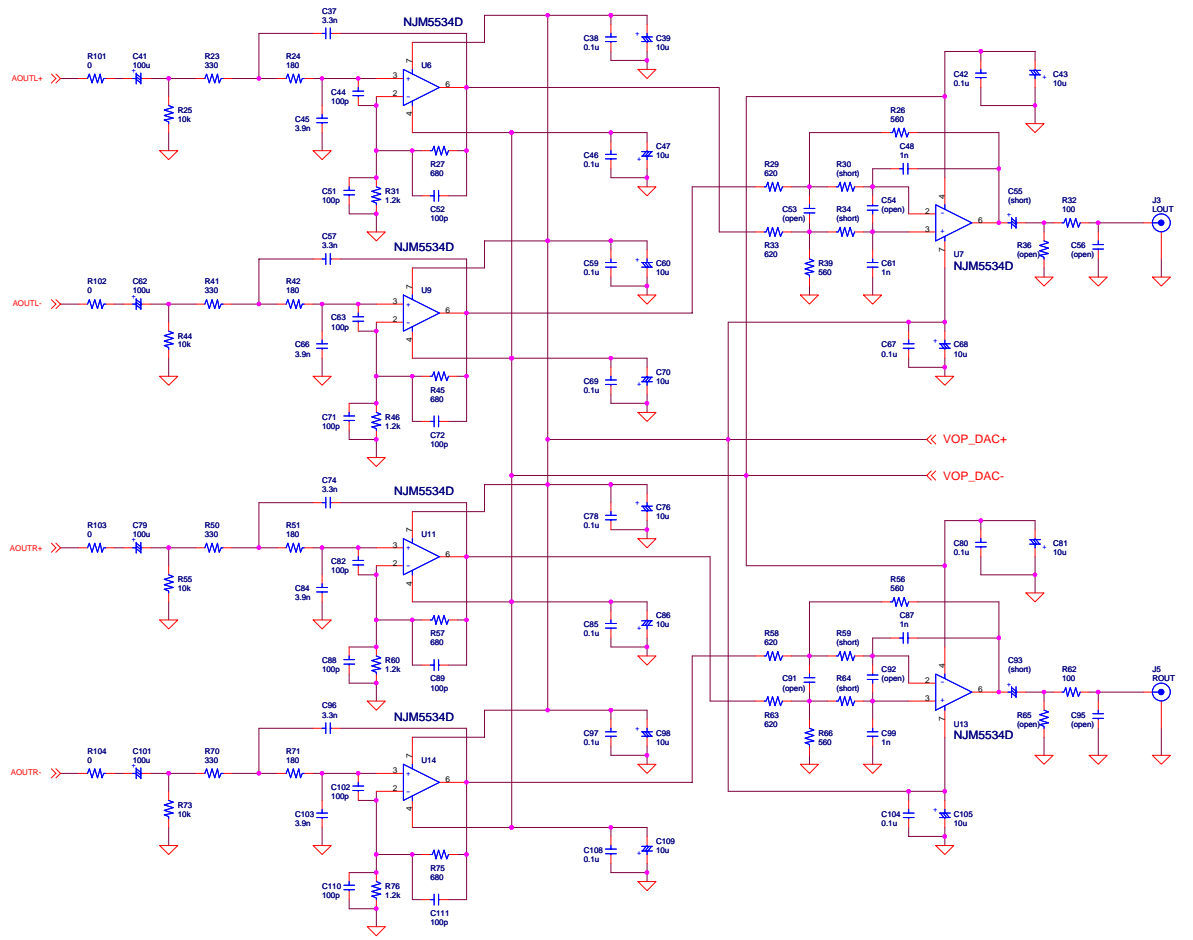
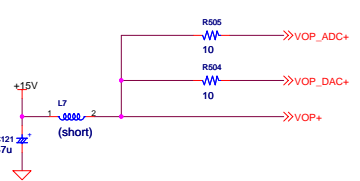
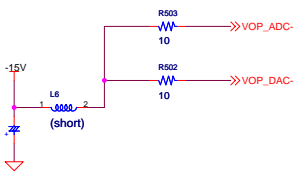
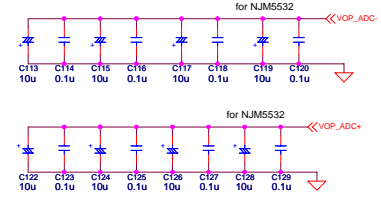
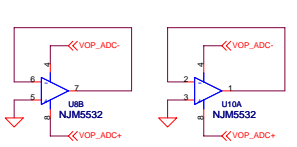
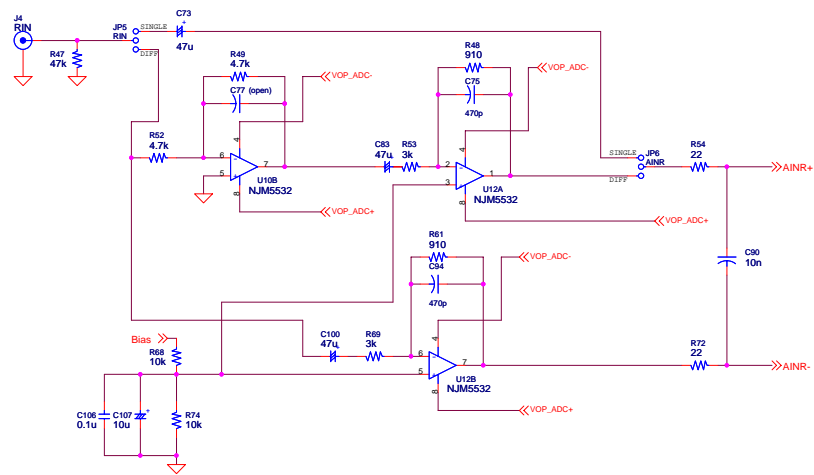
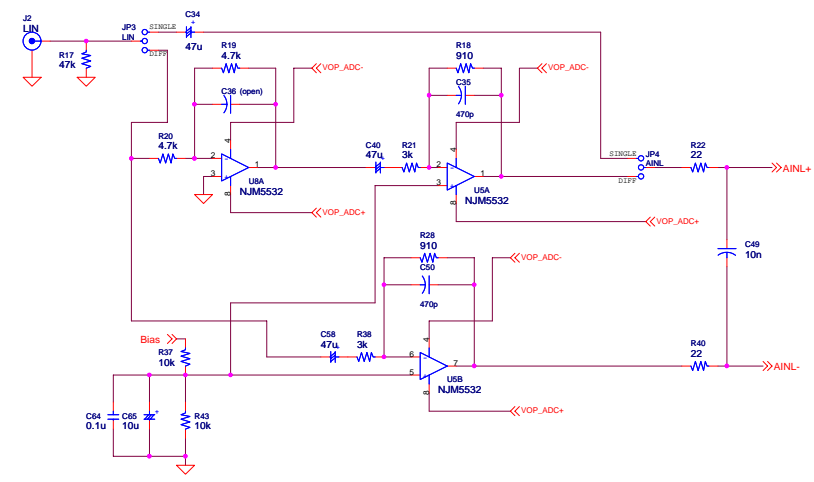

File		AKD4620B-B	
Size	A2	Document Number	Analog_I/O
Rev	1	Sheet	2 of 2
Date:	Monday, June 12, 2006		