

NPN EPITAXIAL PLANAR TRANSISTOR

 Lead(Pb)-Free

Description

The WTM1624 applies to voltage regulators, relay drivers, lamp drivers, and electrical equipment.

1. BASE
2. COLLECTOR
3. EMITTER

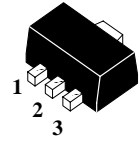

SOT-89

Features

- Adoption of FBET, MBIT processes
- Low collector-to-emitter saturation voltage
- Fast switching speed
- Large current capacity and wide ASO

Absolute Maximum Ratings at $T_A = 25^\circ\text{C}$

Parameter	Symbol	Ratings	Unit
Junction Temperature	T_j	+150	$^\circ\text{C}$
Storage Temperature	T_{stg}	-55~+150	$^\circ\text{C}$
Collector to Base Voltage	V_{CBO}	60	V
Collector to Emitter Voltage	V_{CEO}	50	V
Emitter to Base Voltage	V_{EBO}	6	V
Collector Current (DC)	I_C	3	A
Collector Current (Pulse) (Note1)	I_{CP}	6	A
Total Power Dissipation	P_D	0.5	W

Note 1: Single pulse, $PW=10\text{ms}$

Electrical Characteristics ($T_A = 25^\circ\text{C}$, unless otherwise stated)

Symbol	Min.	Typ.	Max.	Unit	Test Conditions
V_{CBO}	60	-	-	V	$I_C=10\mu\text{A}$, $I_E=0$
V_{CEO}	50	-	-	V	$I_C=1\text{mA}$, $I_B=0$
V_{EBO}	6	-	-	V	$I_E=10\mu\text{A}$, $I_C=0$
I_{CBO}	-	-	1	μA	$V_{CB}=40\text{V}$, $I_E=0$
I_{EBO}	-	-	1	μA	$V_{EB}=4\text{V}$, $I_C=0$
* $V_{CE(sat)}$	-	0.19	0.5	V	$I_C=2\text{A}$, $I_B=100\text{mA}$
* $V_{BE(sat)}$	-	0.94	1.2	V	$I_C=2\text{A}$, $I_B=100\text{mA}$
* h_{FE}	100	-	560		$V_{CE}=2\text{V}$, $I_C=100\text{mA}$
f_T	-	150	-	MHz	$V_{CE}=10\text{V}$, $I_C=50\text{mA}$
C_{ob}	-	25	-	pF	$V_{CB}=10\text{V}$, $I_E=0$, $f=1\text{MHz}$
t_{stg}	-	650	-	ns	See test circuit
t_f	-	35	-	ns	

*Measured under pulse condition. Pulse width $\leq 380\mu\text{s}$, Duty Cycle $\leq 2\%$

Classification of h_{FE}

Rank	R	S	T	U
Range	100 - 200	140 - 280	200 - 400	280 - 560

Test Circuit(Unit: resistance: Ω , capacitance: F)

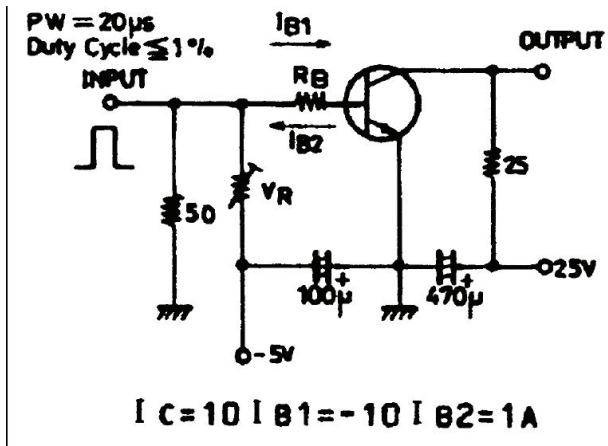

Characteristics Curve

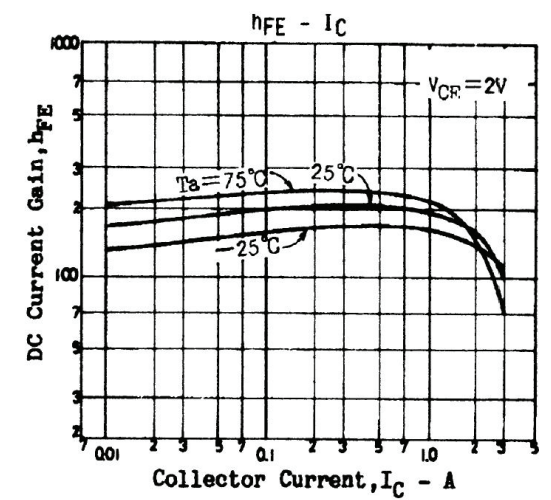
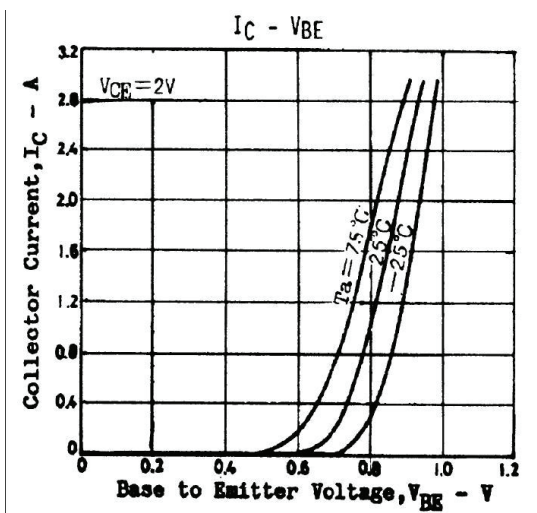
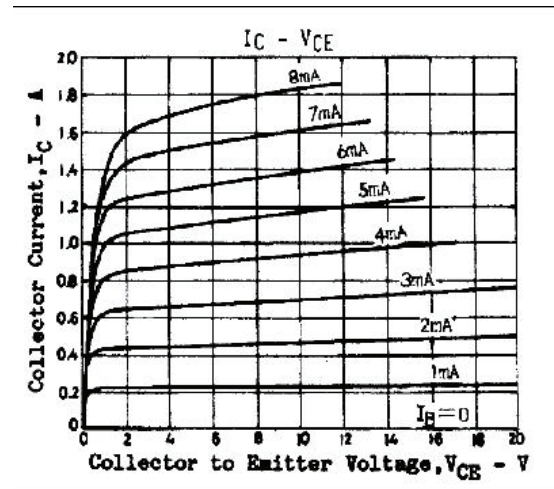
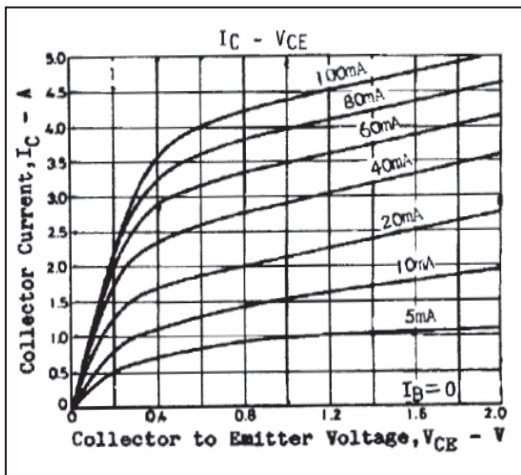

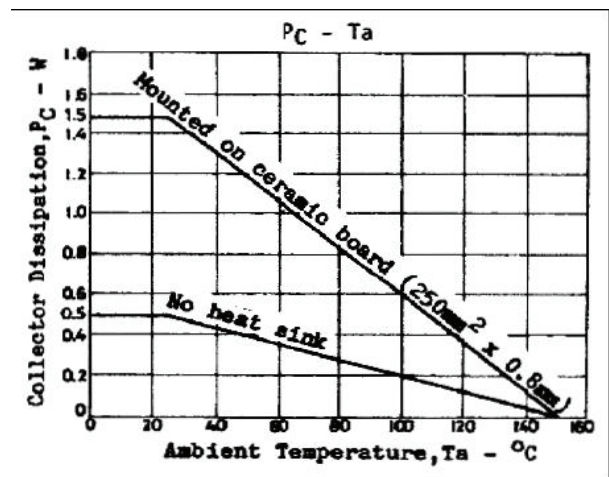
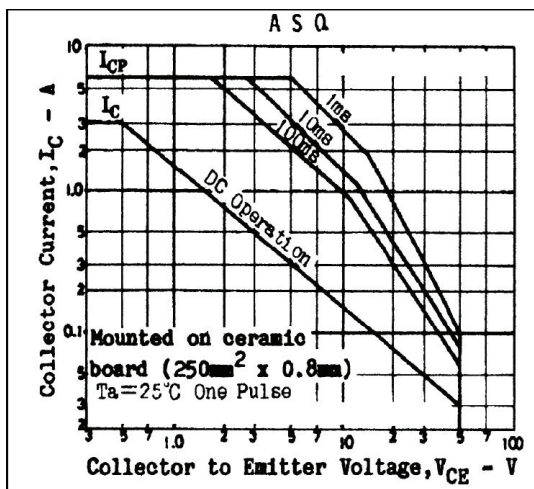
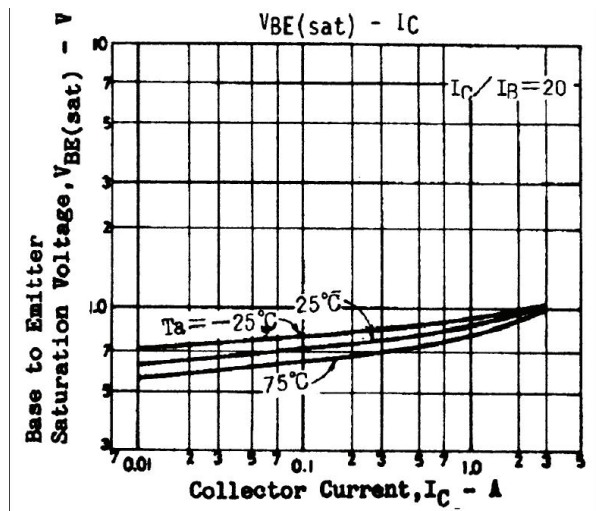
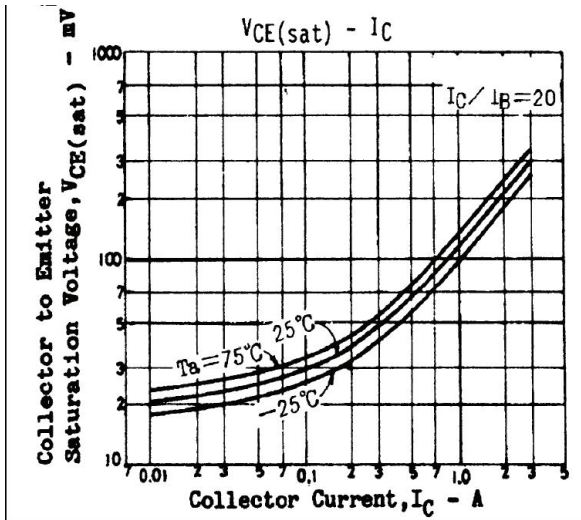
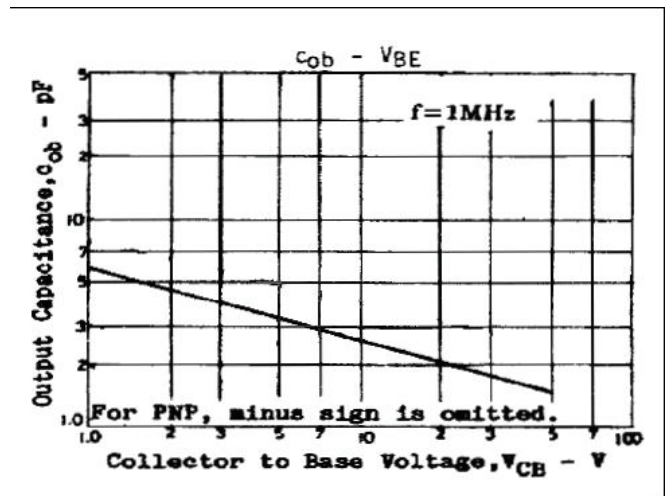
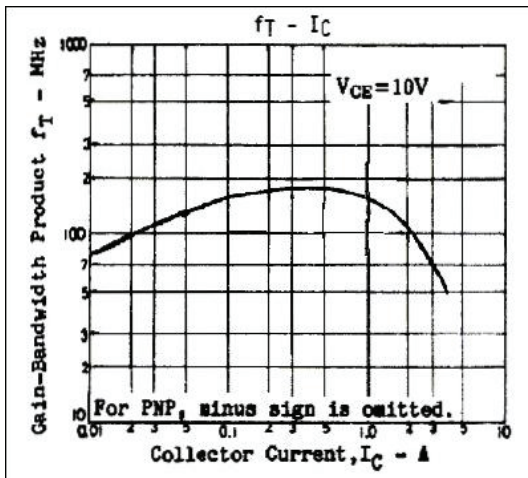

SOT-89 Outline Dimensions

unit:mm

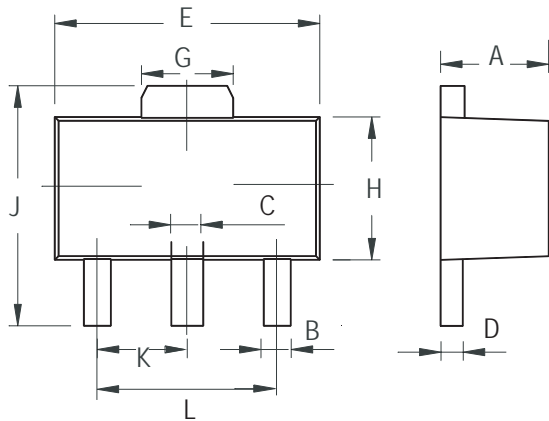

SOT-89		
Dim	Min	Max
A	1.400	1.600
B	0.320	0.520
C	0.360	0.560
D	0.350	0.440
E	4.400	4.600
G	1.400	1.800
H	2.300	2.600
J	3.940	4.250
K	1.500TYP	
L	2.900	3.100