

General-purpose Basic Switch











X









Direct Current Switch with Built-in Magnetic Blowout

- Incorporates a small permanent magnet in the contact mechanism to deflect the arc to effectively extinguish it.
- Ideal for switching DC circuits
- Wide variety of actuators for a wide scope of applications
- Same shape and mounting procedures as Omron's Model Z snap action switches.



Ordering Information

Terminal		Solder terminal 	Screw terminal 
Actuator		Model	Model
Pin plunger		X-10G	X-10G-B
Slim spring plunger		X-10GS	X-10GS-B
Short spring plunger		X-10GD	X-10GD-B
Panel mount plunger		X-10GQ	X-10GQ-B
Panel mount roller plunger		X-10GQ22	X-10GQ22-B
Panel mount cross roller plunger		X-10GQ21	X-10GQ21-B
Leaf spring		X-10GL	X-10GL-B
Short hinge lever		X-10GW21	X-10GW21-B

Terminal		Solder terminal 	Screw terminal 
Actuator		Model	Model
Hinge lever		X-10GW	X-10GW-B
Low-force hinge lever		X-10GW4	X-10GW4-B
Short hinge roller lever		X-10GW22	X-10GW22-B
Hinge roller lever		X-10GW2	X-10GW2-B
Reverse hinge lever		X-10GM	X-10GM-B
Reverse short hinge roller lever *		X-10GM22	X-10GM22-B
Reverse hinge roller lever *		X-10GM2	X-10GM2-B

* The plungers of reverse-type models are continuously pressed by the compression coil springs and the plungers are freed by operating the levers.

Model Number Legend

X - 10 G -
 1 2 3 4

1. Ratings
 10: 10 A (125 VDC)

2. Contact Gap
 G: 0.9 mm

3. Actuator
 None: Pin plunger
 D: Short spring plunger
 S: Slim spring plunger
 Q: Panel mount plunger
 Q21: Panel mount cross roller plunger
 Q22: Panel mount roller plunger
 L: Leaf spring
 W: Hinge lever
 W2: Hinge roller lever
 W21: Short hinge lever
 W22: Short hinge roller lever
 W4: Low-force hinge lever
 M: Reverse hinge lever
 M2: Reverse hinge roller lever
 M22: Reverse short hinge roller lever

4. Terminals
 None: Solder terminal
 B: Screw terminal
 (with toothed washer)

Specifications

■ Characteristics

Operating speed		0.1 mm to 1 m/s (See note 1)
Operating frequency	Mechanical	240 operations/min
	Electrical	20 operations/min
Contact resistance		15 mΩ max. (initial value)
Insulation resistance		100 MΩ min. (at 500 VDC)
Dielectric strength		1,500 VAC, 50/60 Hz for 1 min between terminals of the same polarity, between current-carrying metal parts and the ground, and between each terminal and non-current-carrying metal parts
Vibration resistance	Malfunction	10 to 55 Hz, 1.5-mm double amplitude (See note 2)
Shock resistance	Destruction	1,000 m/s ² max.
	Malfunction	300 m/s ² max. (See notes 1 and 2)
Degree of protection		IP00
Degree of protection against electric shock		Class I
Proof tracking index (PTI)		175
Ambient operating temperature		-25°C to 80°C (with no icing)
Ambient operating humidity		35% to 85%RH
Service life	Mechanical	1,000,000 operations min.
	Electrical	100,000 operations min.
Weight		Approx. 27 to 63 g

- Note: 1. The values are for the pin plunger models.
 2. Malfunction: 1 ms max.

■ Ratings

Rated voltage	Non-inductive load (A)				Inductive load (A)			
	Resistive load		Lamp load		Inductive load		Motor load	
	NC	NO	NC	NO	NC	NO	NC	NO
8 VDC	10		3	1.5	10	10	5	2.5
14 VDC	10		3	1.5	10	10	5	2.5
30 VDC	10		3	1.5	10	10	5	2.5
125 VDC	10		3	1.5	7.5	6	5	2.5
250 VDC	3		1.5	0.75	2	1.5	2	1.5

- Note: 1. The above values are for the steady-state current.
 2. Inductive load has a power factor of 0.4 min. (AC) and a time constant of 7 ms max. (DC).
 3. Lamp load has an inrush current of 10 times the steady-state current.
 4. Motor load has an inrush current of 6 times the steady-state current.
 5. The above electrical ratings also apply to the AC voltage.
 6. With the reverse-type models (X-10GM□), the normally closed circuits and normally open circuits are reversed.
 7. The ratings values apply under the following test conditions:
 (1) Ambient temperature: 20±2°C
 (2) Ambient humidity: 65±5%RH
 (3) Operating frequency: 20 operations/min

■ Contact Specification

Contacts	Material	Silver
	Gap (standard value)	0.9 mm
Inrush current	NC	30 A max.
	NO	15 A max.

■ Safety Standards Ratings

UL/CSA

Rated voltage	X-10G
125 VDC	10 A
250 VDC	3 A

EN (CE) (Conform to EN61058-1)

Rated voltage	X-10
125 VDC	10 A

Engineering Data

Mechanical Durability (X-10G)

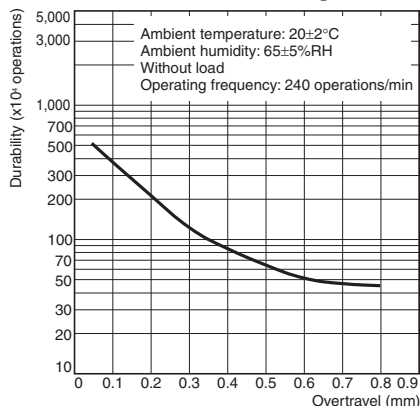

Electrical Durability (X-10G)

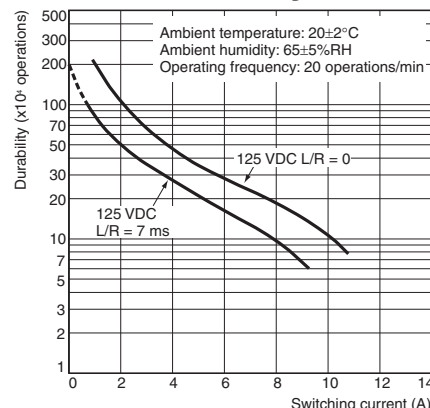

Structure

Contact Form (SPDT)

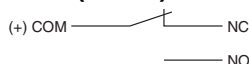

Note: With the reverse-type models (X-10GM□), the NC and NO terminal arrangements are reversed.

Dimensions

Note: Unless otherwise specified, all units are in millimeters and a tolerance of ± 0.4 mm applies to all dimensions.

Terminals

Screw Terminals (-B)

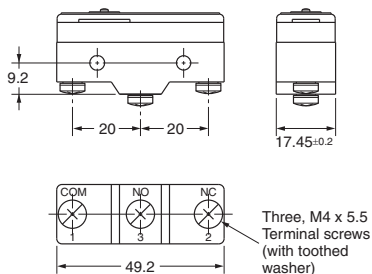

- Note:** 1. Appropriate terminal screw tightening torque: 0.78 to 1.18 N·m.
- 2. In case of DC voltage, set the COM to the positive terminal.

Solder Terminal (Blank)

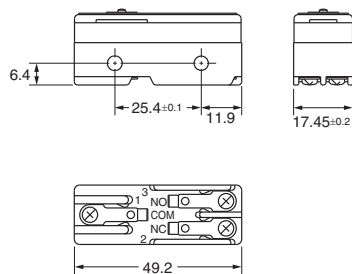

Mounting

All switches can be mounted using M4 mounting screws with plane washers or spring washers to securely mount the Switch. Tighten the screws to a torque of 1.18 to 1.47 N·m.

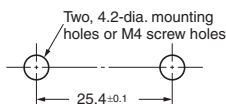

Versions with panel mount plungers can be panel mounted via the plunger, provided that the hexagonal nut of the actuator is tightened to a torque of 2.94 to 4.9 N·m.

Panel Mount Plunger	Panel Mount Roller Plunger
<p>12.5^{+0.2} dia.</p>	<p>12.5^{+0.2} dia. 5^{+0.2} dia.</p>

Note: Mount using either the side mounting holes or the panel mount plunger, not both. If using the side mounting holes, then remove the hexagonal nut(s) from the panel mount plunger.

Accessories (Terminal Covers, Actuators, and Separators): Refer to 'Z/A/X/DZ Common Accessories' datasheet

Note: 1. All drawings show the switches with screw terminals. For solder terminals, remove the “-B” from the end of the part number
 2. Unless otherwise specified, all units are in millimeters and a tolerance of ± 0.4 mm applies to all dimensions.

Pin Plunger
X-10G-B

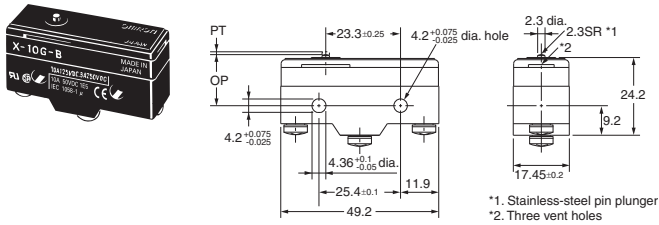

Slim Spring Plunger
X-10GS-B

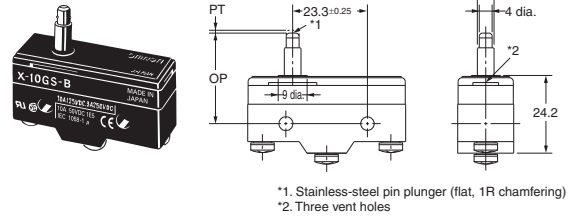

Short Spring Plunger
X-10GD-B

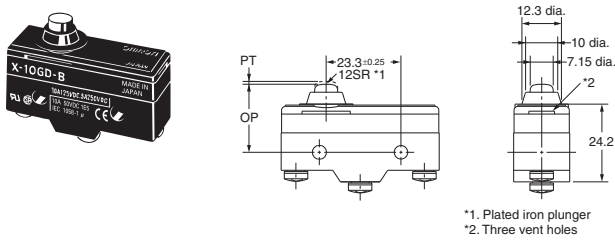

Panel Mount Plunger
X-10GQ-B

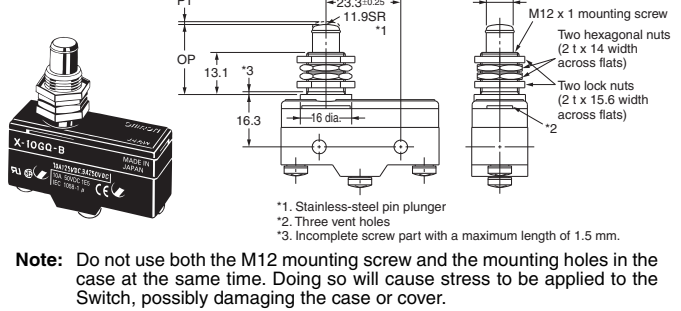

Panel Mount Roller Plunger
X-10GQ22-B

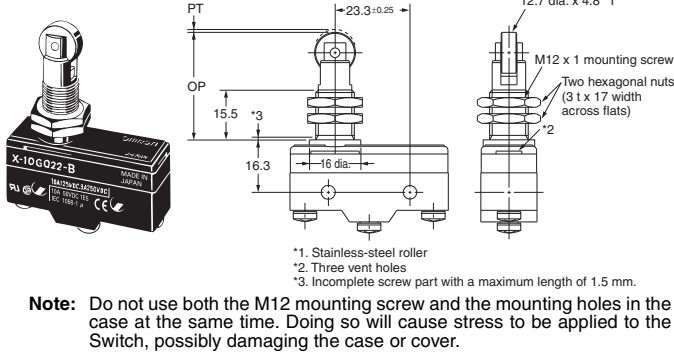

Panel Mount Cross Roller Plunger
X-10GQ21-B

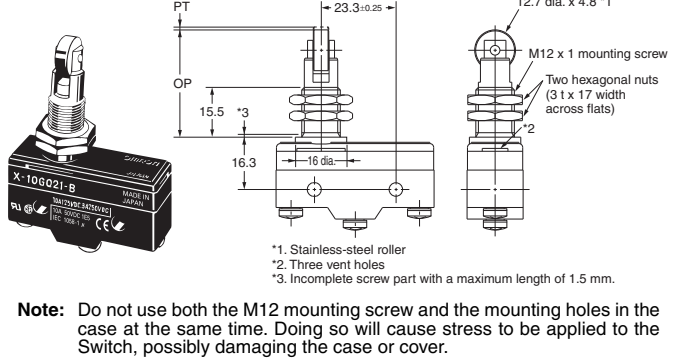

Leaf Spring
X-10GL-B

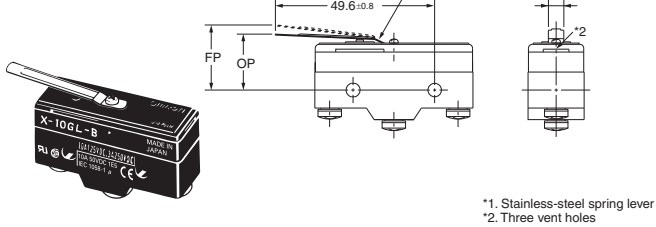

Operating Characteristics	X-10G-B	X-10GS-B	X-10GD-B	X-10GQ-B	X-10GQ22-B	X-10GQ21-B	X-10GL-B
OF max.	510 gf	510 gf	510 gf	510 gf	510 gf	510 gf	200 gf
RF min.	114 gf	114 gf	114 gf	114 gf	114 gf	114 gf	14 gf
PT max.	0.9 mm	0.9 mm	0.9 mm	0.9 mm	0.9 mm	0.9 mm	-
OT min.	0.13 mm	1.6 mm	1.6 mm	5.5 mm	3.6 mm	3.6 mm	1.6 mm *
MD max.	0.18 mm	0.18 mm	0.18 mm	0.18 mm	0.18 mm	0.18 mm	2.3 mm
FP max.	-	-	-	-	-	-	22.1 mm
OP	15.9±0.4 mm	28.2±0.5 mm	21.2±0.5 mm	21.8±0.8 mm	33.4±1.2 mm	33.4±1.2 mm	17.4±0.8 mm

* Be sure to use the switch at the rated OT value of 1.6 mm.

Note: 1. All drawings show the switches with screw terminals. For solder terminals, remove the “-B” from the end of the part number
 2. Unless otherwise specified, all units are in millimeters and a tolerance of ± 0.4 mm applies to all dimensions.

Short Hinge Lever

X-10GW21-B

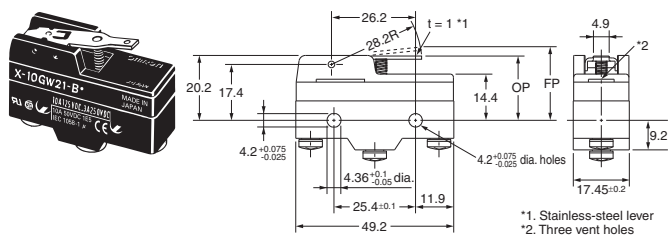

Hinge Lever

X-10GW-B

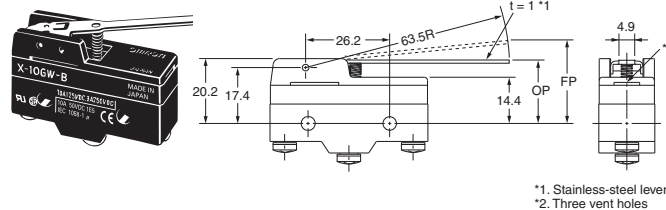

Low-force Hinge Lever

X-10GW4-B

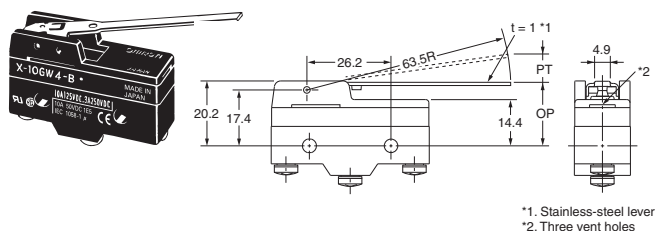

Short Hinge Roller Lever

X-10GW22-B

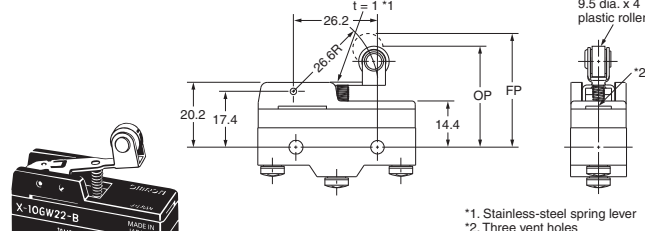

Hinge Roller Lever

X-10GW2-B

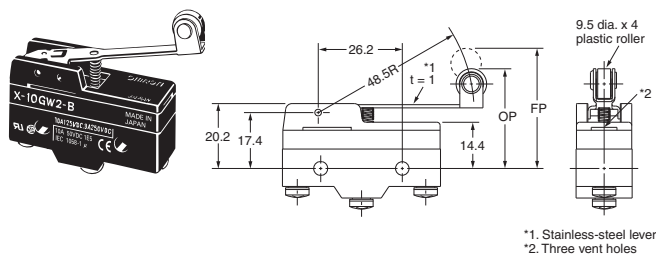

Reverse Hinge Lever

X-10GM-B

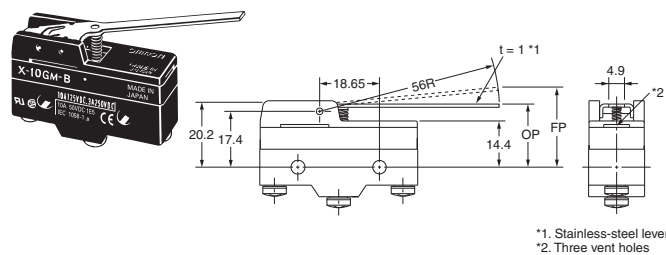

Reverse Short Hinge Lever

X-10GM22-B

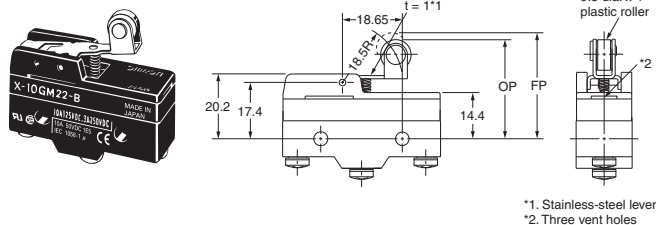

Reverse Hinge Roller Lever

X-10GM2-B

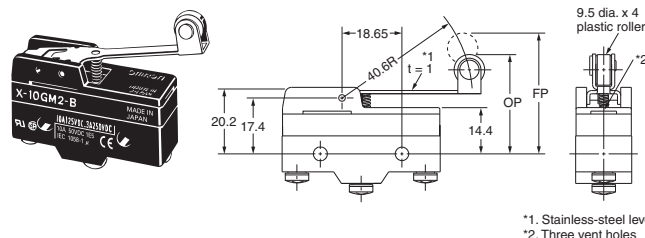

Operating Characteristics	X-10GW21-B	X-10GW-B	X-10GW4-B	X-10GW22-B	X-10GW2-B	X-10GM-B	X-10GM22-B	X-10GM2-B
OF max.	250 gf	110 gf	25 gf	220 gf	145 gf	220 gf	700 gf	320 gf
RF min.	32 gf	14 gf	5 gf	35 gf	21 gf	25 gf	155 gf	50 gf
PT max.	-	-	14.3 mm	-	-	-	-	-
OT min.	2.1 mm	4.8 mm	4.8 mm	2.4 mm	4 mm	5.5 mm	2 mm	4 mm
MD max.	1.7 mm	3.9 mm	3.9 mm	1.7 mm	3 mm	2.1 mm	0.75 mm	1.5 mm
FP max.	25.5 mm	34.6 mm	-	37.1 mm	40.5 mm	26.8 mm	36.1 mm	37.4 mm
OP	20.7±0.8 mm	21.1±0.8 mm	21.1±0.8 mm	32.2±0.8 mm	32.2±0.8 mm	21.1±0.8 mm	32.2±0.8 mm	32.2±0.8 mm

Safety Precautions

Be sure to read the precautions and information common to all Snap Action and Detection Switches, contained in the Technical User's Guide, "Snap Action Switches, Technical Information" for correct use.

Precautions for Safe Use

Terminal Connection

When soldering lead wires to the Switch, make sure that the capacity of the soldering iron is 60 W maximum. Do not take more than 5 s to solder any part of the Switch. The characteristics of the Switch will deteriorate if a soldering iron with a capacity of more than 60 W is applied to any part of the Switch for 5 s or more.

Operation

- Make sure that the switching frequency or speed is within the specified range.

1. If the switching speed is extremely slow, the contact may not be switched smoothly, which may result in a contact failure or contact welding.
2. If the switching speed is extremely fast, switching shock may damage the Switch soon. If the switching frequency is too high, the contact may not catch up with the speed.

The rated permissible switching speed and frequency indicate the switching reliability of the Switch.

The life of a Switch is determined at the specified switching speed. The life varies with the switching speed and frequency even when they are within the permissible ranges. In order to determine the life of a Switch model to be applied to a particular use, it is best to conduct an appropriate durability test on some samples of the model under actual conditions.

- Make sure that the actuator travel does not exceed the permissible OT position. The operating stroke must be set to 70% to 100% of the rated OT.

Precautions for Correct Use

Mounting Location

- Do not use the switch alone in atmospheres such as flammable or explosive gases. Arcing and heat generation associated with switching may cause fires or explosions.
- Switches are generally not constructed with resistance against water. Use a protective cover to prevent direct spraying if the switch is used in locations subject to splashing or spurting oil or water, dust adhering.

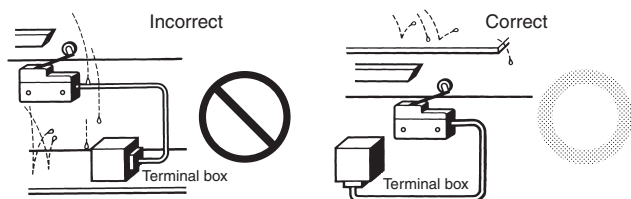

- Install the switch in a location that is not directly subject to debris and dust from cutting. The actuator and the switch body must be protected from accumulated cutting debris and dirt.

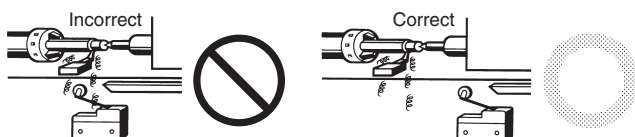

- Do not use the switch in locations subject to hot water (greater than 60°C) or in water vapor.
- Do not use the switch outside the specified temperature and atmospheric conditions. The permissible ambient temperature depends on the model. (Refer to the specifications in this catalog.) Sudden thermal changes may cause thermal shock to distort the switch and result in faults.

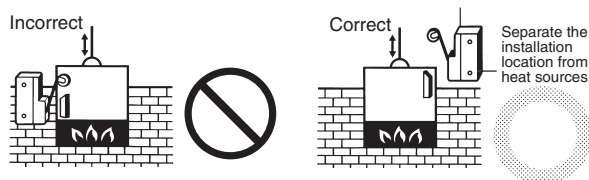

- Mount a cover if the switch is to be installed in a location where worker inattention could result in incorrect operation or accidents.



- Subjecting the switch to continuous vibration or shock may result in contact failure, faulty operation or reduced service life due to abrasion powder. Excessive vibration or shock will cause the contacts to operate malfunction or become damaged. Mount the switch in a location that is not subject to vibration or shock and in a direction that does not subject the switch to resonance.
- If silver contacts are used with relatively low frequency for a long time or are used with microloads, the sulfide coating produced on the contact surface will not be broken down and contact faults will result. Use a microload switch that uses gold contacts.
- Do not use the switch in atmospheres with high humidity or heat or in harmful gases, such as sulfide gas (H₂S, SO₂), ammonia gas (NH₃), nitric acid gas (HNO₃), or chlorine gas (Cl₂). Doing so may impair functionality, such as with damage due to contacting faults or corrosion.
- The switch includes contacts. If the switch is used in an atmosphere with silicon gas, arc energy may cause silicon oxide (SiO₂) to accumulate on the contacts and result in contact failure. If there is silicon oil, silicon filling, silicon wiring, or other silicon products in the vicinity of the switch, use a contact protection circuit to limit arcing and remove the source of the silicon gas.

Handling

- Set the common (COM) terminal to the positive terminal. If it is set to the negative terminal, the Switch will not turn OFF.
- When using the Switch under an inductive load, the arc suppression capability varies depending on current. If the current becomes 0.6 to 1.2 A or if the time constant L/R exceeds 7 ms, be sure to provide an arc suppressor.
- Since the Switch incorporates a permanent magnet, attention must be paid to the following points:
 - (a) Avoid mounting the Switch directly onto a magnetic substance.
 - (b) Do not subject the Switch to severe shocks.
 - (c) Avoid placing the Switch in a strong magnetic field.
 - (d) Be sure to prevent iron dust or iron chips from adhering to the built-in magnet or the magnetic blowout function of the Switch will be adversely affected.
 - (e) Do not apply thermal shock to the Switch, or the magnetic flux will be diminished.
- Since a ventilation hole is provided to avoid abnormal corrosion due to operating conditions, provide a dustproofing device in locations where the Switch is exposed to dust.
- Do not change operating positions for the actuator. Changing the position may cause malfunction.

Panel-mounted Model (X-10G□)

- To side-mount the panel-mount Switch to the panel with screws, remove the hexagonal nut from the actuator.
- Too large a dog angle and too fast operating speed may damage the Switch when the Switch is side-mounted on the panel.
- Too fast operating speed and too long overtravel of the roller plunger Switch may result in damage to the Switch.

Omron Electronic Components, LLC

Terms and Conditions of Sales

I. GENERAL

- Definitions:** The words used herein are defined as follows.
 - Terms:** These terms and conditions
 - Seller:** Omron Electronic Components LLC and its subsidiaries
 - Buyer:** The buyer of Products, including any end user in section III through VI
 - Products:** Products and/or services of Seller
 - Including:** Including without limitation
- Offer; Acceptance:** These Terms are deemed part of all quotations, acknowledgments, invoices, purchase orders and other documents, whether electronic or in writing, relating to the sale of Products by Seller. Seller hereby objects to any Terms proposed in Buyer's purchase order or other documents which are inconsistent with, or in addition to, these Terms.
- Distributor:** Any distributor shall inform its customer of the contents after and including section III of these Terms.

II. SALES

- Prices; Payment:** All prices stated are current, subject to change without notice by Seller. Buyer agrees to pay the price in effect at the time the purchase order is accepted by Seller. Payments for Products received are due net 30 days unless otherwise stated in the invoice. Buyer shall have no right to set off any amounts against the amount owing in respect of this invoice.
- Discounts:** Cash discounts, if any, will apply only on the net amount of invoices sent to Buyer after deducting transportation charges, taxes and duties, and will be allowed only if (a) the invoice is paid according to Seller's payment terms and (b) Buyer has no past due amounts owing to Seller.
- Interest:** Seller, at its option, may charge Buyer 1.5% interest per month or the maximum legal rate, whichever is less, on any balance not paid within the stated terms.
- Orders:** Seller will accept no order less than 200 U.S. dollars net billing.
- Currencies:** If the prices quoted herein are in a currency other than U.S. dollars, Buyer shall make remittance to Seller at the then current exchange rate most favorable to Seller; provided that if remittance is not made when due, Buyer will convert the amount to U.S. dollars at the then current exchange rate most favorable to Seller available during the period between the due date and the date remittance is actually made.
- Governmental Approvals:** Buyer shall be responsible for all costs involved in obtaining any government approvals regarding the importation or sale of the Products.
- Taxes:** All taxes, duties and other governmental charges (other than general real property and income taxes), including any interest or penalties thereon, imposed directly or indirectly on Seller or required to be collected directly or indirectly by Seller for the manufacture, production, sale, delivery, importation, consumption or use of the Products sold hereunder (including customs duties and sales, excise, use, turnover and license taxes) shall be charged to and remitted by Buyer to Seller.
- Financial:** If the financial position of Buyer at any time becomes unsatisfactory to Seller, Seller reserves the right to stop shipments or require satisfactory security or payment in advance. If Buyer fails to make payment or otherwise comply with these Terms or any related agreement, Seller may (without liability and in addition to other remedies) cancel any unshipped portion of Products sold hereunder and stop any Products in transit until Buyer pays all amounts, including amounts payable hereunder, whether or not then due, which are owing to it by Buyer. Buyer shall in any event remain liable for all unpaid accounts.
- Cancellation; Etc:** Orders are not subject to rescheduling or cancellation unless Buyer indemnifies Seller fully against all costs or expenses arising in connection therewith.
- Force Majeure:** Seller shall not be liable for any delay or failure in delivery resulting from causes beyond its control, including earthquakes, fires, floods, strikes or other labor disputes, shortage of labor or materials, accidents to machinery, acts of sabotage, riots, delay in or lack of transportation or the requirements of any government authority.
- Shipping; Delivery:** Unless otherwise expressly agreed in writing by Seller:
 - All sales and shipments of Products shall be FOB shipping point (unless otherwise stated in writing by Seller), at which point title to and all risk of loss of the Products shall pass from Seller to Buyer, provided that Seller shall retain a security interest in the Products until the full purchase price is paid by Buyer;
 - Delivery and shipping dates are estimates only; and
 - Seller will package Products as it deems proper for protection against normal handling and extra charges apply to special conditions.
- Claims:** Any claim by Buyer against Seller for shortage or damage to the Products occurring before delivery to the carrier or any claim related to pricing or other charges must be presented in detail in writing to Seller within 30 days of receipt of shipment.

III. PRECAUTIONS

- Suitability:** IT IS THE BUYER'S SOLE RESPONSIBILITY TO ENSURE THAT ANY OMRON PRODUCT IS FIT AND SUFFICIENT FOR USE IN A MOTORIZED VEHICLE APPLICATION. BUYER SHALL BE SOLELY RESPONSIBLE FOR DETERMINING APPROPRIATENESS OF THE PARTICULAR PRODUCT WITH RESPECT TO THE BUYER'S APPLICATION INCLUDING (A) ELECTRICAL OR ELECTRONIC COMPONENTS, (B) CIRCUITS, (C) SYSTEM ASSEMBLIES, (D) END PRODUCT, (E) SYSTEM, (F) MATERIALS OR SUBSTANCES OR (G) OPERATING ENVIRONMENT. Buyer acknowledges that it alone has determined that the Products will meet their requirements of the intended use in all cases. Buyer must know and observe all prohibitions of use applicable to the Product/s.
- Use with Attention:** The followings are some examples of applications for which particular attention must be given. This is not intended to be an exhaustive list of all possible use of any Product, nor to imply that any use listed may be suitable for any Product:
 - Outdoor use, use involving potential chemical contamination or electrical interference.

- Use in consumer Products or any use in significant quantities.
 - Energy control systems, combustion systems, railroad systems, aviation systems, medical equipment, amusement machines, vehicles, safety equipment, and installations subject to separate industry or government regulations.
 - Systems, machines, and equipment that could present a risk to life or property.
- Prohibited Use:** NEVER USE THE PRODUCT FOR AN APPLICATION INVOLVING SERIOUS RISK TO LIFE OR PROPERTY WITHOUT ENSURING THAT THE SYSTEM AS A WHOLE HAS BEEN DESIGNED TO ADDRESS THE RISKS, AND THAT THE PRODUCT IS PROPERLY RATED AND INSTALLED FOR THE INTENDED USE WITHIN THE OVERALL EQUIPMENT OR SYSTEM.
 - Motorized Vehicle Application:** USE OF ANY PRODUCT/S FOR A MOTORIZED VEHICLE APPLICATION MUST BE EXPRESSLY STATED IN THE SPECIFICATION BY SELLER.
 - Programmable Products:** Seller shall not be responsible for the Buyer's programming of a programmable Product.

IV. WARRANTY AND LIMITATION

- Warranty:** Seller's exclusive warranty is that the Products will be free from defects in materials and workmanship for a period of twelve months from the date of sale by Seller (or such other period expressed in writing by Seller). SELLER MAKES NO WARRANTY OR REPRESENTATION, EXPRESS OR IMPLIED, ABOUT ALL OTHER WARRANTIES, NON-INFRINGEMENT, MERCHANTABILITY OR FITNESS FOR A PARTICULAR PURPOSE OF THE PRODUCTS.
- Buyer Remedy:** Seller's sole obligation hereunder shall be to replace (in the form originally shipped with Buyer responsible for labor charges for removal or replacement thereof) the non-complying Product or, at Seller's election, to repay or credit Buyer an amount equal to the purchase price of the Product; provided that there shall be no liability for Seller or its affiliates unless Seller's analysis confirms that the Products were correctly handled, stored, installed and maintained and not subject to contamination, abuse, misuse or inappropriate modification. Return of any Products by Buyer must be approved in writing by Seller before shipment.
- Limitation on Liability:** SELLER AND ITS AFFILIATES SHALL NOT BE LIABLE FOR SPECIAL, INDIRECT, INCIDENTAL OR CONSEQUENTIAL DAMAGES, LOSS OF PROFITS OR PRODUCTION OR COMMERCIAL LOSS IN ANY WAY CONNECTED WITH THE PRODUCTS, WHETHER SUCH CLAIM IS BASED IN CONTRACT, WARRANTY, NEGLIGENCE OR STRICT LIABILITY. FURTHER, IN NO EVENT SHALL LIABILITY OF SELLER OR ITS AFFILIATES EXCEED THE INDIVIDUAL PRICE OF THE PRODUCT ON WHICH LIABILITY IS ASSERTED.
- Indemnities:** Buyer shall indemnify and hold harmless Seller, its affiliates and its employees from and against all liabilities, losses, claims, costs and expenses (including attorney's fees and expenses) related to any claim, investigation, litigation or proceeding (whether or not Seller is a party) which arises or is alleged to arise from Buyer's acts or omissions under these Terms or in any way with respect to the Products.

V. INFORMATION; ETC.

- Intellectual Property:** The intellectual property embodied in the Products is the exclusive property of Seller and its affiliates and Buyer shall not attempt to duplicate it in any way without the written permission of Seller. Buyer (at its own expense) shall indemnify and hold harmless Seller and defend or settle any action brought against Seller to the extent that it is based on a claim that any Product made to Buyer specifications infringed intellectual property rights of another party.
- Property; Confidentiality:** Notwithstanding any charges to Buyer for engineering or tooling, all engineering and tooling shall remain the exclusive property of Seller. All information and materials supplied by Seller to Buyer relating to the Products are confidential and proprietary, and Buyer shall limit distribution thereof to its trusted employees and strictly prevent disclosure to any third party.
- Performance Data:** Performance data is provided as a guide in determining suitability and does not constitute a warranty. It may represent the result of Seller's test conditions, and the users must correlate it to actual application requirements.
- Change In Specifications:** Product specifications and descriptions may be changed at any time based on improvements or other reasons. It is Seller's practice to change part numbers when published ratings or features are changed, or when significant engineering changes are made. However, some specifications of the Product may be changed without any notice.
- Errors And Omissions:** The information on Seller's website or in other documentation has been carefully checked and is believed to be accurate; however, no responsibility is assumed for clerical, typographical or proofreading errors or omissions.
- Export Controls:** Buyer shall comply with all applicable laws, regulations and licenses regarding (a) export of the Products or information provided by Seller; (b) sale of Products to forbidden or other proscribed persons or organizations; (c) disclosure to non-citizens of regulated technology or information.

VI. MISCELLANEOUS

- Waiver:** No failure or delay by Seller in exercising any right and no course of dealing between Buyer and Seller shall operate as a waiver of rights by Seller.
- Assignment:** Buyer may not assign its rights hereunder without Seller's written consent.
- Law:** These Terms are governed by Illinois law (without regard to conflict of laws). Federal and state courts in Cook County, Illinois have exclusive jurisdiction for any dispute hereunder.
- Amendment:** These Terms constitute the entire agreement between Buyer and Seller relating to the Products, and no provision may be changed or waived unless in writing signed by the parties.
- Severability:** If any provision hereof is rendered ineffective or invalid, such provision shall not invalidate any other provision.

Certain Precautions on Specifications and Use

1. **Suitability for Use.** Seller shall not be responsible for conformity with any standards, codes or regulations which apply to the combination of the Product in Buyer's application or use of the Product. At Buyer's request, Seller will provide applicable third party certification documents identifying ratings and limitations of use which apply to the Product. This information by itself is not sufficient for a complete determination of the suitability of the Product in combination with the end product, machine, system, or other application or use. Buyer shall be solely responsible for determining appropriateness of the particular Product with respect to Buyer's application, product or system. Buyer shall take application responsibility in all cases but the following is a non-exhaustive list of applications for which particular attention must be given:
 - (i) Outdoor use, uses involving potential chemical contamination or electrical interference, or conditions or uses not described in this document.
 - (ii) Energy control systems, combustion systems, railroad systems, aviation systems, medical equipment, amusement machines, vehicles, safety equipment, and installations subject to separate industry or government regulations.
 - (iii) Use in consumer products or any use in significant quantities.
 - (iv) Systems, machines and equipment that could present a risk to life or property. Please know and observe all prohibitions of use applicable to this product.

NEVER USE THE PRODUCT FOR AN APPLICATION INVOLVING SERIOUS RISK TO LIFE OR PROPERTY WITHOUT ENSURING THAT THE SYSTEM AS A WHOLE HAS BEEN DESIGNED TO ADDRESS THE RISKS, AND THAT THE OMRON PRODUCT IS PROPERLY RATED AND INSTALLED FOR THE INTENDED USE WITHIN THE OVERALL EQUIPMENT OR SYSTEM.
2. **Programmable Products.** Seller shall not be responsible for the user's programming of a programmable product, or any consequence thereof.
3. **Performance Data.** Performance data given in this publication is provided as a guide for the user in determining suitability and does not constitute a warranty. It may represent the result of Seller's test conditions, and the users must correlate it to actual application requirements. Actual performance is subject to Seller's Warranty and Limitations of Liability.
4. **Change in Specifications.** Product specifications and accessories may be changed at any time based on improvements and other reasons. It is our practice to change part numbers when published ratings or features are changed, or when significant construction changes are made. However, some specifications of the Product may be changed without any notice. When in doubt, special part numbers may be assigned to fix or establish key specifications for your application. Please consult with your Seller representative at any time to confirm actual specifications of purchased Product.
5. **Errors and Omissions.** The information in this publication has been carefully checked and is believed to be accurate; however, no responsibility is assumed for clerical, typographical or proofreading errors, or omissions.
6. **RoHS Compliance.** Where indicated, our products currently comply, to the best of our knowledge as of the date of this publication, with the requirements of the European Union's Directive on the Restriction of certain Hazardous Substances ("RoHS"), although the requirements of RoHS do not take effect until July 2006. These requirements may be subject to change. Please consult our website for current information.

Complete "Terms and Conditions of Sale" for product purchase and use are on Omron's website at <http://www.components.omron.com> – under the "About Us" tab, in the Legal Matters section.

ALL DIMENSIONS SHOWN ARE IN MILLIMETERS.

To convert millimeters into inches, multiply by 0.03937. To convert grams into ounces, multiply by 0.03527.

OMRON®

**OMRON ELECTRONIC
COMPONENTS LLC**

55 E. Commerce Drive, Suite B
Schaumburg, IL 60173

847-882-2288

OMRON ON-LINE

Global - <http://www.omron.com>

USA - <http://www.components.omron.com>