

# BC637; BCP55; BCX55

60 V, 1 A NPN medium power transistors

Rev. 07 — 25 June 2007

Product data sheet

## 1. Product profile

### 1.1 General description

NPN medium power transistor series.

Table 1. Product overview

Type number <sup>[1]</sup>	Package			PNP complement
	NXP	JEITA	JEDEC	
BC637 <sup>[2]</sup>	SOT54	SC-43A	TO-92	BC638
BCP55	SOT223	SC-73	-	BCP52
BCX55	SOT89	SC-62	TO-243	BCX52

[1] Valid for all available selection groups.

[2] Also available in SOT54A and SOT54 variant packages (see [Section 2](#)).

### 1.2 Features

- High current
- Two current gain selections
- High power dissipation capability

### 1.3 Applications

- Linear voltage regulators
- Low-side switches
- MOSFET drivers
- Amplifiers

### 1.4 Quick reference data

Table 2. Quick reference data

Symbol	Parameter	Conditions	Min	Typ	Max	Unit
$V_{CEO}$	collector-emitter voltage	open base	-	-	60	V
$I_C$	collector current		-	-	1	A
$I_{CM}$	peak collector current	single pulse; $t_p \leq 1$ ms	-	-	1.5	A
$h_{FE}$	DC current gain	$V_{CE} = 2$ V; $I_C = 150$ mA	63	-	250	
	$h_{FE}$ selection -10	$V_{CE} = 2$ V; $I_C = 150$ mA	63	-	160	
	$h_{FE}$ selection -16	$V_{CE} = 2$ V; $I_C = 150$ mA	100	-	250	

## 2. Pinning information

**Table 3. Pinning**

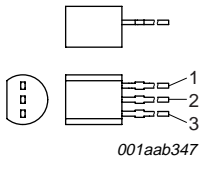
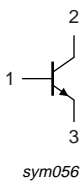
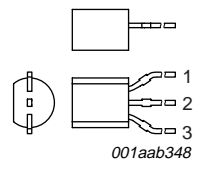
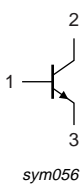
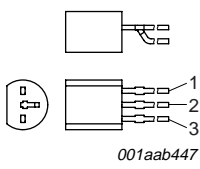
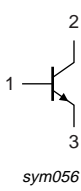
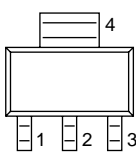
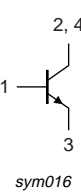
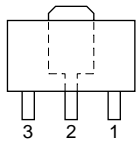
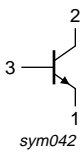
Pin	Description	Simplified outline	Symbol
<b>SOT54</b>			
1	base		
2	collector		
3	emitter		
<b>SOT54A</b>			
1	base		
2	collector		
3	emitter		
<b>SOT54 variant</b>			
1	base		
2	collector		
3	emitter		
<b>SOT223</b>			
1	base		
2	collector		
3	emitter		
4	collector		
<b>SOT89</b>			
1	emitter		
2	collector		
3	base		

### 3. Ordering information

**Table 4. Ordering information**

Type number <sup>[1]</sup>	Package		
	Name	Description	Version
BC637 <sup>[2]</sup>	SC-43A	plastic single-ended leaded (through hole) package; 3 leads	SOT54
BCP55	SC-73	plastic surface-mounted package with increased heatsink; 4 leads	SOT223
BCX55	SC-62	plastic surface-mounted package; collector pad for good heat transfer; 3 leads	SOT89

[1] Valid for all available selection groups.

[2] Also available in SOT54A and SOT54 variant packages (see [Section 2](#) and [Section 9](#)).

### 4. Marking

**Table 5. Marking codes**

Type number	Marking code
BC637	C637
BC637-16	C63716
BCP55	BCP55
BCP55-10	BCP55/10
BCP55-16	BCP55/16
BCX55	BE
BCX55-10	BG
BCX55-16	BM

## 5. Limiting values

**Table 6. Limiting values**

*In accordance with the Absolute Maximum Rating System (IEC 60134).*

Symbol	Parameter	Conditions	Min	Max	Unit	
$V_{CBO}$	collector-base voltage	open emitter	-	60	V	
$V_{CEO}$	collector-emitter voltage	open base	-	60	V	
$V_{EBO}$	emitter-base voltage	open collector	-	5	V	
$I_C$	collector current		-	1	A	
$I_{CM}$	peak collector current	single pulse; $t_p \leq 1$ ms	-	1.5	A	
$I_{BM}$	peak base current	single pulse; $t_p \leq 1$ ms	-	0.2	A	
$P_{tot}$	total power dissipation	$T_{amb} \leq 25$ °C				
			BC637	[1] -	0.83	W
			BCP55	[1] -	0.64	W
				[2] -	0.96	W
			BCX55	[1] -	0.5	W
				[2] -	0.85	W
[3] -	1.25	W				
$T_j$	junction temperature		-	150	°C	
$T_{amb}$	ambient temperature		-65	+150	°C	
$T_{stg}$	storage temperature		-65	+150	°C	

[1] Device mounted on an FR4 Printed-Circuit Board (PCB), single-sided copper, tin-plated and standard footprint.

[2] Device mounted on an FR4 PCB, single-sided copper, tin-plated, mounting pad for collector 1 cm<sup>2</sup>.

[3] Device mounted on an FR4 PCB, single-sided copper, tin-plated, mounting pad for collector 6 cm<sup>2</sup>.

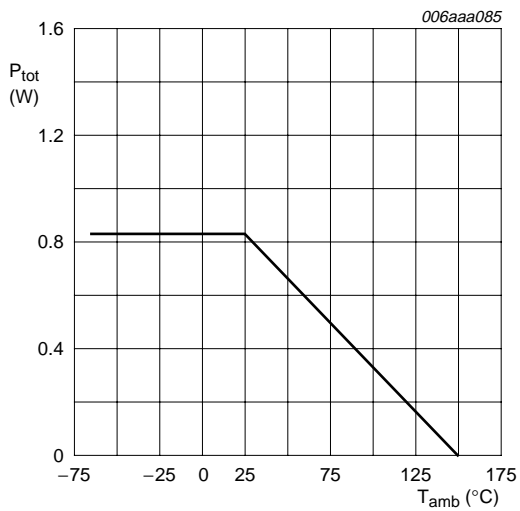

FR4 PCB, standard footprint

**Fig 1. Power derating curve SOT54**

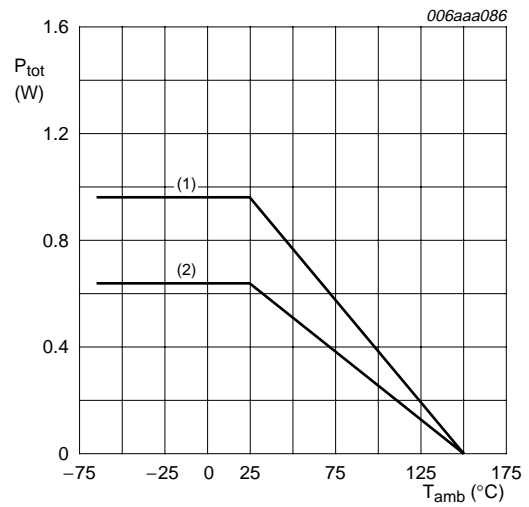

- (1) FR4 PCB, mounting pad for collector 1 cm<sup>2</sup>
- (2) FR4 PCB, standard footprint

**Fig 2. Power derating curves SOT223**

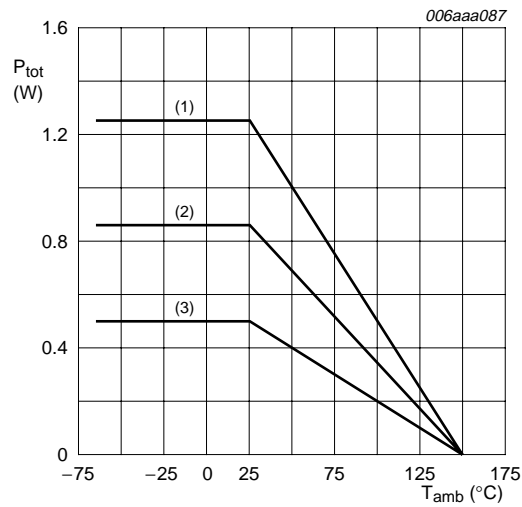

- (1) FR4 PCB, mounting pad for collector 6 cm<sup>2</sup>
- (2) FR4 PCB, mounting pad for collector 1 cm<sup>2</sup>
- (3) FR4 PCB, standard footprint

**Fig 3. Power derating curves SOT89**

**6. Thermal characteristics**

**Table 7. Thermal characteristics**

Symbol	Parameter	Conditions	Min	Typ	Max	Unit		
$R_{th(j-a)}$	thermal resistance from junction to ambient	in free air						
			BC637	[1]	-	-	150	K/W
			BCP55	[1]	-	-	195	K/W
				[2]	-	-	130	K/W
			BCX55	[1]	-	-	250	K/W
				[2]	-	-	145	K/W
[3]	-	-		100	K/W			
$R_{th(j-sp)}$	thermal resistance from junction to solder point							
		BC637	-	-	40	K/W		
		BCP55	-	-	17	K/W		
		BCX55	-	-	30	K/W		

- [1] Device mounted on an FR4 PCB, single-sided copper, tin-plated and standard footprint.
- [2] Device mounted on an FR4 PCB, single-sided copper, tin-plated, mounting pad for collector 1 cm<sup>2</sup>.
- [3] Device mounted on an FR4 PCB, single-sided copper, tin-plated, mounting pad for collector 6 cm<sup>2</sup>.

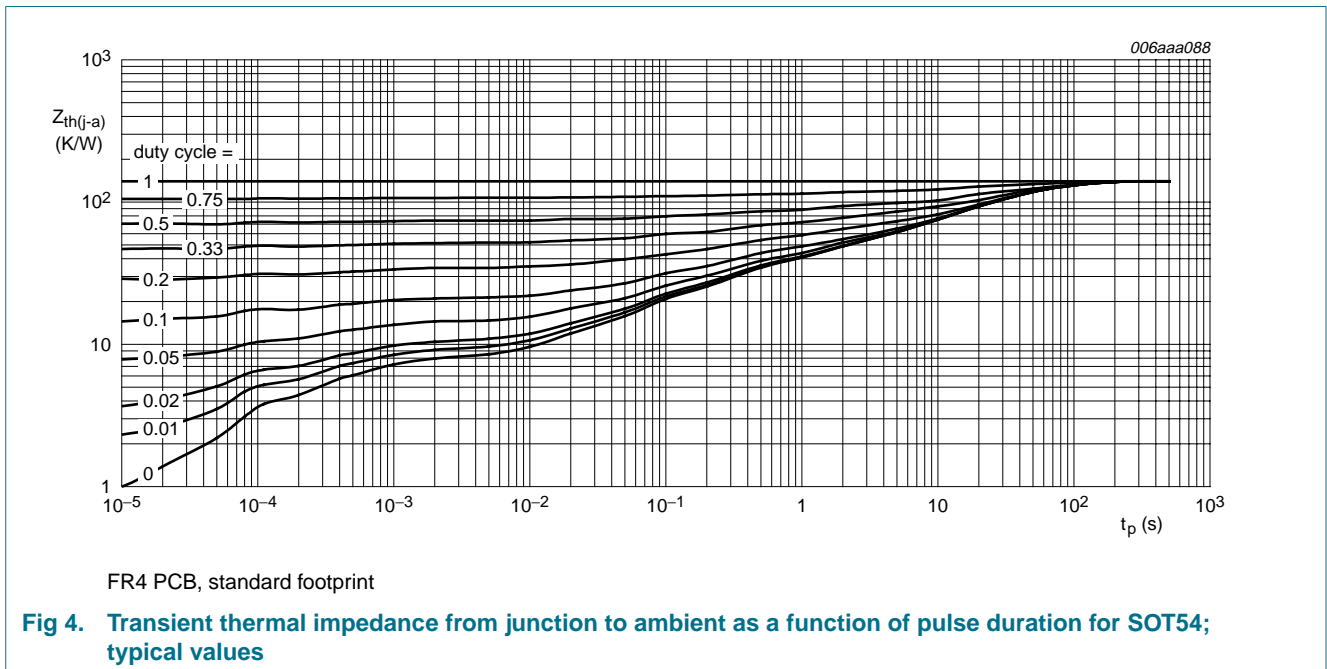

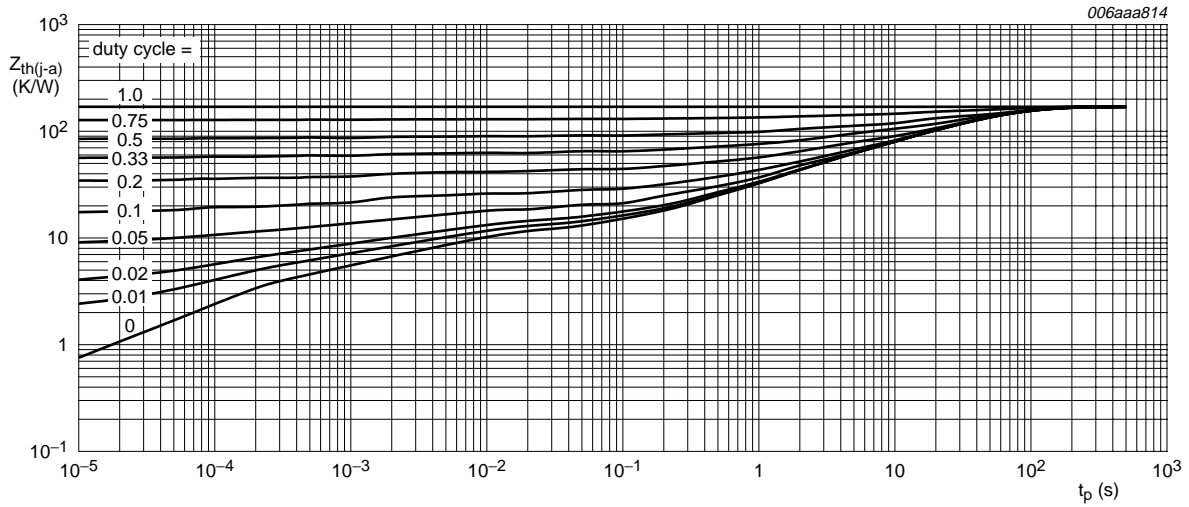

FR4 PCB, standard footprint

**Fig 5. Transient thermal impedance from junction to ambient as a function of pulse duration for SOT223; typical values**

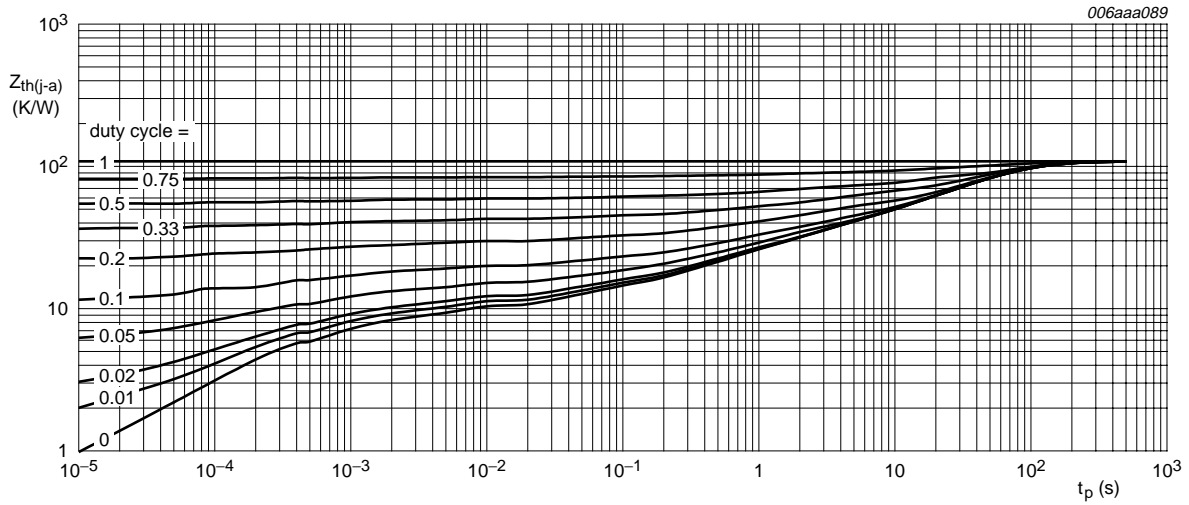

FR4 PCB, mounting pad for collector 1 cm<sup>2</sup>

**Fig 6. Transient thermal impedance from junction to ambient as a function of pulse duration for SOT223; typical values**

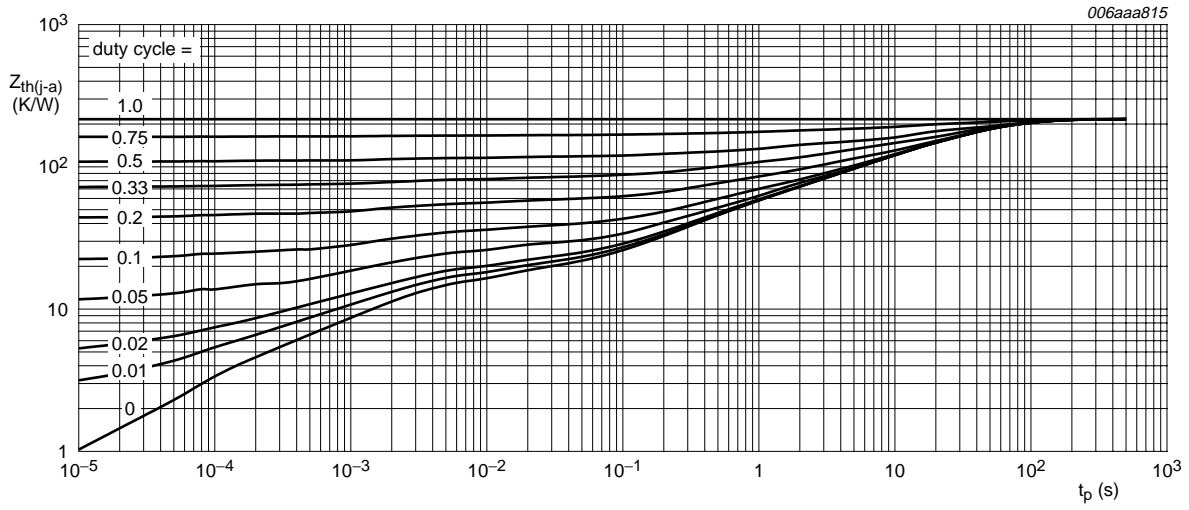

FR4 PCB, standard footprint

**Fig 7. Transient thermal impedance from junction to ambient as a function of pulse duration for SOT89; typical values**

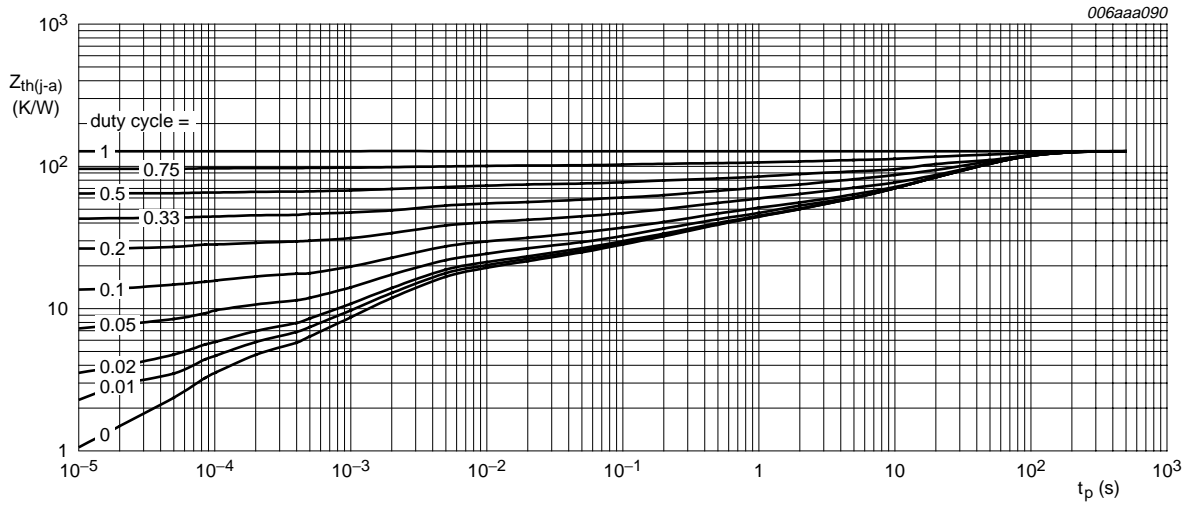

FR4 PCB, mounting pad for collector 1 cm<sup>2</sup>

**Fig 8. Transient thermal impedance from junction to ambient as a function of pulse duration for SOT89; typical values**



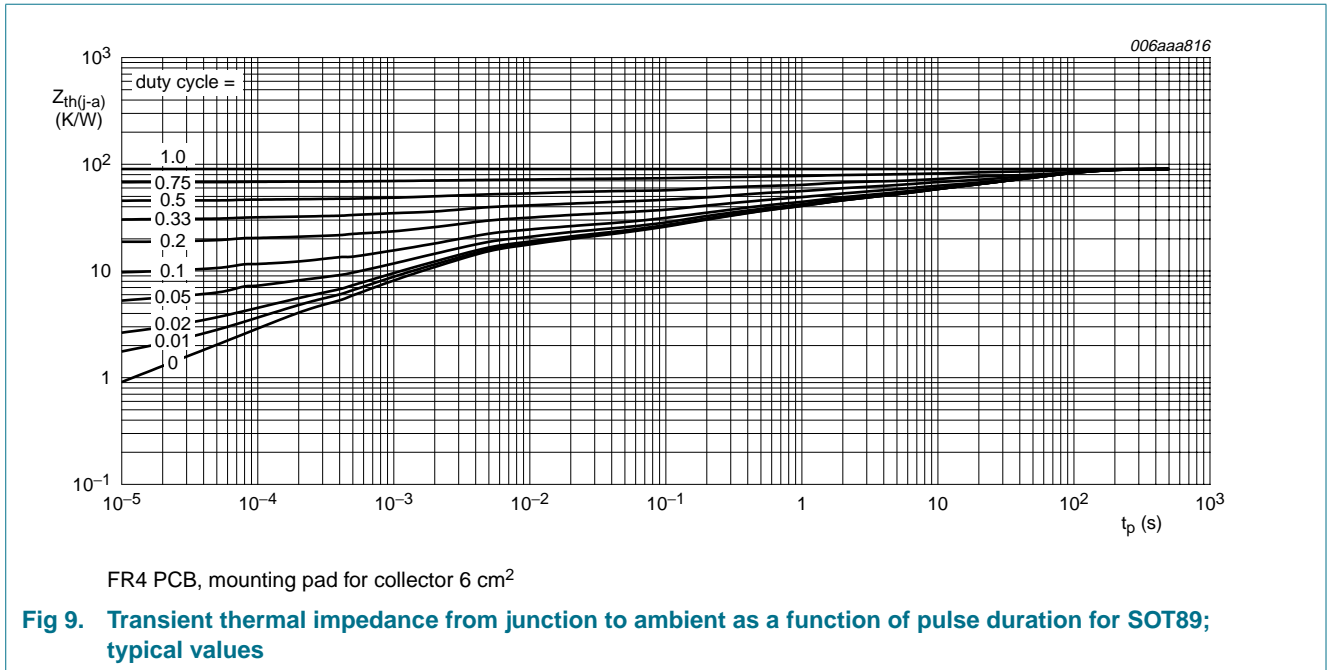

## 7. Characteristics

**Table 8. Characteristics**

*T<sub>amb</sub> = 25 °C unless otherwise specified.*

Symbol	Parameter	Conditions	Min	Typ	Max	Unit
I <sub>CBO</sub>	collector-base cut-off current	V <sub>CB</sub> = 30 V; I <sub>E</sub> = 0 A	-	-	100	nA
		V <sub>CB</sub> = 30 V; I <sub>E</sub> = 0 A; T <sub>j</sub> = 150 °C	-	-	10	μA
I <sub>EBO</sub>	emitter-base cut-off current	V <sub>EB</sub> = 5 V; I <sub>C</sub> = 0 A	-	-	100	nA
h <sub>FE</sub>	DC current gain	V <sub>CE</sub> = 2 V				
		I <sub>C</sub> = 5 mA	63	-	-	
		I <sub>C</sub> = 150 mA	63	-	250	
		I <sub>C</sub> = 500 mA	[1] 40	-	-	
	DC current gain	V <sub>CE</sub> = 2 V				
	h <sub>FE</sub> selection -10	I <sub>C</sub> = 150 mA	63	-	160	
	h <sub>FE</sub> selection -16	I <sub>C</sub> = 150 mA	100	-	250	
V <sub>CEsat</sub>	collector-emitter saturation voltage	I <sub>C</sub> = 500 mA; I <sub>B</sub> = 50 mA	[1] -	-	500	mV
V <sub>BE</sub>	base-emitter voltage	V <sub>CE</sub> = 2 V; I <sub>C</sub> = 500 mA	[1] -	-	1	V
C <sub>C</sub>	collector capacitance	V <sub>CB</sub> = 10 V; I <sub>E</sub> = i <sub>e</sub> = 0 A; f = 1 MHz	-	6	-	pF
f <sub>T</sub>	transition frequency	V <sub>CE</sub> = 5 V; I <sub>C</sub> = 50 mA; f = 100 MHz	100	180	-	MHz

[1] Pulse test: t<sub>p</sub> ≤ 300 μs; δ = 0.02.

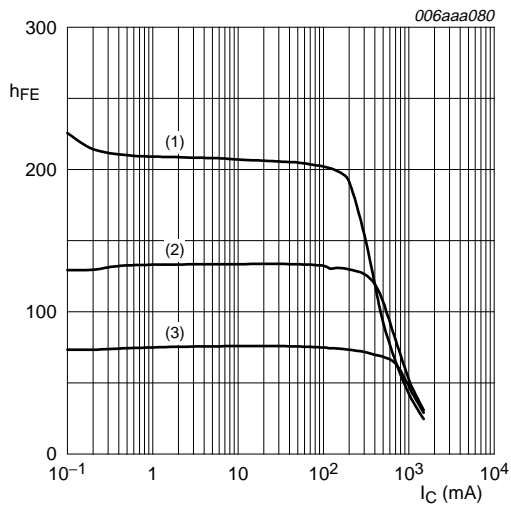

$V_{CE} = 2 \text{ V}$

- (1)  $T_{amb} = 150 \text{ }^\circ\text{C}$
- (2)  $T_{amb} = 25 \text{ }^\circ\text{C}$
- (3)  $T_{amb} = -55 \text{ }^\circ\text{C}$

**Fig 10. DC current gain as a function of collector current; typical values**

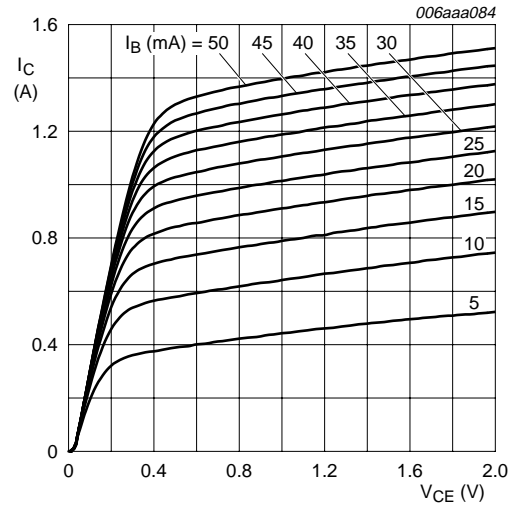

$T_{amb} = 25 \text{ }^\circ\text{C}$

**Fig 11. Collector current as a function of collector-emitter voltage; typical values**

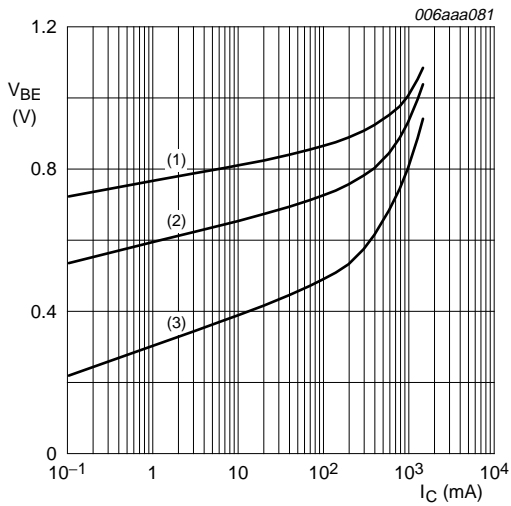

$V_{CE} = 2 \text{ V}$

- (1)  $T_{amb} = -55 \text{ }^\circ\text{C}$
- (2)  $T_{amb} = 25 \text{ }^\circ\text{C}$
- (3)  $T_{amb} = 150 \text{ }^\circ\text{C}$

**Fig 12. Base-emitter voltage as a function of collector current; typical values**

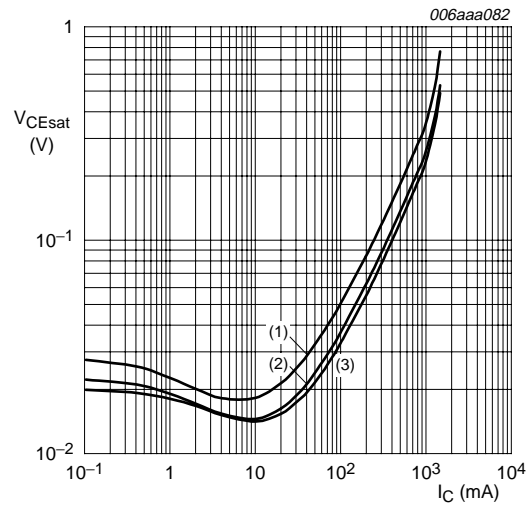

$I_C/I_B = 10$

- (1)  $T_{amb} = 150 \text{ }^\circ\text{C}$
- (2)  $T_{amb} = 25 \text{ }^\circ\text{C}$
- (3)  $T_{amb} = -55 \text{ }^\circ\text{C}$

**Fig 13. Collector-emitter saturation voltage as a function of collector current; typical values**

**8. Package outline**

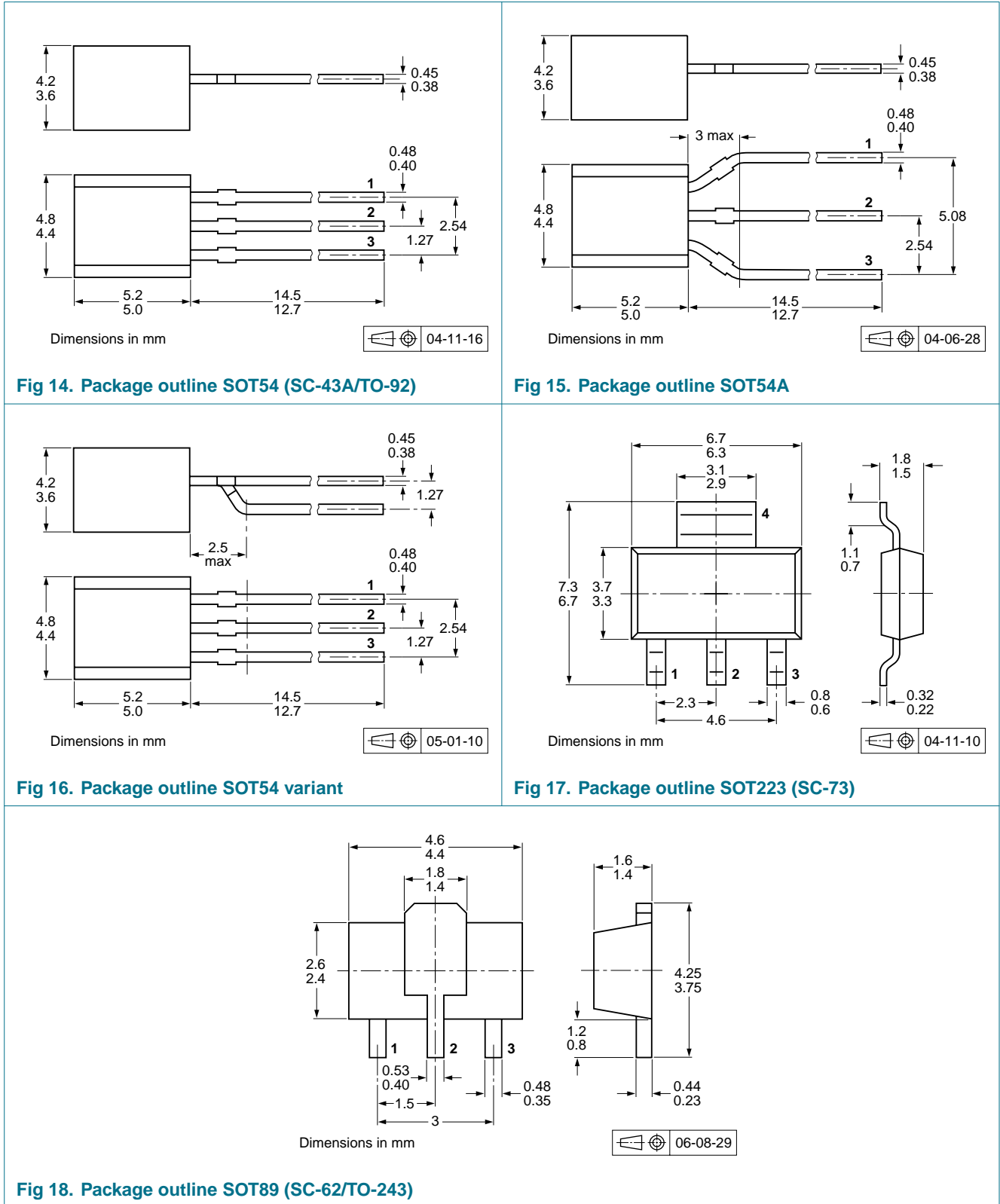

## 9. Packing information

**Table 9. Packing methods**

The indicated -xxx are the last three digits of the 12NC ordering code.<sup>[1]</sup>

Type number <sup>[2]</sup>	Package	Description	Packing quantity			
			1000	4000	5000	10000
BC637	SOT54	bulk, straight leads	-	-	-412	-
	SOT54A	tape and reel, wide pitch	-	-	-	-116
		tape ammopack, wide pitch	-	-	-	-126
	SOT54 variant	bulk, delta pinning	-	-	-112	-
BCP55	SOT223	8 mm pitch, 12 mm tape and reel	-115	-135	-	-
BCX55	SOT89	8 mm pitch, 12 mm tape and reel; T1	<sup>[3]</sup> -115	-135	-	-
		8 mm pitch, 12 mm tape and reel; T3	<sup>[4]</sup> -120	-	-	-

[1] For further information and the availability of packing methods, see [Section 12](#).

[2] Valid for all available selection groups.

[3] T1: normal taping

[4] T3: 90° rotated taping

## 10. Revision history

**Table 10. Revision history**

Document ID	Release date	Data sheet status	Change notice	Supersedes
BC637_BCP55_BCX55_7	20070625	Product data sheet	-	BC637_BCP55_BCX55_6
Modifications: <ul style="list-style-type: none"> <li>• The format of this data sheet has been redesigned to comply with the new identity guidelines of NXP Semiconductors.</li> <li>• Legal texts have been adapted to the new company name where appropriate.</li> <li>• <a href="#">Table 1 “Product overview”</a>: amended</li> <li>• <a href="#">Section 1.2 “Features”</a>: amended</li> <li>• <a href="#">Section 1.3 “Applications”</a>: amended</li> <li>• <a href="#">Table 2 “Quick reference data”</a>: I<sub>C</sub> parameter redefined to collector current</li> <li>• <a href="#">Table 2 “Quick reference data”</a>: I<sub>CM</sub> condition added</li> <li>• <a href="#">Figure 2</a> and <a href="#">3</a>: amended</li> <li>• <a href="#">Table 6 “Limiting values”</a>: I<sub>C</sub> parameter redefined to collector current</li> <li>• <a href="#">Table 6 “Limiting values”</a>: I<sub>CM</sub> condition added</li> <li>• <a href="#">Table 6 “Limiting values”</a>: P<sub>tot</sub> values for BCP55 and BCX55 adapted</li> <li>• <a href="#">Table 7 “Thermal characteristics”</a>: R<sub>th(j-a)</sub> values for BCP55 and BCX55 rounded</li> <li>• <a href="#">Figure 4</a>: Z<sub>th</sub> redefined to Z<sub>th(j-a)</sub> transient thermal impedance from junction to ambient</li> <li>• <a href="#">Figure 4</a>: t<sub>p</sub> parameter redefined to pulse duration</li> <li>• <a href="#">Figure 5</a>: added</li> <li>• <a href="#">Figure 6</a>: Z<sub>th</sub> redefined to Z<sub>th(j-a)</sub> transient thermal impedance from junction to ambient</li> <li>• <a href="#">Figure 6</a>: t<sub>p</sub> parameter redefined to pulse duration</li> <li>• <a href="#">Figure 7</a>: added</li> <li>• <a href="#">Figure 8</a>: Z<sub>th</sub> redefined to Z<sub>th(j-a)</sub> transient thermal impedance from junction to ambient</li> <li>• <a href="#">Figure 8</a>: t<sub>p</sub> parameter redefined to pulse duration</li> <li>• <a href="#">Figure 9</a>: added</li> <li>• <a href="#">Figure 11</a>: amended</li> <li>• <a href="#">Table 9 “Packing methods”</a>: new packing method for BCX55 added</li> <li>• <a href="#">Section 11 “Legal information”</a>: updated</li> </ul>				
BC637_BCP55_BCX55_6	20050218	Product data sheet	CPCN200405029	BC635_637_639_4 BCP54_55_56_5 BCX54_55_56_4
BC635_637_639_4	20011010	Product specification	-	BC635_637_639_3
BCP54_55_56_5	20030206	Product specification	-	BCP54_55_56_4
BCX54_55_56_4	20011010	Product specification	-	BCX54_55_56_3

## 11. Legal information

### 11.1 Data sheet status

Document status <sup>[1][2]</sup>	Product status <sup>[3]</sup>	Definition
Objective [short] data sheet	Development	This document contains data from the objective specification for product development.
Preliminary [short] data sheet	Qualification	This document contains data from the preliminary specification.
Product [short] data sheet	Production	This document contains the product specification.

[1] Please consult the most recently issued document before initiating or completing a design.

[2] The term 'short data sheet' is explained in section "Definitions".

[3] The product status of device(s) described in this document may have changed since this document was published and may differ in case of multiple devices. The latest product status information is available on the Internet at URL <http://www.nxp.com>.

### 11.2 Definitions

**Draft** — The document is a draft version only. The content is still under internal review and subject to formal approval, which may result in modifications or additions. NXP Semiconductors does not give any representations or warranties as to the accuracy or completeness of information included herein and shall have no liability for the consequences of use of such information.

**Short data sheet** — A short data sheet is an extract from a full data sheet with the same product type number(s) and title. A short data sheet is intended for quick reference only and should not be relied upon to contain detailed and full information. For detailed and full information see the relevant full data sheet, which is available on request via the local NXP Semiconductors sales office. In case of any inconsistency or conflict with the short data sheet, the full data sheet shall prevail.

### 11.3 Disclaimers

**General** — Information in this document is believed to be accurate and reliable. However, NXP Semiconductors does not give any representations or warranties, expressed or implied, as to the accuracy or completeness of such information and shall have no liability for the consequences of use of such information.

**Right to make changes** — NXP Semiconductors reserves the right to make changes to information published in this document, including without limitation specifications and product descriptions, at any time and without notice. This document supersedes and replaces all information supplied prior to the publication hereof.

**Suitability for use** — NXP Semiconductors products are not designed, authorized or warranted to be suitable for use in medical, military, aircraft, space or life support equipment, nor in applications where failure or

malfunction of a NXP Semiconductors product can reasonably be expected to result in personal injury, death or severe property or environmental damage. NXP Semiconductors accepts no liability for inclusion and/or use of NXP Semiconductors products in such equipment or applications and therefore such inclusion and/or use is at the customer's own risk.

**Applications** — Applications that are described herein for any of these products are for illustrative purposes only. NXP Semiconductors makes no representation or warranty that such applications will be suitable for the specified use without further testing or modification.

**Limiting values** — Stress above one or more limiting values (as defined in the Absolute Maximum Ratings System of IEC 60134) may cause permanent damage to the device. Limiting values are stress ratings only and operation of the device at these or any other conditions above those given in the Characteristics sections of this document is not implied. Exposure to limiting values for extended periods may affect device reliability.

**Terms and conditions of sale** — NXP Semiconductors products are sold subject to the general terms and conditions of commercial sale, as published at <http://www.nxp.com/profile/terms>, including those pertaining to warranty, intellectual property rights infringement and limitation of liability, unless explicitly otherwise agreed to in writing by NXP Semiconductors. In case of any inconsistency or conflict between information in this document and such terms and conditions, the latter will prevail.

**No offer to sell or license** — Nothing in this document may be interpreted or construed as an offer to sell products that is open for acceptance or the grant, conveyance or implication of any license under any copyrights, patents or other industrial or intellectual property rights.

### 11.4 Trademarks

Notice: All referenced brands, product names, service names and trademarks are the property of their respective owners.

## 12. Contact information

For additional information, please visit: <http://www.nxp.com>

For sales office addresses, send an email to: [salesaddresses@nxp.com](mailto:salesaddresses@nxp.com)

**13. Contents**

**1 Product profile . . . . . 1**

1.1 General description . . . . . 1

1.2 Features . . . . . 1

1.3 Applications . . . . . 1

1.4 Quick reference data . . . . . 1

**2 Pinning information . . . . . 2**

**3 Ordering information . . . . . 3**

**4 Marking . . . . . 3**

**5 Limiting values . . . . . 4**

**6 Thermal characteristics . . . . . 6**

**7 Characteristics . . . . . 9**

**8 Package outline . . . . . 11**

**9 Packing information . . . . . 12**

**10 Revision history . . . . . 13**

**11 Legal information . . . . . 14**

11.1 Data sheet status . . . . . 14

11.2 Definitions . . . . . 14

11.3 Disclaimers . . . . . 14

11.4 Trademarks . . . . . 14

**12 Contact information . . . . . 14**

**13 Contents . . . . . 15**

Please be aware that important notices concerning this document and the product(s) described herein, have been included in section 'Legal information'.



© NXP B.V. 2007.

All rights reserved.

For more information, please visit: <http://www.nxp.com>

For sales office addresses, please send an email to: [salesaddresses@nxp.com](mailto:salesaddresses@nxp.com)

Date of release: 25 June 2007

Document identifier: BC637\_BCP55\_BCX55\_7