

Metallized Polyester Film Capacitor MKT Axial Type

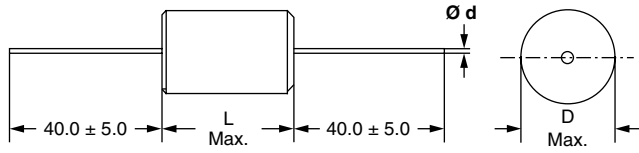

Dimensions in mm

LEAD DIAMETER d (mm)	D (mm)
0.6	≤ 5.0
0.7	> 5.0 ≤ 7.0
0.8	> 7.0 < 16.5
1.0	≥ 16.5

MAIN APPLICATIONS

Blocking, bypassing, filtering, timing, coupling and decoupling, interference suppression in low voltage applications

REFERENCE STANDARDS

IEC 60384-2

MARKING

C-value; tolerance; rated voltage; manufacturer's type; code for dielectric material; manufacturer location; manufacturer's logo; year and week

DIELECTRIC

Polyester film

ELECTRODES

Metallized

CONSTRUCTION

Mono and internal series construction

RATED (DC) VOLTAGE

63 V, 100 V, 250 V, 400 V, 630 V, 1000 V

RATED (AC) VOLTAGE

40 V, 63 V, 160 V, 200 V, 220 V

FEATURES

Supplied loose in box, taped on ammpack or reel
RoHS compliant



ENCAPSULATION

Plastic-wrapped, epoxy resin sealed, flame retardant



RoHS
COMPLIANT

CLIMATIC TESTING CLASS ACC. TO IEC 60068-1

55/100/56

CAPACITANCE RANGE (E12 SERIES)

470 pF to 22 μF

CAPACITANCE TOLERANCE

± 20 %, ± 10 %, ± 5 %

LEADS

Tinned wire

MAXIMUM APPLICATION TEMPERATURE

100 °C

PULL TEST ON LEADS

Minimum 20 N in direction of leads according to IEC 60068-2-21

BENT TEST ON LEADS

2 bends trough 90° combined with 10 N tensile strength

RELIABILITY

Operational life > 300 000 h (40 °C/0.5 U_R)
Failure Rate < 2 FIT (40 °C/0.5 U_R)

DETAIL SPECIFICATION

For more detailed data and test requirements contact:
dc-film@vishay.com



COMPOSITION OF CATALOG NUMBER

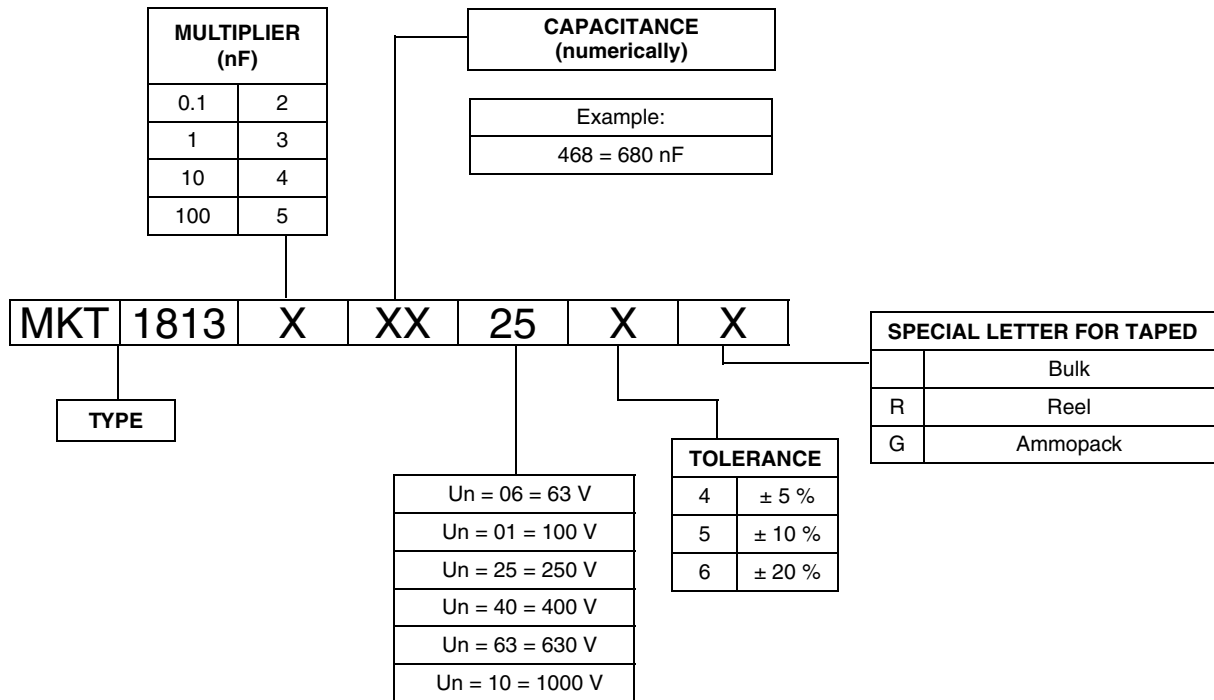

Note

For detailed tape specifications refer to "Packaging Information" www.vishay.com/docs?28139 or end of catalog

SPECIFIC REFERENCE DATA

DESCRIPTION		VALUE				
Tangent of loss angle:		at 1 kHz		at 10 kHz		at 100 kHz
C = 0.1 μF		= 80 x 10 ⁻⁴		= 150 x 10 ⁻⁴		= 250 x 10 ⁻⁴
0.1 μF ≤ C = 1.0 μF		= 80 x 10 ⁻⁴		= 150 x 10 ⁻⁴		-
C ≥ 1.0 μF		= 100 x 10 ⁻⁴		-		-
Capacitor length (mm)	Maximum pulse rise time (dU/dt) _R [V/μs]					
	63 Vdc	100 Vdc	250 Vdc	400 Vdc	630 Vdc	1000 Vdc
11	12	18	32	56	84	-
14	11	13	22	37	66	175
19	7	8	13	21	33	65
26.5	4	5	8	13	19	34
31.5	3	4	6	10	15	25
41.5	2	3	5	7	10	17
If the maximum pulse voltage is less than the rated voltage higher dU/dt values can be permitted.						
R between leads, for C ≤ 0.33 μF and U _R ≤ 100 V					> 15 000 MΩ	
R between leads, for C ≤ 0.33 μF and U _R > 100 V					> 30 000 MΩ	
RC between leads, for C > 0.33 μF and U _R ≤ 100 V					> 5000 s	
RC between leads, for C > 0.33 μF and U _R > 100 V					> 10 000 s	
R between leads and case, 100 V; (Foil Method)					> 30 000 MΩ	
Withstanding (DC) voltage (cut off current 10 mA); rise time 100 V/s					1.6 x U _{Rdc} ; 1 min	
Maximum application temperature					100 °C	

Vishay BCcomponents Metallized Polyester Film Capacitor
MKT Axial Type

CAPACITANCE	CAPACITANCE CODE	VOLTAGE CODE 06 63 Vdc/ 40 Vac		VOLTAGE CODE 01 100 Vdc/ 63 Vac		VOLTAGE CODE 25 250 Vdc/ 160 Vac		VOLTAGE CODE 40 400 Vdc/ 200 Vac		VOLTAGE CODE 63 ⁽¹⁾ 630 Vdc/ 220 Vac		VOLTAGE CODE 10 ⁽¹⁾ 1000 Vdc/ 220 Vac	
		D	L	D	L	D	L	D	L	D	L	D	L
470 PF	147	-	-	-	-	-	-	-	-	5.0	11.0	-	-
680 PF	168	-	-	-	-	-	-	-	-	5.0	11.0	-	-
1000 PF	210	-	-	-	-	-	-	-	-	5.0	11.0	5.5	14.0
1500 PF	215	-	-	-	-	-	-	-	-	5.0	11.0	6.0	14.0
2200 PF	222	-	-	-	-	-	-	-	-	5.0	11.0	6.0	14.0
3300 PF	233	-	-	-	-	-	-	-	-	5.0	11.0	7.0	14.0
4700 PF	247	-	-	-	-	-	-	-	-	5.0	11.0	6.0	19.0
6800 PF	268	-	-	-	-	-	-	5.0	11.0	6.0	14.0	6.0	19.0
0.01 µF	310	-	-	-	-	-	-	5.0	11.0	6.0	14.0	6.5	19.0
0.015 µF	315	-	-	-	-	5.0	11.0	6.0	14.0	6.5	14.0	7.5	19.0
0.022 µF	322	-	-	-	-	5.0	11.0	6.0	14.0	7.5	14.0	9.0	19.0
0.033 µF	333	-	-	-	-	5.0	11.0	6.0	14.0	6.5	19.0	10.5	19.0
0.047 µF	347	-	-	-	-	6.0	14.0	7.0	14.0	7.5	19.0	12.0	19.0
0.068 µF	368	-	-	5.0	11.0	6.0	14.0	8.0	14.0	8.5	19.0	11.0	26.5
0.1 µF	410	-	-	5.0	11.0	6.0	14.0	7.0	19.0	10.5	19.0	13.0	26.5
		-	-	-	-	-	-	-	-	9.5	19.0 ⁽²⁾	-	-
0.15 µF	415	5.0	11.0	5.5	11.0	7.0	14.0	8.5	19.0	10.0	26.5	13.5	31.5
0.22 µF	422	5.0	11.0	6.0	14.0	7.0	19.0	8.0	26.5	11.5	26.5	16.0	31.5
		-	-	-	-	-	-	8.0	19.0 ⁽²⁾	-	-	-	-
0.33 µF	433	6.0	14.0	6.0	19.0	8.0	19.0	9.5	26.5	13.5	26.5	16.0	41.5
		-	-	-	-	-	-	9.5	19.0 ⁽²⁾	-	-	-	-
0.47 µF	447	7.0	14.0	6.5	19.0	9.0	19.0	11.0	26.5	14.5	31.5	19.0	41.5
		-	-	-	-	-	-	-	-	14.0	26.5 ⁽²⁾	-	-
0.68 µF	468	6.5	19.0	7.0	19.0	8.5	26.5	11.5	31.5	14.5	41.5	-	-
		-	-	-	-	9.0	19.0 ⁽²⁾	-	-	-	-	-	-
1.0 µF	510	7.5	19.0	8.5	19.0	10.0	26.5	13.5	31.5	16.5	41.5	-	-
1.5 µF	515	8.5	19.0	8.0	26.5	11.0	31.5	14.0	41.5	-	-	-	-
		-	-	8.0	19.0 ⁽²⁾	-	-	13.0	31.5 ⁽²⁾	-	-	-	-
2.2 µF	522	8.5	26.5	9.5	26.5	13.0	31.5	16.5	41.5	-	-	-	-
		7.5	19.0 ⁽²⁾	9.5	19.0 ⁽²⁾	-	-	-	-	-	-	-	-
3.3 µF	533	10.0	26.5	11.5	26.5	15.5	31.5	-	-	-	-	-	-
		8.5	19.0 ⁽²⁾	-	-	14.0	26.5 ⁽²⁾	-	-	-	-	-	-
4.7 µF	547	11.5	26.5	12.0	31.5	15.5	41.5	-	-	-	-	-	-
		-	-	-	-	14.5	31.5 ⁽²⁾	-	-	-	-	-	-
6.8 µF	568	12.0	31.5	14.0	31.5	17.5	41.5	-	-	-	-	-	-
10.0 µF	610	14.5	31.5	16.5	31.5	21.0	41.5	-	-	-	-	-	-
		-	-	13.5	31.5 ⁽²⁾	-	-	-	-	-	-	-	-
15.0 µF	615	18.0	31.5	20.5	31.5	-	-	-	-	-	-	-	-
22.0 µF	622	17.5	41.5	-	-	-	-	-	-	-	-	-	-

Notes

- Pitch = L + 3.5
- ⁽¹⁾ Not suitable for mains applications
- ⁽²⁾ For the smaller size please add "-M" at the end of the type designation (e.g. MKT 1813-510/255-M)

RECOMMENDED PACKAGING

PACKAGING CODE	TYPE OF PACKAGING	REEL DIAMETER (mm)	ORDERING CODE EXAMPLES	
G	AMMO	-	MKT 1813-422-014-G	x
R	REEL	350	MKT 1813-422-014-R	x
-	BULK	-	MKT 1813-422-014	x

Note

- Attention: Capacitors with L > 31.5 mm only as bulk available

EXAMPLE OF ORDERING CODE

TYPE	CAPACITANCE CODE	VOLTAGE CODE	TOLERANCE CODE ⁽¹⁾	PACKAGING CODE
MKT 1813	410	06	5	G

Note

- ⁽¹⁾ **Tolerance Codes:** 4 = 5 % (J); 5 = 10 % (K); 6 = 20 % (M)

MOUNTING
Normal Use

The capacitors are designed for mounting on printed-circuit boards. The capacitors packed in bandoliers are designed for mounting in printed-circuit boards by means of automatic insertion machines.

For detailed tape specifications refer to Packaging information: www.vishay.com/docs/28139/packinfo.pdf or end of catalogue.

Specific Method of Mounting to Withstand Vibration and Shock

In order to withstand vibration and shock tests, it must be ensured that the capacitor body is in good contact with the printed-circuit board:

- For L ≤ 19 mm capacitors shall be mechanically fixed by the leads
- For larger pitches the capacitors shall be mounted in the same way and the body clamped
- The maximum diameter and length of the capacitors are specified in the dimensions table
- Eccentricity as shown in the drawing below

Space Requirements On Printed-Circuit Board

The maximum length and width of film capacitors is shown in the drawing:

- Eccentricity as in drawing. The maximum eccentricity is smaller than or equal to the lead diameter of the product concerned.
- Product height with seating plane as given by "IEC 60717" as reference: $h_{max.} \leq h + 0.4 \text{ mm}$ or $h_{max.} \leq h' + 0.4 \text{ mm}$

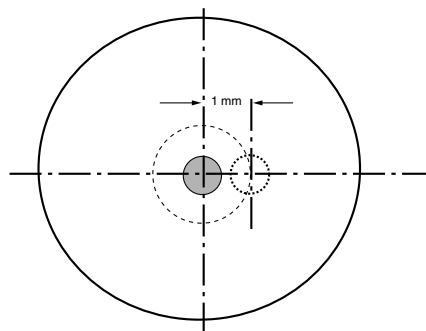
Storage Temperature

- Storage temperature: $T_{stg} = -25 \text{ }^{\circ}\text{C}$ to $+40 \text{ }^{\circ}\text{C}$ with RH maximum 80 % without condensation

Ratings and Characteristics Reference Conditions

Unless otherwise specified, all electrical values apply to an ambient temperature of $23 \pm 1 \text{ }^{\circ}\text{C}$, an atmospheric pressure of 86 kPa to 106 kPa and a relative humidity of $50 \pm 2 \text{ }%$.

For reference testing, a conditioning period shall be applied over $96 \pm 4 \text{ h}$ by heating the products in a circulating air oven at the rated temperature and a relative humidity not exceeding 20 %.

CHARACTERISTICS

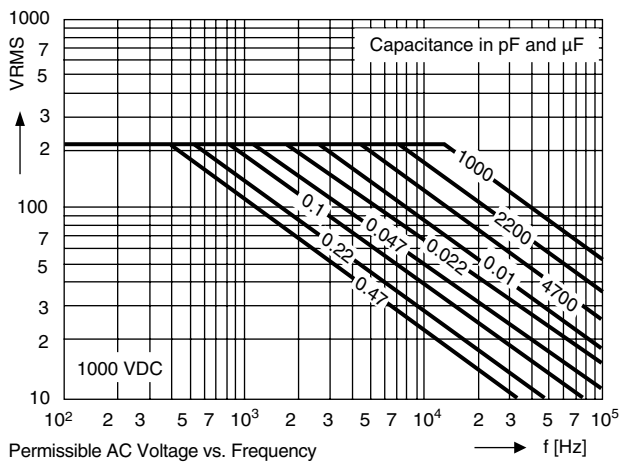
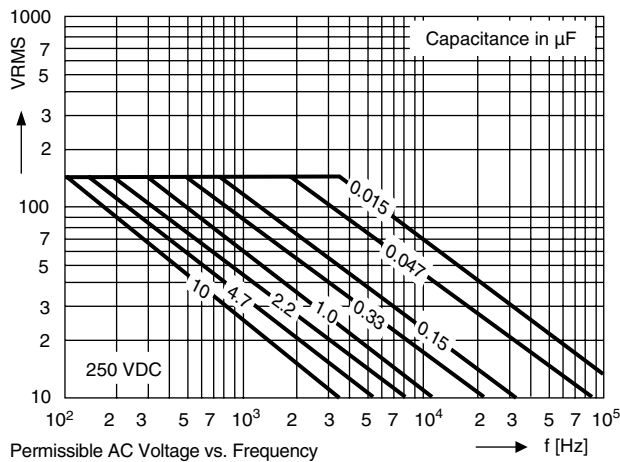
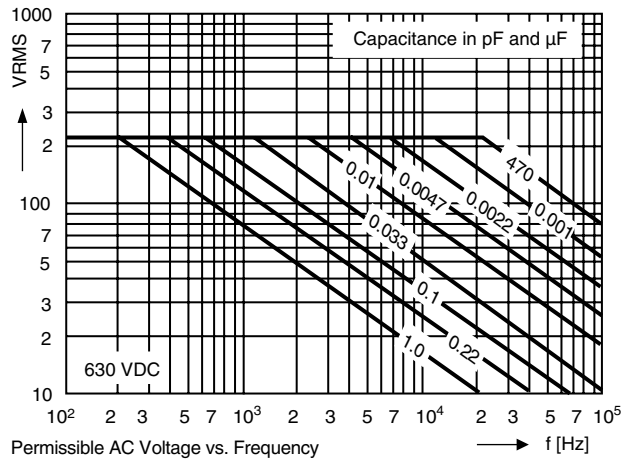
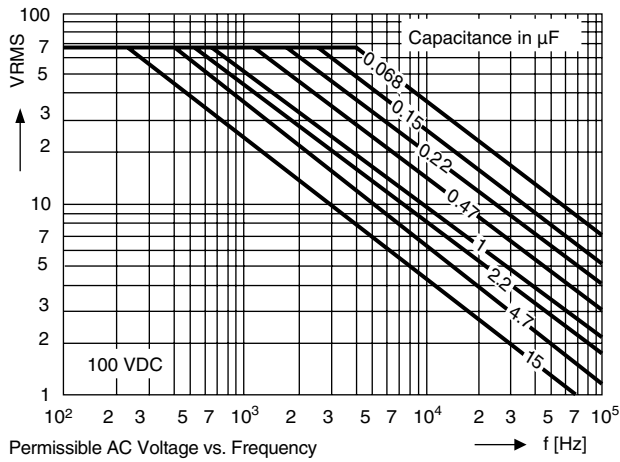
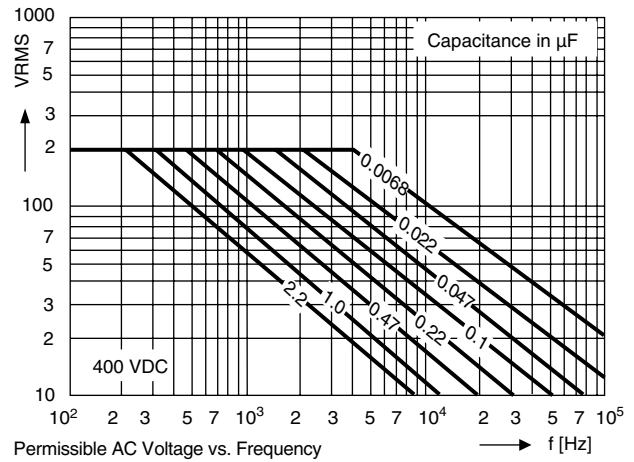
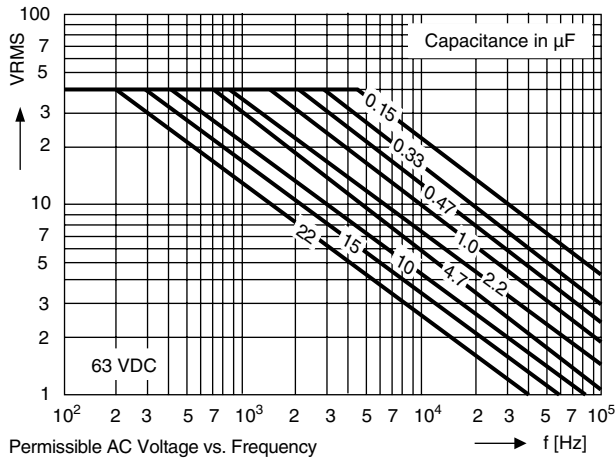



Metallized Polyester Film Capacitor Vishay BCcomponents
MKT Axial Type

Nominal voltage (AC and DC) as a function of temperature
 $U = f(T_A), T_{LL} \leq T_A \leq T_{UL}$

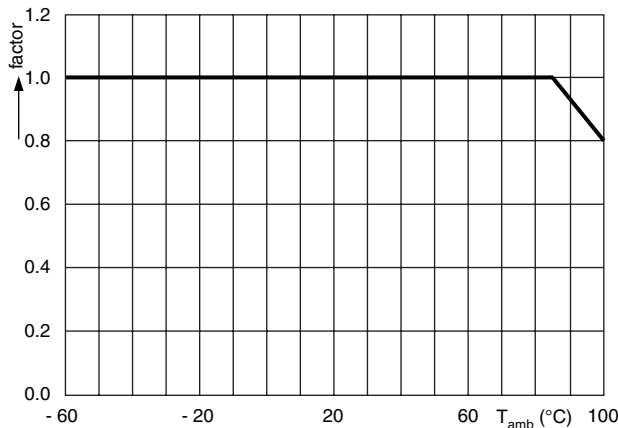

Capacitance as a function of temperature
 $\Delta C/C = f(T_A), T_{LL} \leq T_A \leq T_{UL}$

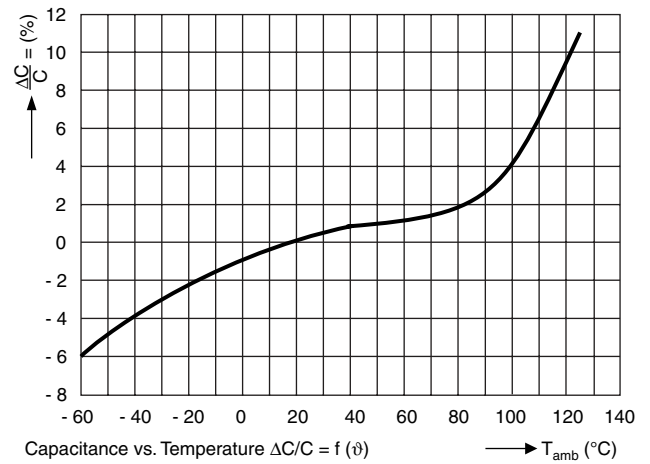

Capacitance as function of frequency
 $\Delta C/C = f(f), 100 \text{ Hz} \leq f \leq 1 \text{ MHz}$

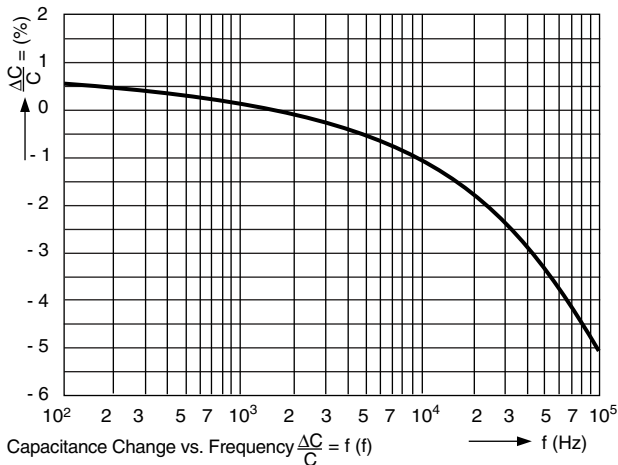

Dissipation factor as function of temperature
 $\Delta \tan \delta / \tan \delta = f(T_A), T_{LL} \leq T_A \leq T_{UL}$

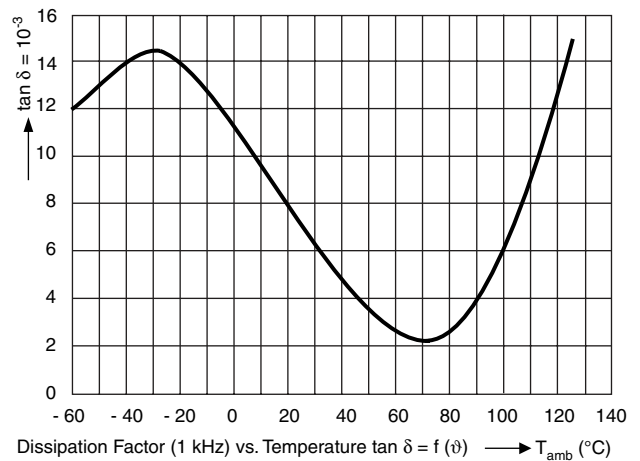

Insulation resistance as a function of temperature
 $R_{is} = f(T_A), T_{LL} \leq T_A \leq T_{UL}$

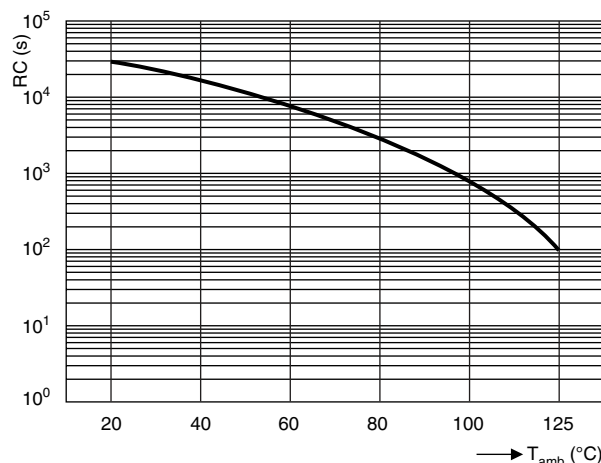

Dissipation factor as a function of frequency
 $\Delta \tan \delta / \tan \delta = f(f), 100 \text{ Hz} \leq f \leq 1 \text{ MHz}_L$

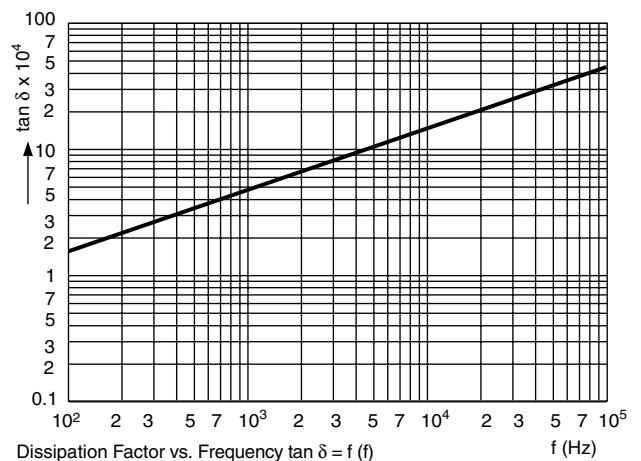

HEAT CONDUCTIVITY (G) AS A FUNCTION OF (ORIGINAL) PITCH AND CAPACITOR BODY THICKNESS IN mW/°C

W _{max.} (mm)	HEAT CONDUCTIVITY (mW/°C)					
	PITCH 11 mm	PITCH 14 mm	PITCH 19 mm	PITCH 26.5 mm	PITCH 31.5 mm	PITCH 41.5 mm
5.0	2	-	-	-	-	-
5.5	2	3	-	-	-	-
6.0	-	3	4	-	-	-
6.5	-	3	5	-	-	-
7.0	-	4	5	-	-	-
7.5	-	-	6	-	-	-
8.0	-	4	-	8	-	-
8.5	-	-	6	9	-	-
9.0	-	-	7	-	-	-
9.5	-	-	-	10	-	-
10.0	-	-	-	11	-	-
10.5	-	-	8	-	-	-
11.0	-	-	-	12	14	-
11.5	-	-	-	13	15	-
12.0	-	-	9	-	16	-
12.5	-	-	-	-	-	-
13.0	-	-	-	14	17	-
13.5	-	-	-	15	18	-
14.0	-	-	-	16	19	-
14.5	-	-	-	-	19	-
15.0	-	-	-	-	-	-
15.5	-	-	-	-	21	-
16.0	-	-	-	-	-	29
16.5	-	-	-	-	22	30
17.0	-	-	-	-	-	-
17.5	-	-	-	-	-	31
18.0	-	-	-	-	24	-
18.5	-	-	-	-	-	-
19.0	-	-	-	-	-	34
20.0	-	-	-	-	-	-
20.5	-	-	-	-	28	-
21.0	-	-	-	-	-	38

POWER DISSIPATION AND MAXIMUM COMPONENT TEMPERATURE RISE

The power dissipation must be limited in order not to exceed the maximum allowed component temperature rise as a function of the free ambient temperature.

The power dissipation can be calculated according type detail specification “HQN-384-01/101: Technical Information Film Capacitors”.

The component temperature rise (ΔT) can be measured (see section “Measuring the component temperature” for more details) or calculated by $\Delta T = P/G$:

- ΔT = Component temperature rise ($^{\circ}\text{C}$)
- P = Power dissipation of the component (mW)
- G = Heat conductivity of the component (mW/ $^{\circ}\text{C}$)

MEASURING THE COMPONENT TEMPERATURE

A thermocouple must be attached to the capacitor body as in:

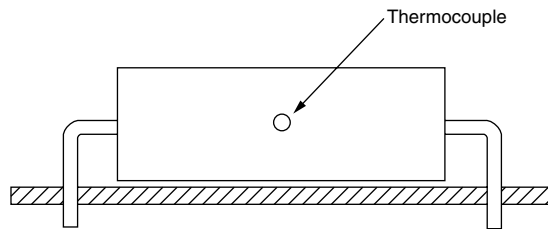

The temperature is measured in unloaded (T_{amb}) and maximum loaded condition (T_{C}).

The temperature rise is given by $\Delta T = T_{\text{C}} - T_{\text{amb}}$.

To avoid radiation or convection, the capacitor should be tested in a wind-free box.

APPLICATION NOTE AND LIMITING CONDITIONS

These capacitors are not suitable for mains applications as across-the-line capacitors without additional protection, as described hereunder. These mains applications are strictly regulated in safety standards and therefore electromagnetic interference suppression capacitors conforming the standards must be used.

To select the capacitor for a certain application, the following conditions must be checked:

1. The peak voltage (U_{P}) shall not be greater than the rated DC voltage (U_{Rdc})
2. The peak-to-peak voltage ($U_{\text{P-P}}$) shall not be greater than $2\sqrt{2} \times U_{\text{Rac}}$ to avoid the ionisation inception level
3. The voltage peak slope (dU/dt) shall not exceed the rated voltage pulse slope in an RC-circuit at rated voltage and without ringing. If the pulse voltage is lower than the rated DC voltage, the rated voltage pulse slope may be multiplied by U_{Rdc} and divided by the applied voltage.

For all other pulses following equation must be fulfilled:

$$2 \times \int_0^T \left(\frac{dU}{dt} \right)^2 \times dt < U_{\text{Rdc}} \times \left(\frac{dU}{dt} \right)_{\text{rated}}$$

T is the pulse duration

The rated voltage pulse slope is valid for ambient temperatures up to 85°C . For higher temperatures a derating factor of 3 % per K shall be applied.

4. The maximum component surface temperature rise must be lower than the limits (see figure max. allowed component temperature rise).

- Since in circuits used at voltages over 280 V peak-to-peak the risk for an intrinsically active flammability after a capacitor breakdown (short circuit) increases, it is recommended that the power to the component is limited to 100 times the values mentioned in the table: "Heat conductivity"
- When using these capacitors as across-the-line capacitor in the input filter for mains applications or as series connected with an impedance to the mains the applicant must guarantee that the following conditions are fulfilled in any case (spikes and surge voltages from the mains included).

Voltage Conditions for 6 Above

ALLOWED VOLTAGES	$T_{amb} \leq 85\text{ }^{\circ}\text{C}$	$85\text{ }^{\circ}\text{C} < T_{amb} \leq 100\text{ }^{\circ}\text{C}$
Maximum continuous RMS voltage	U_{Rac}	$0.8 \times U_{Rac}$
Maximum temperature RMS-overvoltage (< 24 h)	$1.25 \times U_{Rac}$	U_{Rac}
Maximum peak voltage (V_{O-P}) (< 2 s)	$1.6 \times U_{Rdc}$	$1.3 \times U_{Rdc}$

EXAMPLE

$C = 3300\text{ nF} - 100\text{ V}$ used for the voltage signal shown in next figure.

$U_{P-P} = 80\text{ V}$; $U_P = 70\text{ V}$; $T_1 = 0.5\text{ ms}$; $T_2 = 1\text{ ms}$

The ambient temperature is $35\text{ }^{\circ}\text{C}$

Checking conditions:

- The peak voltage $U_P = 70\text{ V}$ is lower than 100 Vdc
- The peak-to-peak voltage 80 V is lower than $2\sqrt{2} \times 63\text{ Vac} = 178\text{ }U_{P-P}$
- The voltage pulse slope $(dU/dt) = 80\text{ V}/500\text{ }\mu\text{s} = 0.16\text{ V}/\mu\text{s}$
This is lower than $8\text{ V}/\mu\text{s}$ (see specific reference data for each version)
- The dissipated power is 60 mW as calculated with fourier terms
The temperature rise for $W_{max.} = 11.5\text{ mm}$ and pitch = 26.5 mm will be $60\text{ mW}/13\text{ mW}/^{\circ}\text{C} = 4.6\text{ }^{\circ}\text{C}$
This is lower than $15\text{ }^{\circ}\text{C}$ temperature rise at $35\text{ }^{\circ}\text{C}$, according figure max. allowed component temperature rise
- Not applicable
- Not applicable

Voltage Signal

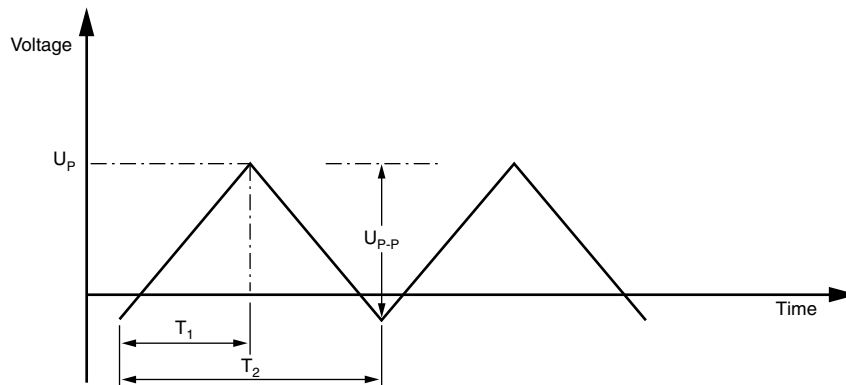



Metallized Polyester Film Capacitor Vishay BCcomponents
MKT Axial Type

INSPECTION REQUIREMENTS

General Notes:

Sub-clause numbers of tests and performance requirements refer to the “Sectional Specification, publication IEC 60384-2 and Specific Reference Data”.

Group C Inspection Requirements

SUB-CLAUSE NUMBER AND TEST	CONDITIONS	PERFORMANCE REQUIREMENTS
SUB-GROUP C1A PART OF SAMPLE OF SUB-GROUP C1		
4.1 Dimensions (detail)		As specified in Chapters “General data” of this specification
4.3.1 Initial measurements	Capacitance Tangent of loss angle: For C ≤ 470 nF at 100 kHz or for C > 470 nF at 10 kHz	
4.3 Robustness of terminations	Tensile: Load 10 N; 10 s Bending: Load 5 N; 4 x 90°	No visible damage
4.4 Resistance to soldering heat	Method: 1A Solder bath: 280 °C ± 5 °C Duration: 10 s	
4.14 Component solvent resistance	Isopropylalcohol at room temperature Method: 2 Immersion time: 5 ± 0.5 min Recovery time: Min. 1 h, max. 2 h	
4.4.2 Final measurements	Visual examination Capacitance Tangent of loss angle	No visible damage Legible marking $ \Delta C/C \leq 2\%$ of the value measured initially Increase of tan δ ≤ 0.005 for: C ≤ 100 nF or ≤ 0.010 for: 100 nF < C ≤ 220 nF or ≤ 0.015 for: 220 nF < C ≤ 470 nF and ≤ 0.003 for: C > 470 nF Compared to values measured in 4.3.1
SUB-GROUP C1B PART OF SAMPLE OF SUB-GROUP C1		
4.6.1 Initial measurements	Capacitance Tangent of loss angle: For C ≤ 470 nF at 100 kHz or for C > 470 nF at 10 kHz	
4.6 Rapid change of temperature	θA = - 55 °C θB = + 100 °C 5 cycles Duration t = 30 min Visual examination	No visible damage
4.7 Vibration	Mounting: See section “Mounting” of this specification Procedure B4 Frequency range: 10 Hz to 55 Hz Amplitude: 0.75 mm or Acceleration 98 m/s ² (whichever is less severe) Total duration 6 h	
4.7.2 Final inspection	Visual examination	No visible damage

SUB-CLAUSE NUMBER AND TEST	CONDITIONS	PERFORMANCE REQUIREMENTS
<p>4.9 Shock</p> <p>4.9.3 Final measurements</p>	<p>Mounting: See section "Mounting" of this specification Pulse shape: Half sine Acceleration: 490 m/s² Duration of pulse: 11 ms</p> <p>Visual examination</p> <p>Capacitance</p> <p>Tangent of loss angle</p> <p>Insulation resistance</p>	<p>No visible damage</p> <p>$\Delta C/C \leq 3\%$ of the value measured in 4.6.1</p> <p>Increase of $\tan \delta$</p> <p>≤ 0.005 for: C ≤ 100 nF or ≤ 0.010 for: 100 nF < C ≤ 220 nF or ≤ 0.015 for: 220 nF < C ≤ 470 nF and ≤ 0.003 for: C > 470 nF</p> <p>Compared to values measured in 4.6.1</p> <p>As specified in section "Insulation Resistance" of this specification</p>
<p>SUB-GROUP C1 COMBINED SAMPLE OF SPECIMENS OF SUB-GROUPS C1A AND C1B</p>		
<p>4.10 Climatic sequence</p> <p>4.10.2 Dry heat</p> <p>4.10.3 Damp heat cyclic Test Db, first cycle</p> <p>4.10.4 Cold</p> <p>4.10.6 Damp heat cyclic Test Db, remaining cycles</p> <p>4.10.6.2 Final measurements</p>	<p>Temperature: + 100 °C Duration: 16 h</p> <p>Temperature: - 55 °C Duration: 2 h</p> <p>Voltage proof = U_{Rdc} for 1 min within 15 min after removal from testchamber</p> <p>Visual examination</p> <p>Capacitance</p> <p>Tangent of loss angle</p> <p>Insulation resistance</p>	<p>No breakdown of flash-over</p> <p>No visible damage</p> <p>Legible marking</p> <p>$\Delta C/C \leq 5\%$ of the value measured in 4.4.2 or 4.9.3</p> <p>Increase of $\tan \delta$</p> <p>≤ 0.007 for: C ≤ 100 nF or ≤ 0.010 for: 100 nF < C ≤ 220 nF or ≤ 0.015 for: 220 nF < C ≤ 470 nF and ≤ 0.005 for: C > 470 nF</p> <p>Compared to values measured in 4.3.1 or 4.6.1</p> <p>$\geq 50\%$ of values specified in section "Insulation resistance" of this specification</p>
<p>SUB-GROUP C2</p>		
<p>4.11 Damp heat steady state</p> <p>4.11.1 Initial measurements</p>	<p>56 days, 40 °C, 90 % to 95 % RH</p> <p>Capacitance</p> <p>Tangent of loss angle at 1 kHz</p>	



Metallized Polyester Film Capacitor Vishay BCcomponents
MKT Axial Type

SUB-CLAUSE NUMBER AND TEST	CONDITIONS	PERFORMANCE REQUIREMENTS
4.11.3 Final measurements	Voltage proof = U_{Rdc} for 1 min within 15 min after removal from testchamber Visual examination Capacitance Tangent of loss angle Insulation resistance	No breakdown of flash-over No visible damage Legible marking $ \Delta C/C \leq 5\%$ of the value measured in 4.11.1. Increase of $\tan \delta \leq 0.005$ Compared to values measured in 4.11.1 $\geq 50\%$ of values specified in section "Insulation resistance" of this specification
SUB-GROUP C3		
4.12 Endurance 4.12.1 Initial measurements 4.12.5 Final measurements	Duration: 2000 h 1.25 x U_{Rdc} at 85 °C 1.0 x U_{Rdc} at 100 °C Capacitance Tangent of loss angle: For $C \leq 470$ nF at 100 kHz or for $C > 470$ nF at 10 kHz Visual examination Capacitance Tangent of loss angle Insulation resistance	No visible damage Legible marking $ \Delta C/C \leq 5\%$ compared to values measured in 4.12.1 Increase of $\tan \delta$ ≤ 0.005 for: C ≤ 100 nF or ≤ 0.010 for: 100 nF < C ≤ 220 nF or ≤ 0.015 for: 220 nF < C ≤ 470 nF and ≤ 0.003 for: C > 470 nF Compared to values measured in 4.12.1 $\geq 50\%$ of values specified in section "Insulation resistance" of this specification
SUB-GROUP C4		
4.13 Charge and discharge 4.13.1 Initial measurements 4.13.3 Final measurements	10 000 cycles Charged to U_{Rdc} Discharge resistance: $R = \frac{U_R}{C \times 2.5 \times (dU/dt)_R}$ Capacitance Tangent of loss angle: For $C \leq 470$ nF at 100 kHz or for $C > 470$ nF at 10 kHz Capacitance Tangent of loss angle Insulation resistance	$ \Delta C/C \leq 3\%$ compared to values measured in 4.13.1 Increase of $\tan \delta$ ≤ 0.005 for: C ≤ 100 nF or ≤ 0.010 for: 100 nF < C ≤ 220 nF or ≤ 0.015 for: 220 nF < C ≤ 470 nF and ≤ 0.003 for: C > 470 nF Compared to values measured in 4.13.1 $\geq 50\%$ of values specified in section "Insulation resistance" of this specification



Disclaimer

All product specifications and data are subject to change without notice.

Vishay Intertechnology, Inc., its affiliates, agents, and employees, and all persons acting on its or their behalf (collectively, "Vishay"), disclaim any and all liability for any errors, inaccuracies or incompleteness contained herein or in any other disclosure relating to any product.

Vishay disclaims any and all liability arising out of the use or application of any product described herein or of any information provided herein to the maximum extent permitted by law. The product specifications do not expand or otherwise modify Vishay's terms and conditions of purchase, including but not limited to the warranty expressed therein, which apply to these products.

No license, express or implied, by estoppel or otherwise, to any intellectual property rights is granted by this document or by any conduct of Vishay.

The products shown herein are not designed for use in medical, life-saving, or life-sustaining applications unless otherwise expressly indicated. Customers using or selling Vishay products not expressly indicated for use in such applications do so entirely at their own risk and agree to fully indemnify Vishay for any damages arising or resulting from such use or sale. Please contact authorized Vishay personnel to obtain written terms and conditions regarding products designed for such applications.

Product names and markings noted herein may be trademarks of their respective owners.