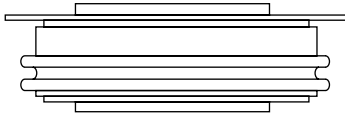

Fast Recovery Diodes (Hockey PUK Version), 600 A

B-43
FEATURES

- High power FAST recovery diode series
- 1.0 to 2.0 μ s recovery time
- High voltage ratings up to 2200 V
- High current capability
- Optimized turn-on and turn-off characteristics
- Low forward recovery
- Fast and soft reverse recovery
- Press PUK encapsulation
- Case style conform to JEDEC B-43
- Maximum junction temperature 125 °C
- Lead (Pb)-free
- Designed and qualified for industrial level

**RoHS
COMPLIANT**
PRODUCT SUMMARY

$I_{F(AV)}$	600 A
-------------	-------

TYPICAL APPLICATIONS

- Snubber diode for GTO
- High voltage freewheeling diode
- Fast recovery rectifier applications

MAJOR RATINGS AND CHARACTERISTICS

PARAMETER	TEST CONDITIONS	VALUES	UNITS
$I_{F(AV)}$		600	A
	T_{hs}	55	°C
$I_{F(RMS)}$		942	A
	T_{hs}	25	°C
I_{FSM}	50 Hz	8320	A
	60 Hz	8715	
I^2t	50 Hz	346	kA ² s
	60 Hz	316	
V_{RRM}	Range	400 to 2200	V
t_{rr}		1.0 to 2.0	μ s
	T_J	25	°C
T_J		- 40 to 125	

ELECTRICAL SPECIFICATIONS

VOLTAGE RATINGS				
TYPE NUMBER	VOLTAGE CODE	V _{RRM} , MAXIMUM REPETITIVE PEAK AND OFF-STATE VOLTAGE V	V _{RSM} , MAXIMUM NON-REPETITIVE PEAK VOLTAGE V	I _{RRM} MAXIMUM AT T _J = 125 °C mA
SD603C..S10C	04	400	500	45
	08	800	900	
	10	1000	1100	
SD603C..S15C	12	1200	1300	
	14	1400	1500	
	16	1600	1700	
SD603C..S20C	20	2000	2100	
	22	2200	2300	

FORWARD CONDUCTION					
PARAMETER	SYMBOL	TEST CONDITIONS		VALUES	UNITS
Maximum average forward current at heatsink temperature	I _{F(AV)}	180° conduction, half sine wave Double side (single side) cooled		600 (300)	A
				55 (75)	°C
Maximum RMS current	I _{F(RMS)}	25 °C heatsink temperature double side cooled		942	A
Maximum peak, one-cycle non-repetitive forward current	I _{FSM}	t = 10 ms	No voltage reappplied	8320	
		t = 8.3 ms		8715	
		t = 10 ms	100 % V _{RRM} reappplied	7000	
		t = 8.3 ms		7330	
Maximum I ² t for fusing	I ² t	t = 10 ms	No voltage reappplied	346	kA ² s
		t = 8.3 ms		316	
		t = 10 ms	100 % V _{RRM} reappplied	245	
		t = 8.3 ms		224	
Maximum I ² √t for fusing	I ² √t	t = 0.1 to 10 ms, no voltage reappplied		3460	kA ² /s
Low level value of threshold voltage	V _{F(TO)1}	(16.7 % × π × I _{F(AV)}) < I < π × I _{F(AV)} , T _J = T _J maximum		1.36	V
High level value of threshold voltage	V _{F(TO)2}	(I > π × I _{F(AV)}), T _J = T _J maximum		1.81	
Low level of forward slope resistance	r _{f1}	(16.7 % × π × I _{F(AV)}) < I < π × I _{F(AV)} , T _J = T _J maximum		0.87	mΩ
High level of forward slope resistance	r _{f2}	(I > π × I _{F(AV)}), T _J = T _J maximum		0.67	
Maximum forward voltage drop	V _{FM}	I _{pk} = 1885 A, T _J = 25 °C; t _p = 10 ms sinusoidal wave		2.97	V

RECOVERY CHARACTERISTICS								
CODE	MAXIMUM VALUE AT T _J = 25 °C	TEST CONDITIONS			TYPICAL VALUES AT T _J = 125 °C			
	t _{rr} AT 25 % I _{RRM} (μs)	I _{pk} SQUARE PULSE (A)	di/dt (A/μs)	V _r (V)	t _{rr} AT 25 % I _{RRM} (μs)	Q _{rr} (μC)	I _{rr} (A)	
S10	1.0	1000	25	- 30	2.0	45	34	
S15	1.5				3.2	87	51	
S20	2.0				3.5	97	55	



THERMAL AND MECHANICAL SPECIFICATIONS				
PARAMETER	SYMBOL	TEST CONDITIONS	VALUES	UNITS
Maximum operating junction temperature range	T_J		- 40 to 125	°C
Maximum storage temperature range	T_{Stg}		- 40 to 150	
Maximum thermal resistance, junction to heatsink	R_{thJ-hs}	DC operation single side cooled	0.076	K/W
		DC operation double side cooled	0.038	
Mounting force, $\pm 10\%$			9800 (1000)	N (kg)
Approximate weight			83	g
Case style		See dimensions - link at the end of datasheet	B-43	

ΔR_{thJ-hs} CONDUCTION						
CONDUCTION ANGLE	SINUSOIDAL CONDUCTION		RECTANGULAR CONDUCTION		TEST CONDITIONS	UNITS
	SINGLE SIDE	DOUBLE SIDE	SINGLE SIDE	DOUBLE SIDE		
180°	0.006	0.007	0.005	0.005	$T_J = T_J$ maximum	K/W
120°	0.008	0.008	0.008	0.008		
90°	0.010	0.010	0.011	0.011		
60°	0.015	0.015	0.016	0.015		
30°	0.026	0.025	0.026	0.025		

Note

- The table above shows the increment of thermal resistance R_{thJ-hs} when devices operate at different conduction angles than DC

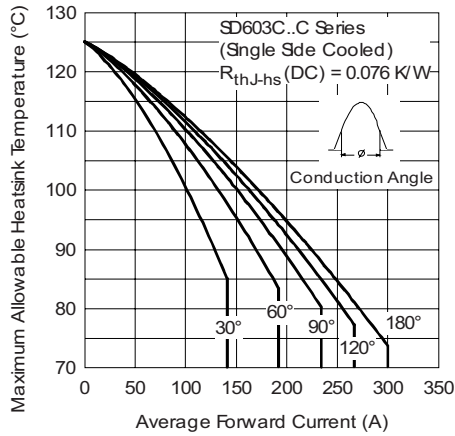

Fig. 1 - Current Ratings Characteristics

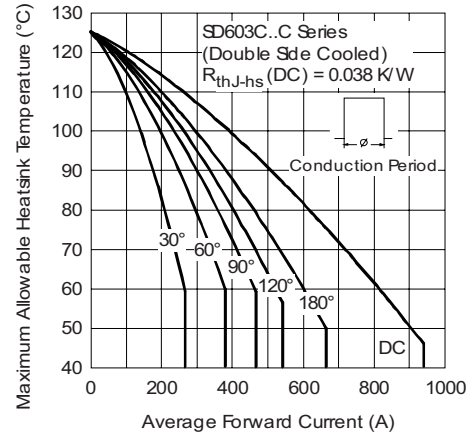

Fig. 4 - Current Ratings Characteristics

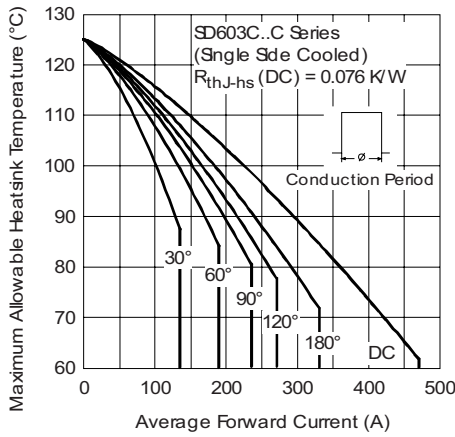

Fig. 2 - Current Ratings Characteristics

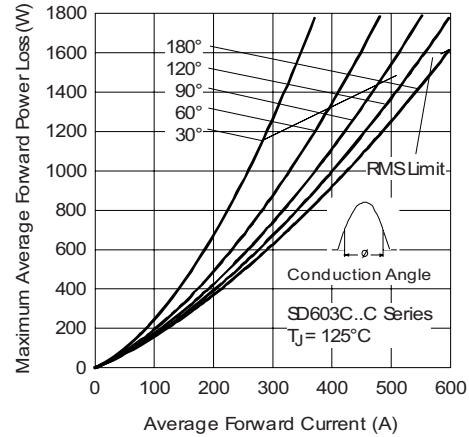

Fig. 5 - Forward Power Loss Characteristics

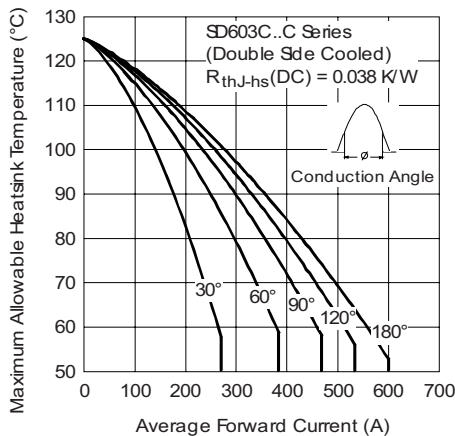

Fig. 3 - Current Ratings Characteristics

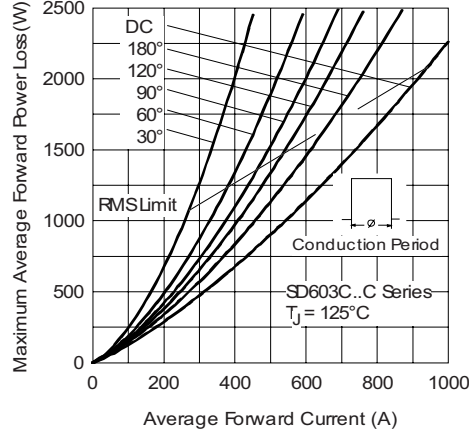

Fig. 6 - Forward Power Loss Characteristics

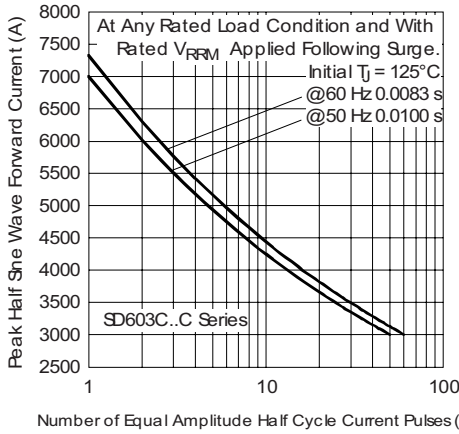

Fig. 7 - Maximum Non-Repetitive Surge Current Single and Double Side Cooled

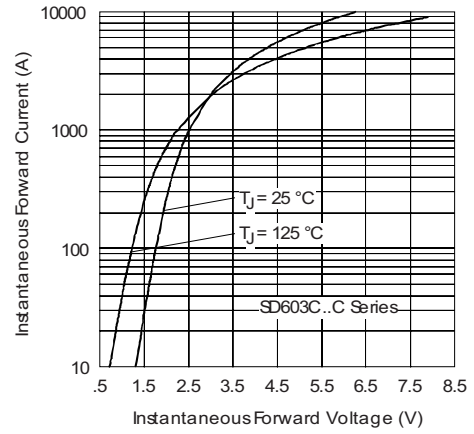

Fig. 9 - Forward Voltage Drop Characteristics

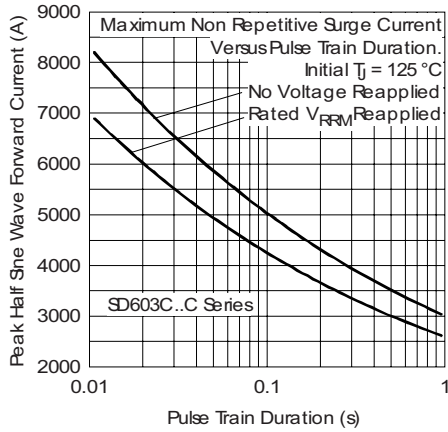

Fig. 8 - Maximum Non-Repetitive Surge Current Single and Double Side Cooled

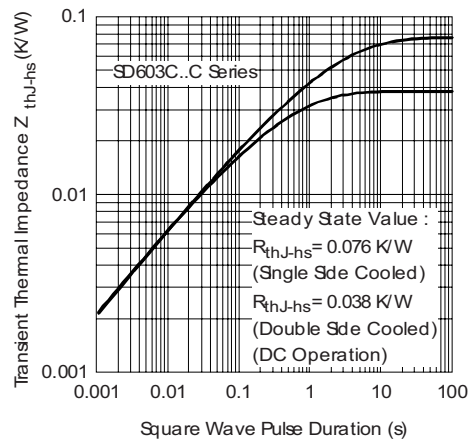

Fig. 10 - Thermal Impedance Z_{thJ-hs} Characteristics

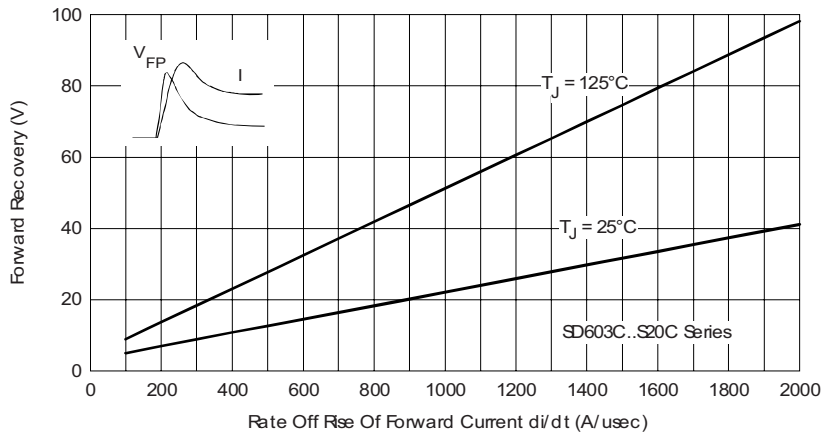

Fig. 11 - Typical Forward Recovery Characteristics

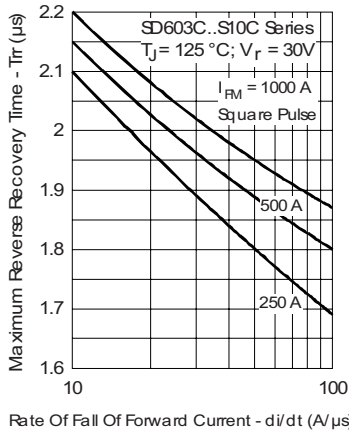

Fig. 12 - Recovery Time Characteristics

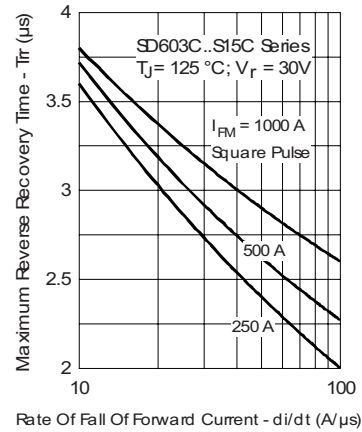

Fig. 15 - Recovery Time Characteristics

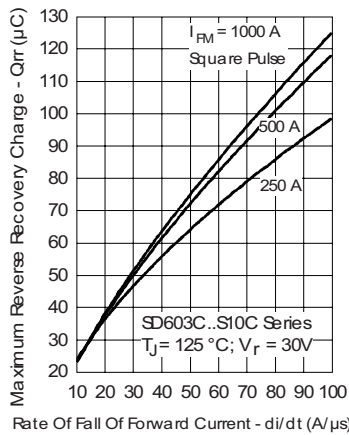

Fig. 13 - Recovery Charge Characteristics

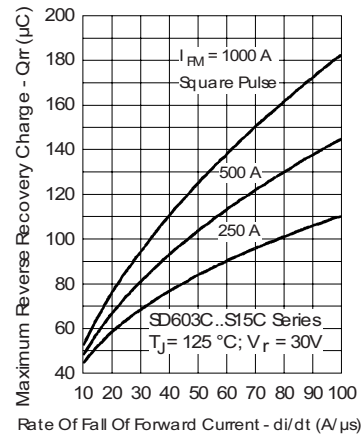

Fig. 16 - Recovery Charge Characteristics

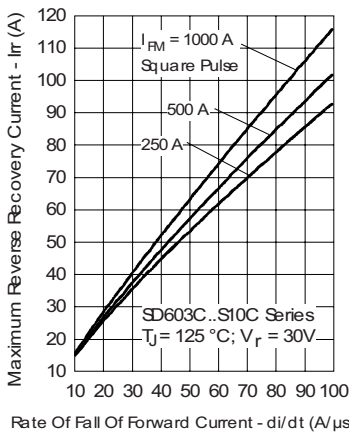

Fig. 14 - Recovery Current Characteristics

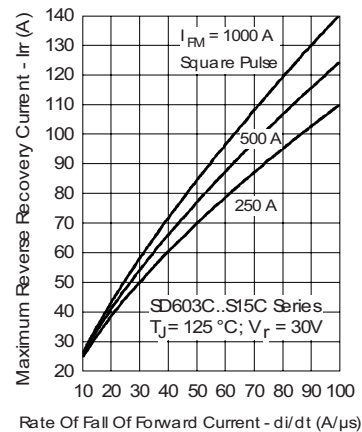

Fig. 17 - Recovery Current Characteristics

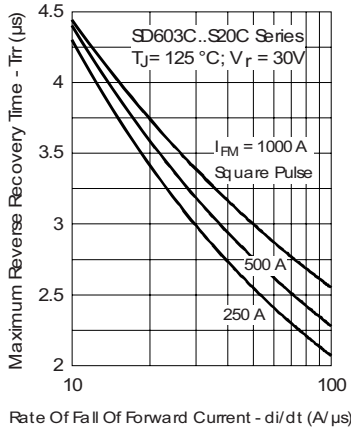

Fig. 18 - Recovery Time Characteristics

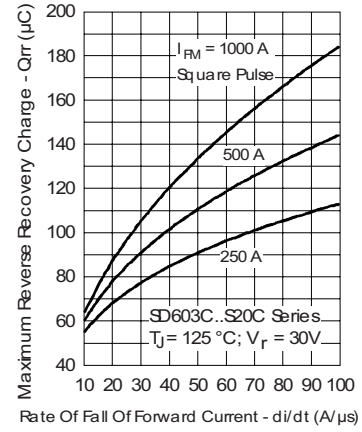

Fig. 19 - Recovery Charge Characteristics

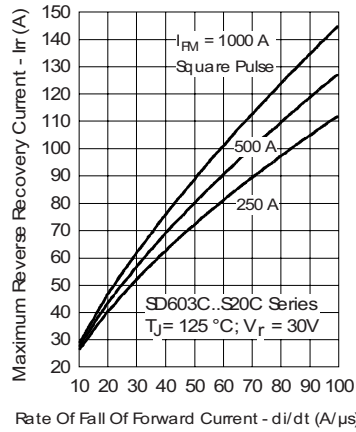

Fig. 20 - Recovery Current Characteristics

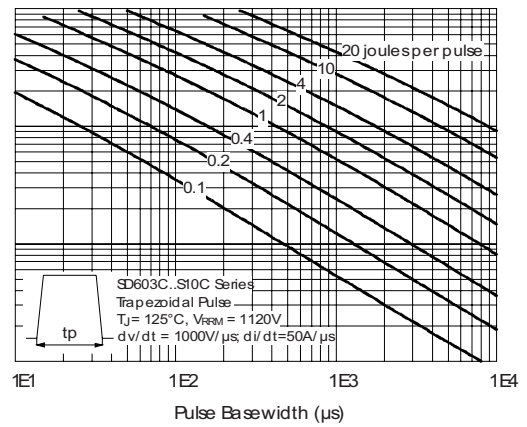
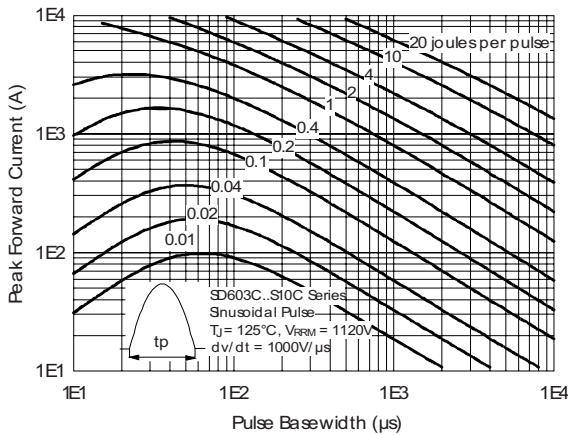

Fig. 21 - Maximum Total Energy Loss Per Pulse Characteristics

SD603C..C Series

Vishay High Power Products Fast Recovery Diodes
(Hockey PUK Version), 600 A

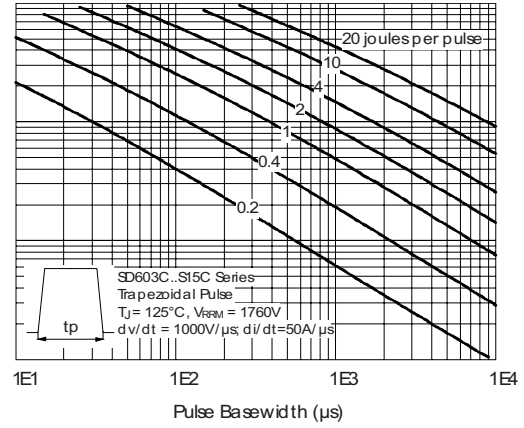
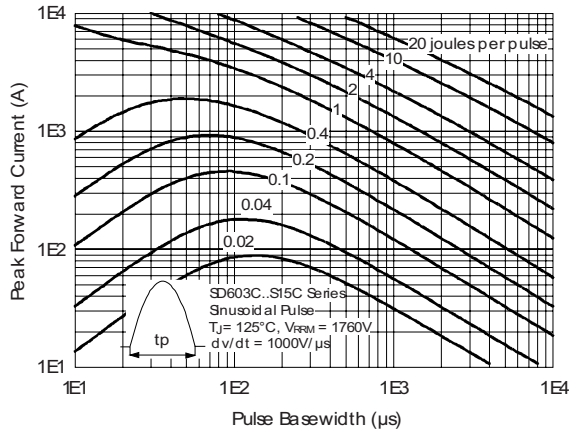

Fig. 22 - Maximum Total Energy Loss Per Pulse Characteristics

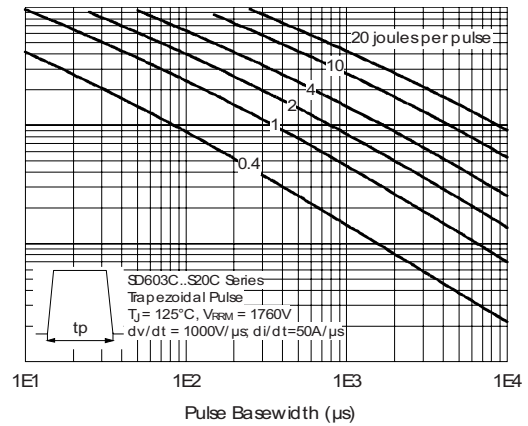
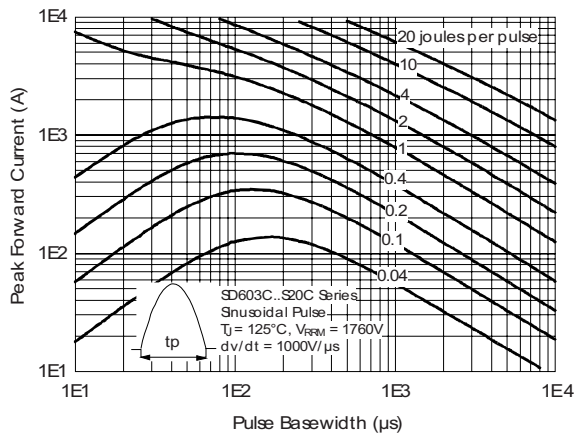
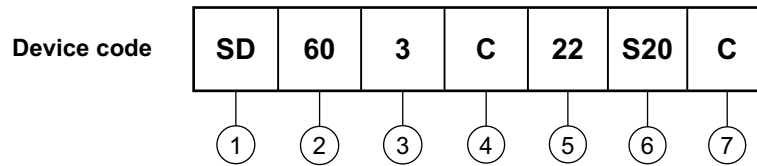

Fig. 23 - Maximum Total Energy Loss Per Pulse Characteristics



ORDERING INFORMATION TABLE



- 1** - Diode
- 2** - Essential part number
- 3** - 3 = Fast recovery
- 4** - C = Ceramic PUK
- 5** - Voltage code x 100 = V_{RRM} (see Voltage Ratings table)
- 6** - t_{rr} code (see Recovery Characteristics table)
- 7** - C = PUK case B-43

LINKS TO RELATED DOCUMENTS	
Dimensions	http://www.vishay.com/doc?95249



Disclaimer

All product specifications and data are subject to change without notice.

Vishay Intertechnology, Inc., its affiliates, agents, and employees, and all persons acting on its or their behalf (collectively, "Vishay"), disclaim any and all liability for any errors, inaccuracies or incompleteness contained herein or in any other disclosure relating to any product.

Vishay disclaims any and all liability arising out of the use or application of any product described herein or of any information provided herein to the maximum extent permitted by law. The product specifications do not expand or otherwise modify Vishay's terms and conditions of purchase, including but not limited to the warranty expressed therein, which apply to these products.

No license, express or implied, by estoppel or otherwise, to any intellectual property rights is granted by this document or by any conduct of Vishay.

The products shown herein are not designed for use in medical, life-saving, or life-sustaining applications unless otherwise expressly indicated. Customers using or selling Vishay products not expressly indicated for use in such applications do so entirely at their own risk and agree to fully indemnify Vishay for any damages arising or resulting from such use or sale. Please contact authorized Vishay personnel to obtain written terms and conditions regarding products designed for such applications.

Product names and markings noted herein may be trademarks of their respective owners.