

Active Lowpass Filter

KR Model
2364

Specifications

KR Part Number	2364
Filter Type	5 Hz Active Lowpass Filter
Approximate -3 dB Frequency	5 Hz
Attenuation at 16 Hz and above	> 40 dB
Gain	0 dB \pm 0.1 dB
Supply Voltage	\pm 15 V
Supply Current	7 mA max
Operating Temperature	0° C to 70° C
Storage Temperature	0° C to 70° C

Outline Drawing

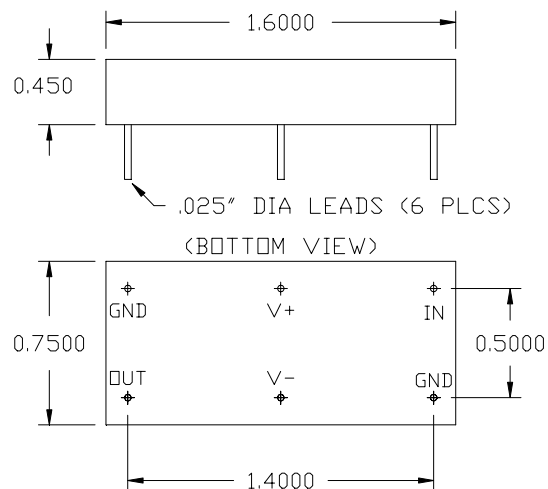

Epoxy Package

All Dimensions inches

Connect both ground pins to ground plane

KR Electronics
www.krfilters.com
91 Avenel Street
Avenel, NJ 07001
732-636-1900