

N- AND P-CHANNEL ENHANCEMENT MODE POWER MOSFET

MTC4503Q8

Description

The MTC4503Q8 consists of a N-channel and a P-channel enhancement-mode MOSFET in a single SOP-8 package, providing the designer with the best combination of fast switching, ruggedized device design, low on-resistance and cost-effectiveness.

The SOP-8 package is universally preferred for all commercial-industrial surface mount applications and suited for low voltage applications such as DC/DC converters.

Features

- Simple drive requirement
- Low on-resistance
- Fast switching speed
- Pb-free package

Applications

- Power management in notebook computer, portable equipment and battery powered systems.

Equivalent Circuit

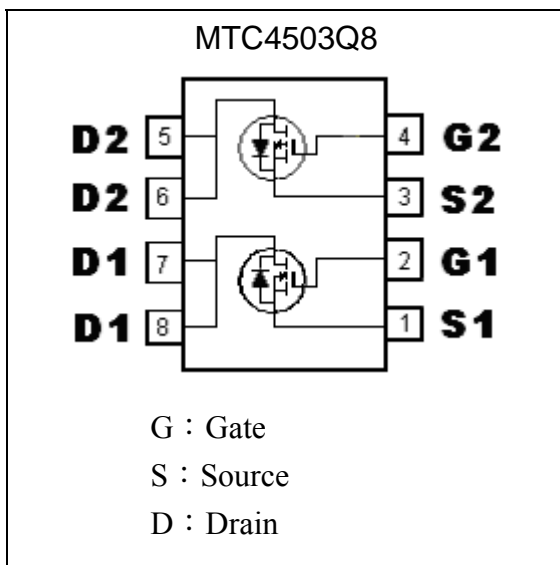

Outline

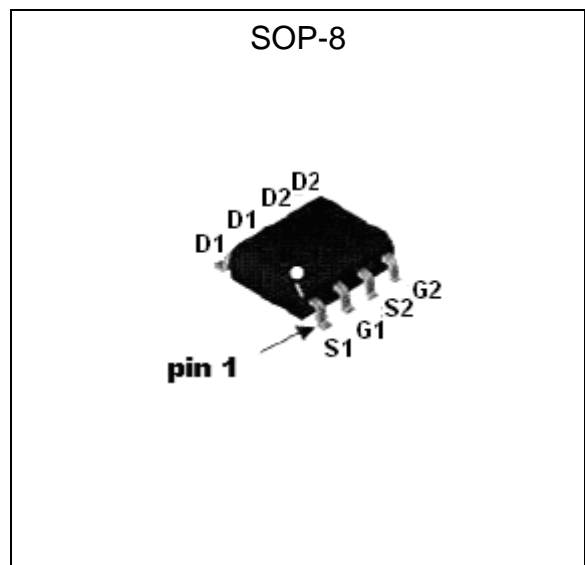



Absolute Maximum Ratings (Ta=25°C)

Parameter	Symbol	Limits		Unit
		N-channel	P-channel	
Drain-Source Breakdown Voltage	BV _{DSS}	30	-30	V
Gate-Source Voltage	V _{GS}	±20	±20	V
Continuous Drain Current @T _A =25 °C (Note 1)	I _D	6.9	-6.3	A
Continuous Drain Current @T _A =70 °C (Note 1)	I _D	5.5	-5.0	A
Pulsed Drain Current (Note 2)	I _{DM}	30	-30	A
Total Power Dissipation (Note 1)	P _d	2		W
Linear Derating Factor		0.016		W / °C
Operating Junction Temperature	T _j	-55~+150		°C
Storage Temperature	T _{stg}	-55~+150		°C
Thermal Resistance, Junction-to-Ambient (Note 1)	R _{th,ja}	62.5		°C/W

Note : 1.Surface mounted on 1 in² copper pad of FR-4 board, 135°C/W when mounted on minimum copper pad
 2.Pulse width limited by maximum junction temperature

N-Channel Electrical Characteristics (T_j=25°C, unless otherwise specified)

Symbol	Min.	Typ.	Max.	Unit	Test Conditions
Static					
BV _{DSS}	30	-	-	V	V _{GS} =0, I _D =250μA
ΔBV _{DSS} /ΔT _j	-	0.005	-	V/°C	Reference to 25°C, I _D =1mA
V _{GS(th)}	1.0	-	3.0	V	V _{DS} =V _{GS} , I _D =250μA
I _{GSS}	-	-	±100	nA	V _{GS} =±20V, V _{DS} =0
I _{DSS}	-	-	1	μA	V _{DS} =30V, V _{GS} =0
I _{DSS}	-	-	25	μA	V _{DS} =24V, V _{GS} =0, T _j =70°C
*R _{DS(ON)}	-	-	28	mΩ	I _D =6A, V _{GS} =10V
	-	-	42		I _D =4A, V _{GS} =4.5V
*G _{FS}	-	5.7	-	S	V _{DS} =10V, I _D =6A
Dynamic					
C _{iss}	-	610	970	pF	V _{DS} =25V, V _{GS} =0, f=1MHz
C _{oss}	-	160	-		
C _{rss}	-	120	-		
*t _{d(ON)}	-	8	-	ns	V _{DS} =15V, I _D =1A, V _{GS} =10V, R _G =3.3Ω, R _D =15Ω
*t _r	-	7	-		
*t _{d(OFF)}	-	19	-		
*t _f	-	6	-		
*Q _g	-	9	15	nC	V _{DS} =24V, I _D =6A, V _{GS} =4.5V
*Q _{gs}	-	2	-		
*Q _{gd}	-	6	-		
Source-Drain Diode					
*V _{SD}	-	-	1.2	V	V _{GS} =0V, I _S =6A
*t _{rr}	-	18	-	ns	I _S =6A, V _{GS} =0V, dI/dt=100A/μs
*Q _{rr}	-	11	-	nC	

*Pulse Test : Pulse Width ≤300μs, Duty Cycle ≤2%



P-Channel Electrical Characteristics (Tj=25°C, unless otherwise specified)

Symbol	Min.	Typ.	Max.	Unit	Test Conditions
Static					
BV _{DSS}	-30	-	-	V	V _{GS} =0, I _D =-250μA
ΔBV _{DSS} /ΔT _j	-	-0.004	-	V/°C	Reference to 25°C, I _D =-1mA
V _{GS(th)}	-1.0	-	-3.0	V	V _{DS} =V _{GS} , I _D =-250μA
I _{GSS}	-	-	±100	nA	V _{GS} =±20V, V _{DS} =0
I _{DSS}	-	-	-1	μA	V _{DS} =-30V, V _{GS} =0
I _{DSS}	-	-	-25	μA	V _{DS} =-24V, V _{GS} =0, T _j =70°C
*R _{DS(ON)}	-	-	36	mΩ	I _D =-6A, V _{GS} =-10V
	-	-	55		I _D =-4A, V _{GS} =-4.5V
*G _{FS}	-	5.8	-	S	V _{DS} =-10V, I _D =-6A
Dynamic					
C _{iss}	-	960	1540	pF	V _{DS} =-25V, V _{GS} =0, f=1MHz
C _{oss}	-	300	-		
C _{rss}	-	220	-		
*t _{d(ON)}	-	12	-	ns	V _{DS} =-15V, I _D =-1A, V _{GS} =-10V, R _G =3.3Ω, R _D =15Ω
*t _r	-	8	-	ns	
*t _{d(OFF)}	-	42	-	ns	
*t _f	-	34	-	ns	
*Q _g	-	15	24	nC	V _{DS} =-24V, I _D =-6A, V _{GS} =-4.5V
*Q _{gs}	-	3	-	nC	
*Q _{gd}	-	9	-	nC	
Source-Drain Diode					
*V _{SD}	-	-	-1.2	V	V _{GS} =0V, I _S =-6A
*t _{rr}	-	24	-	ns	I _S =-6A, V _{GS} =0V, dI/dt=100A/μs
*Q _{rr}	-	18	-	nC	

*Pulse Test : Pulse Width ≤300μs, Duty Cycle ≤2%

N-channel Characteristic Curves

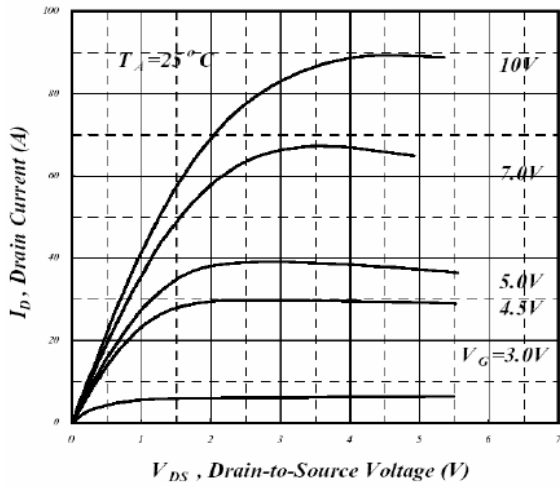

Fig 1. Typical Output Characteristics

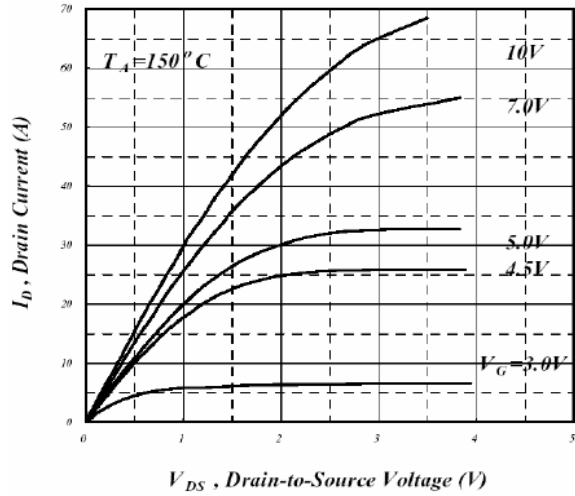

Fig 2. Typical Output Characteristics

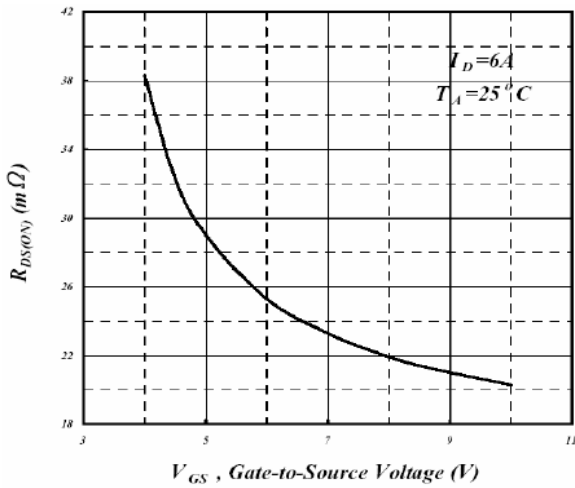

Fig 3. On-Resistance v.s. Gate Voltage

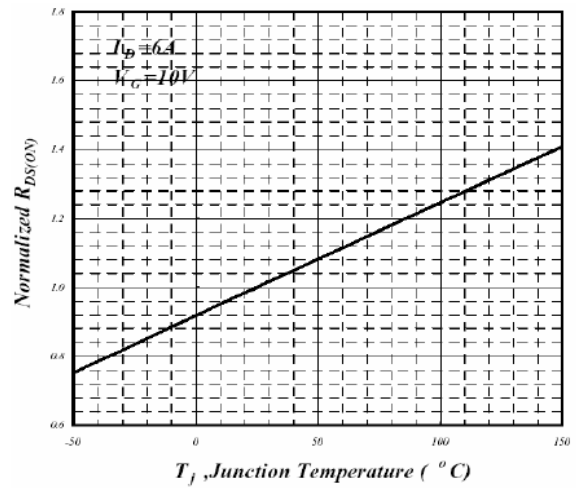

Fig 4. Normalized On-Resistance v.s. Junction Temperature

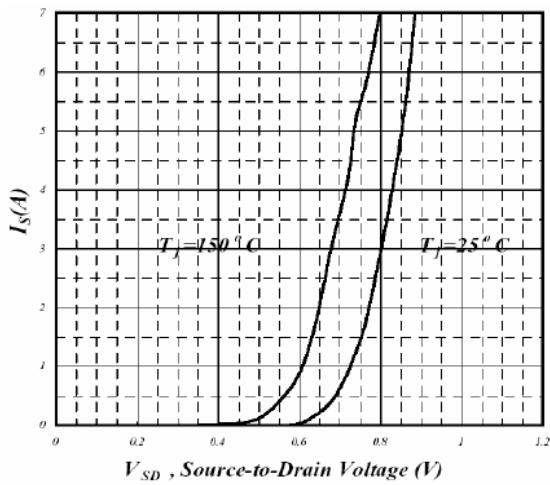

Fig 5. Forward Characteristics of Reverse Diode

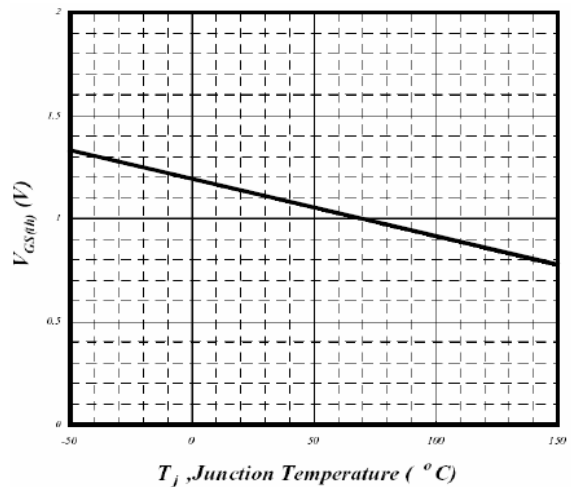

Fig 6. Gate Threshold Voltage v.s. Junction Temperature

N-channel Characteristic Curves(Cont.)

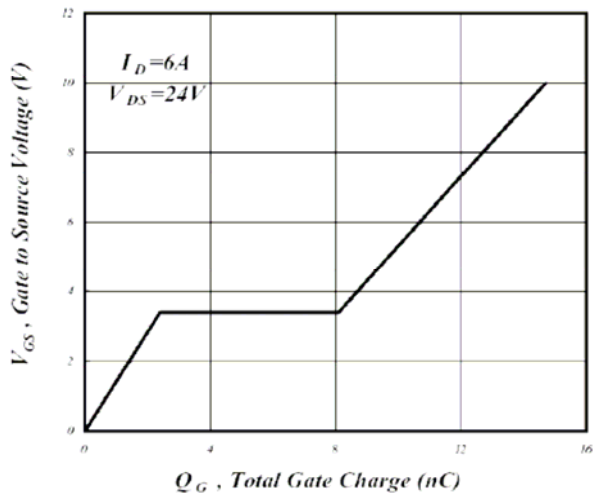

Fig 7. Gate Charge Characteristics

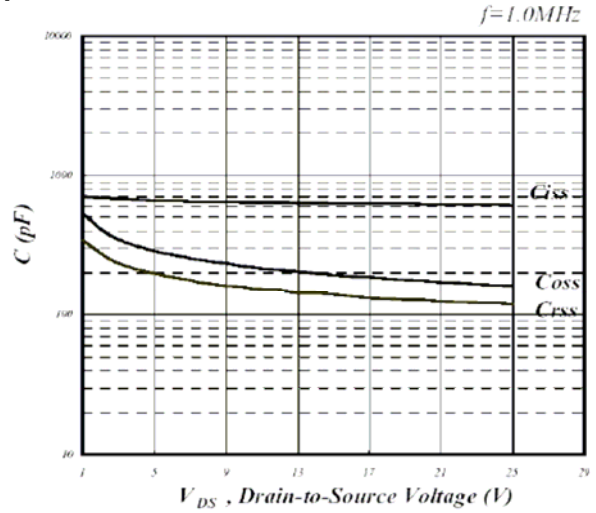

Fig 8. Typical Capacitance Characteristics

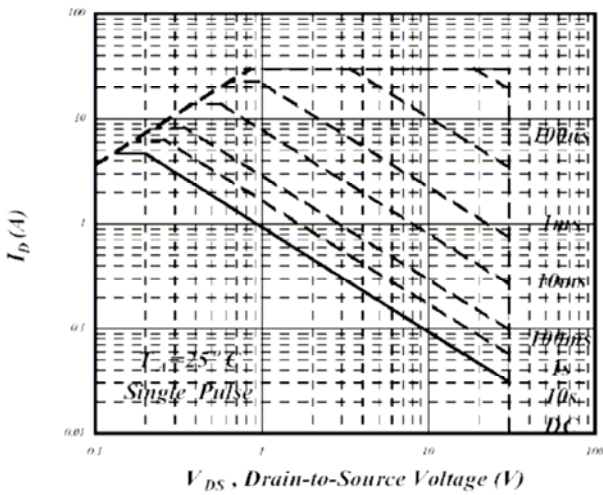

Fig 9. Maximum Safe Operating Area

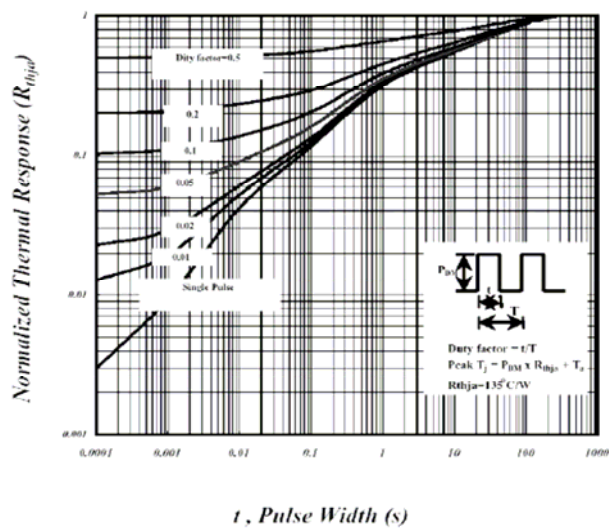

Fig 10. Effective Transient Thermal Impedance

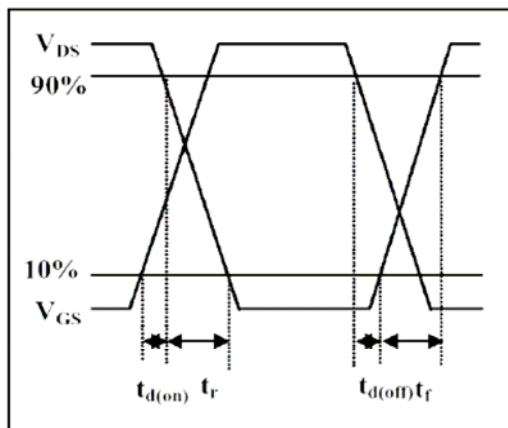

Fig 11. Switching Time Waveform

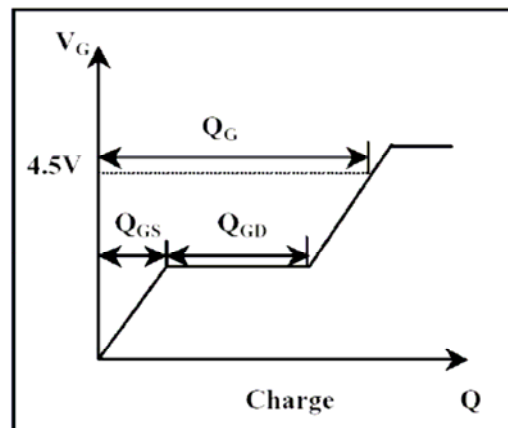

Fig 12. Gate Charge Waveform

P-channel Characteristic Curves

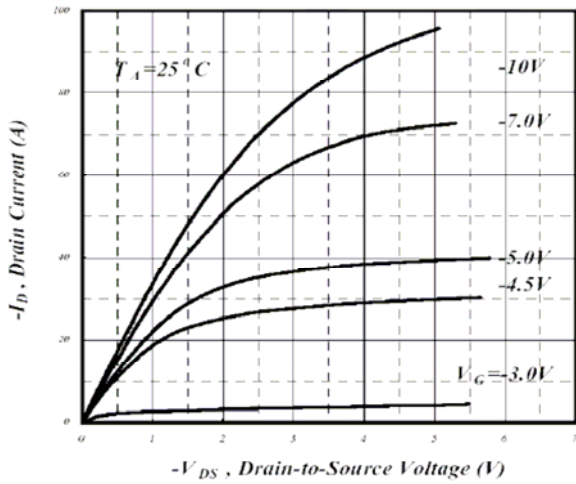

Fig 1. Typical Output Characteristics

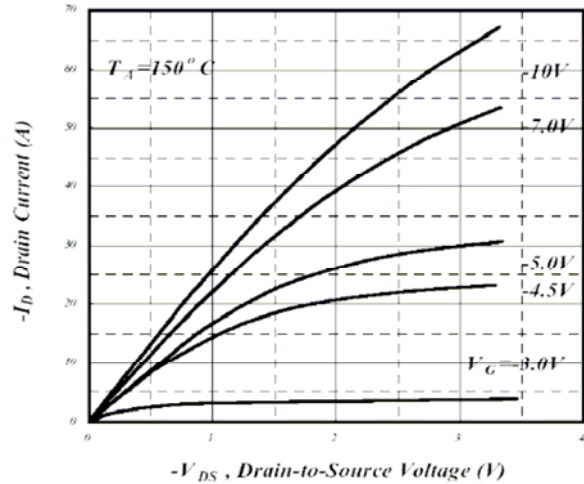

Fig 2. Typical Output Characteristics

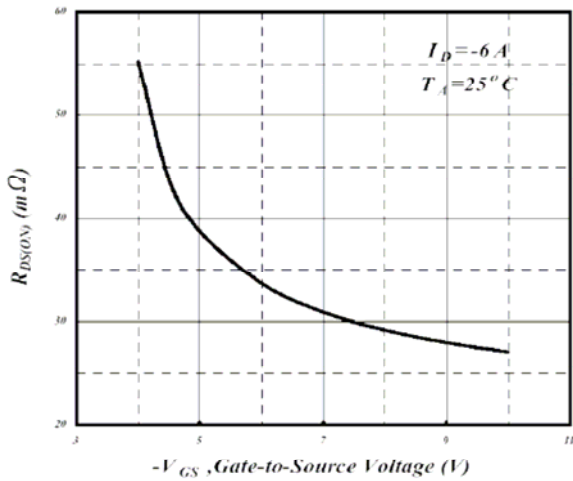

Fig 3. On-Resistance v.s. Gate Voltage

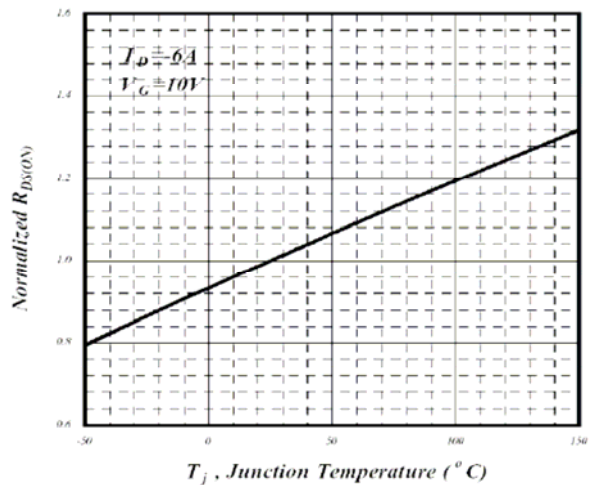

Fig 4. Normalized On-Resistance v.s. Junction Temperature

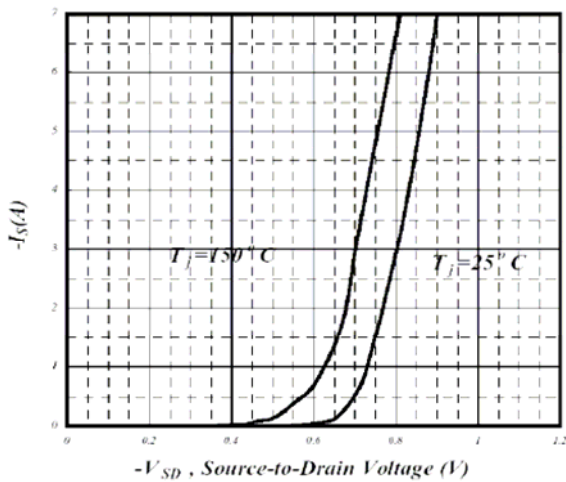

Fig 5. Forward Characteristics of Reverse Diode

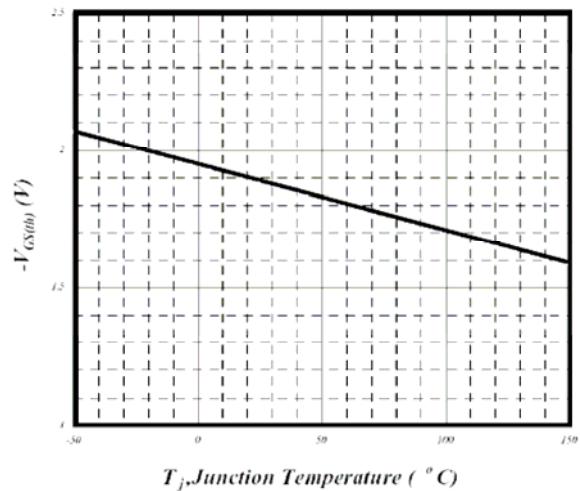

Fig 6. Gate Threshold Voltage v.s. Junction Temperature

P-channel Characteristic Curves(Cont.)

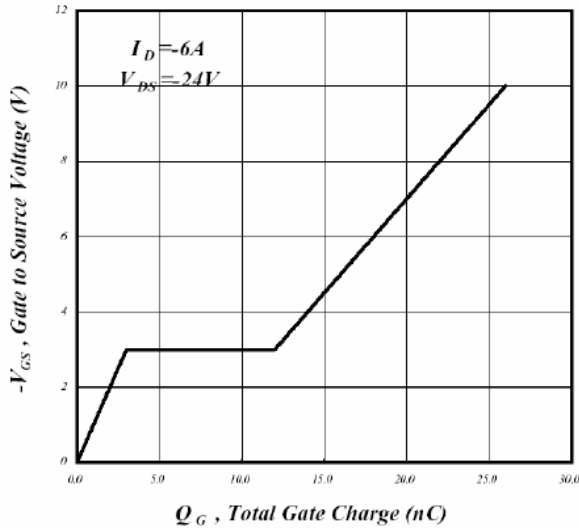

Fig 7. Gate Charge Characteristics

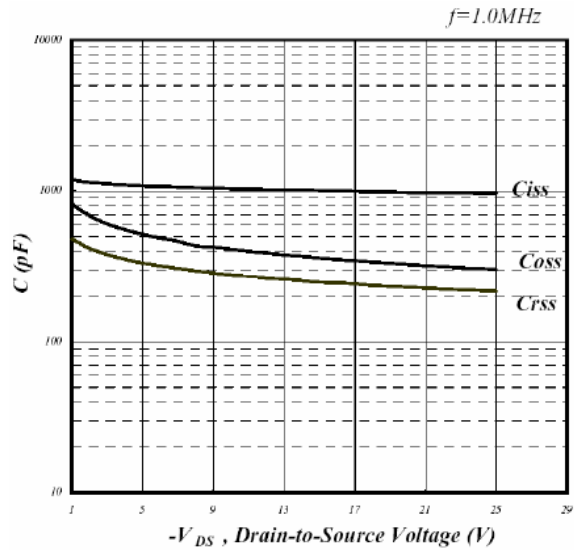

Fig 8. Typical Capacitance Characteristics

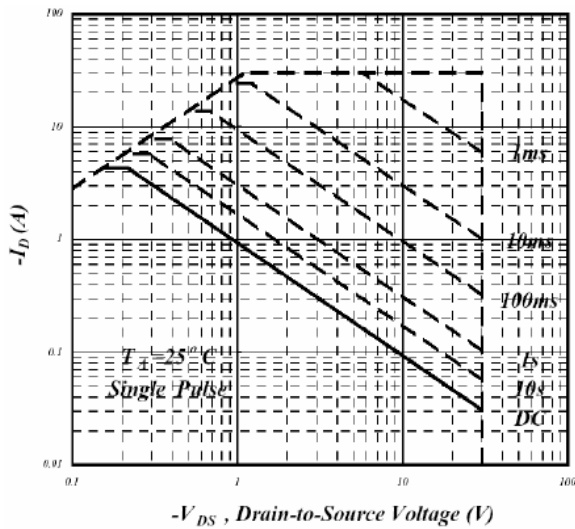

Fig 9. Maximum Safe Operating Area

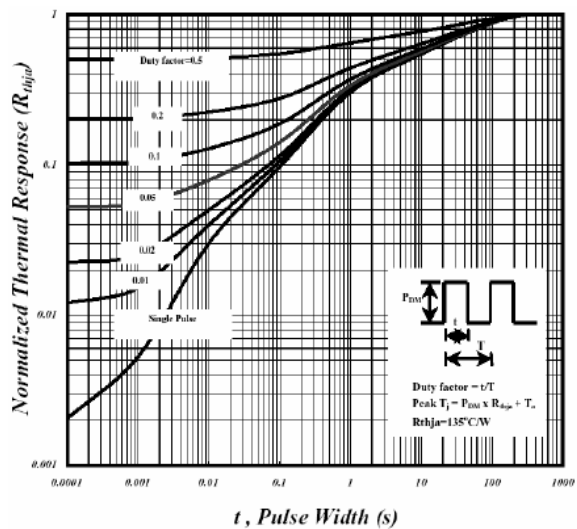

Fig 10. Effective Transient Thermal Impedance

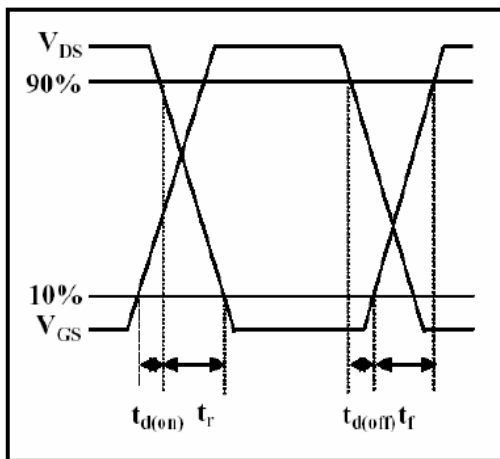

Fig 11. Switching Time Waveform

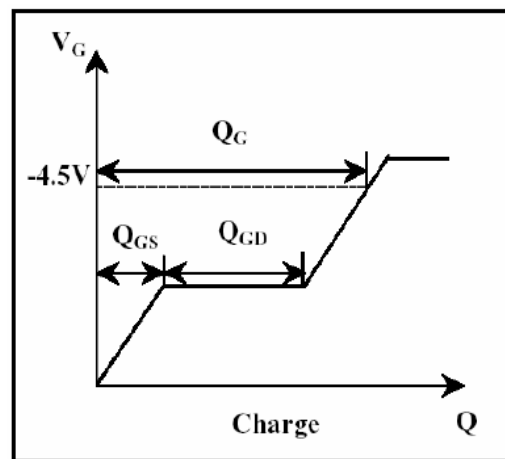
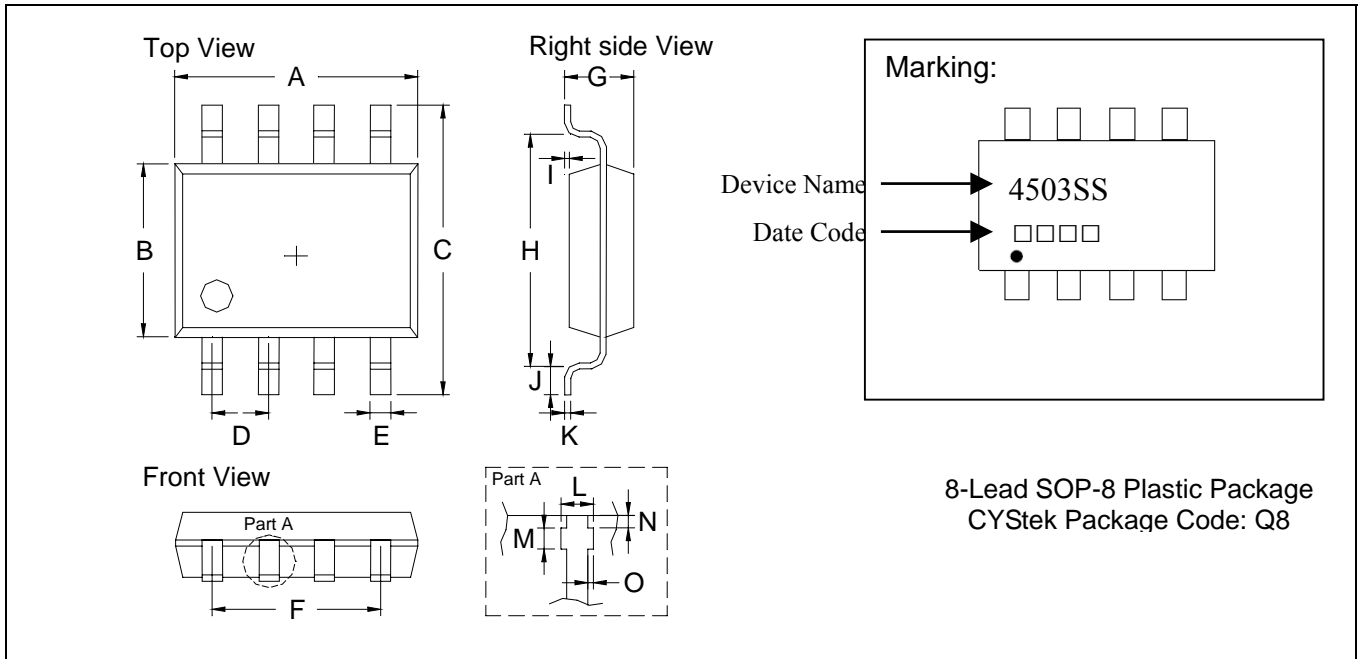

Fig 12. Gate Charge Waveform

SOP-8 Dimension



*: Typical

DIM	Inches		Millimeters		DIM	Inches		Millimeters	
	Min.	Max.	Min.	Max.		Min.	Max.	Min.	Max.
A	0.1909	0.2007	4.85	5.10	I	0.0019	0.0078	0.05	0.20
B	0.1515	0.1555	3.85	3.95	J	0.0118	0.0275	0.30	0.70
C	0.2283	0.2441	5.80	6.20	K	0.0074	0.0098	0.19	0.25
D	0.0480	0.0519	1.22	1.32	L	0.0145	0.0204	0.37	0.52
E	0.0145	0.0185	0.37	0.47	M	0.0118	0.0197	0.30	0.50
F	0.1472	0.1527	3.74	3.88	N	0.0031	0.0051	0.08	0.13
G	0.0570	0.0649	1.45	1.65	O	0.0000	0.0059	0.00	0.15
H	0.1889	0.2007	4.80	5.10					

- Notes: 1. Controlling dimension: millimeters.
 2. Maximum lead thickness includes lead finish thickness, and minimum lead thickness is the minimum thickness of base material.
 3. If there is any question with packing specification or packing method, please contact your local CYStek sales office.

Material:

- Lead: 42 Alloy; solder plating
- Mold Compound: Epoxy resin family, flammability solid burning class: UL94V-0

Important Notice:

- All rights are reserved. Reproduction in whole or in part is prohibited without the prior written approval of CYStek.
- CYStek reserves the right to make changes to its products without notice.
- CYStek **semiconductor products are not warranted to be suitable for use in Life-Support Applications, or systems.**
- CYStek assumes no liability for any consequence of customer product design, infringement of patents, or application assistance.