

# IM Series

## Signal Relays

## IM Relay

### Disclaimer

While Tyco Electronics and its affiliates referenced herein have made every reasonable effort to ensure the accuracy of the information contained in this catalog, Tyco Electronics cannot assure that this information is error free. For this reason, Tyco Electronics does not make any representation or offer any guarantee that such information is accurate, correct, reliable or current. Tyco Electronics reserves the right to make any adjustments to the information at any time. Tyco Electronics expressly disclaims any implied warranty regarding the information contained herein, including, but not limited to, the implied warranties of merchantability or fitness for a particular purpose. Tyco Electronics' only obligations are those stated in Tyco Electronics' Standard Terms and Conditions of Sale. Tyco Electronics will in no case be liable for any incidental, indirect or consequential damages arising from or in connection with, including, but not limited to, the sale, resale, use or misuse of its products. Users should rely on their own judgment to evaluate the suitability of a product for a certain purpose and test each product for its intended application.

In case of any potential ambiguities or questions, please don't hesitate to contact us for clarification.

### Index

Description	3
Selection Guide / Relay Code	4
Coil Data and Ordering Information	
- IM	5
- IM-A	10
- IM-B	12
- IM-C	14
- IM-D	16
- IM-E	18
Contact Data	20
Insulation	22
General Data	23
Coil Operating Range	24
Soldering Condition	25
Packing	26



UL 508 File No. E 111441  
UL 60950

IEC/EN60950 IEC Ref. Cert. No. 3270

## IM Relay

### IM Relay

1 and 2 pole telecom/signal relay, polarized Through Hole Types (THT), standard version with 5.08 mm, narrow with 3.2 mm between the terminal rows or Surface Mount Type (SMT)

Relay Types: non – latching with 1 coil  
latching with 1 coil

Configurations:

2 pole changeover / DPDT / 2 Form C	IM
2 pole break / DPST NC / 2 Form B	IM-D
2 pole make / DPST NO / 2 Form A	IM-E
1 pole changeover / SPDT / 1 Form C	IM-C
1 pole break / SPST NC / 1 Form B	IM-A
1 pole make / SPST NO / 1 Form A	IM-B

ROHS compliant (Directive 2002/95/EC) as per product date code 0438 / Halogen free

### Features

- Minimum board-space 60 mm<sup>2</sup>
- Slim line 10 x 6 mm, 0.39 x 0.24 inch and
- Low profile 5.65 mm, 0.222 inch
- Switching power 60 W / 62.5 VA
- Switching voltage 220 VDC / 250VAC
- Switching current 2 / 5 A
- Bifurcated contacts
- Low coil power consumption
- Latching version
  - 100 mW
- Non latching version
  - 140 mW standard
  - 100 mW high sensitive version
  - 50 mW ultra high sensitive version
- High dielectric and surge capability (1.2/50 µs and 10/700 µs) meets Telcordia GR1089, FCC Part 68 and ITU-T K20, K21 and K45 requirements
  - up to 2500 Vrms between open contacts
  - up to 3000 Vrms between coil and contacts
- Meets 1500 Vrms (high dielectric version) between open contacts as well as Australian clearance requirements
- High mechanical shock resistance up to 300G functional and 500G survival

### Typical Applications

- Telecommunication
  - Access and transmission equipment
  - Optical Network Terminals
  - Modems
- Office and business equipment
- Consumer electronics
- Measurement and Test equipment
- Industrial control
- Medical equipment
- Automotive applications

### Versions

- High Dielectric Version “C” Type
- High Current Version “D” Type
- High Contact Resistance Stability Version “P” Type

### Insulation Category

Supplementary insulation according IEC / EN 60950  
 Working voltage ≤ 300 Vrms  
 Mains supply voltage ≤ 250 Vrms  
 Repetitive peak voltage 2500 V  
 Pollution degree Internal: 1  
 External: 2  
 Flammability classification V-0  
 Maximum operating temperature 85 °C  
 Meets Australian Requirements between open contacts

## IM Relay

### Selection Guide

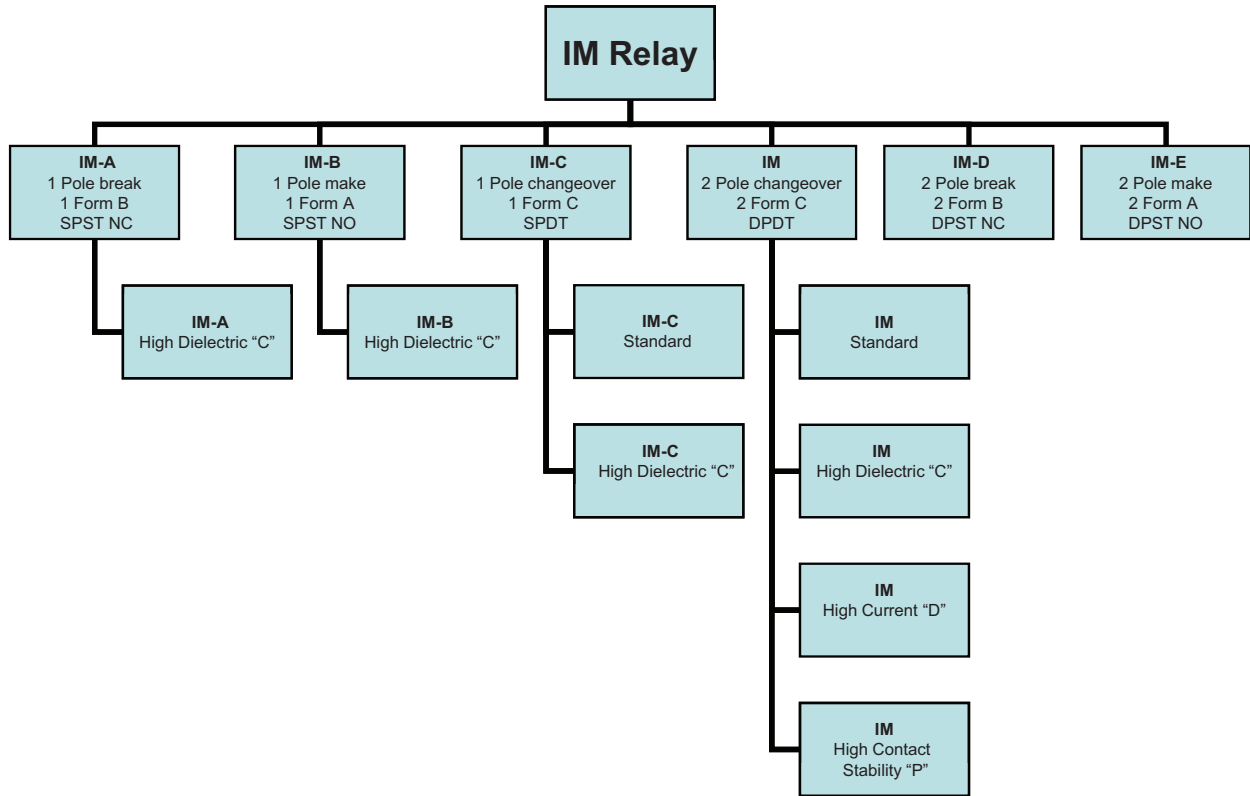

### Relay Code

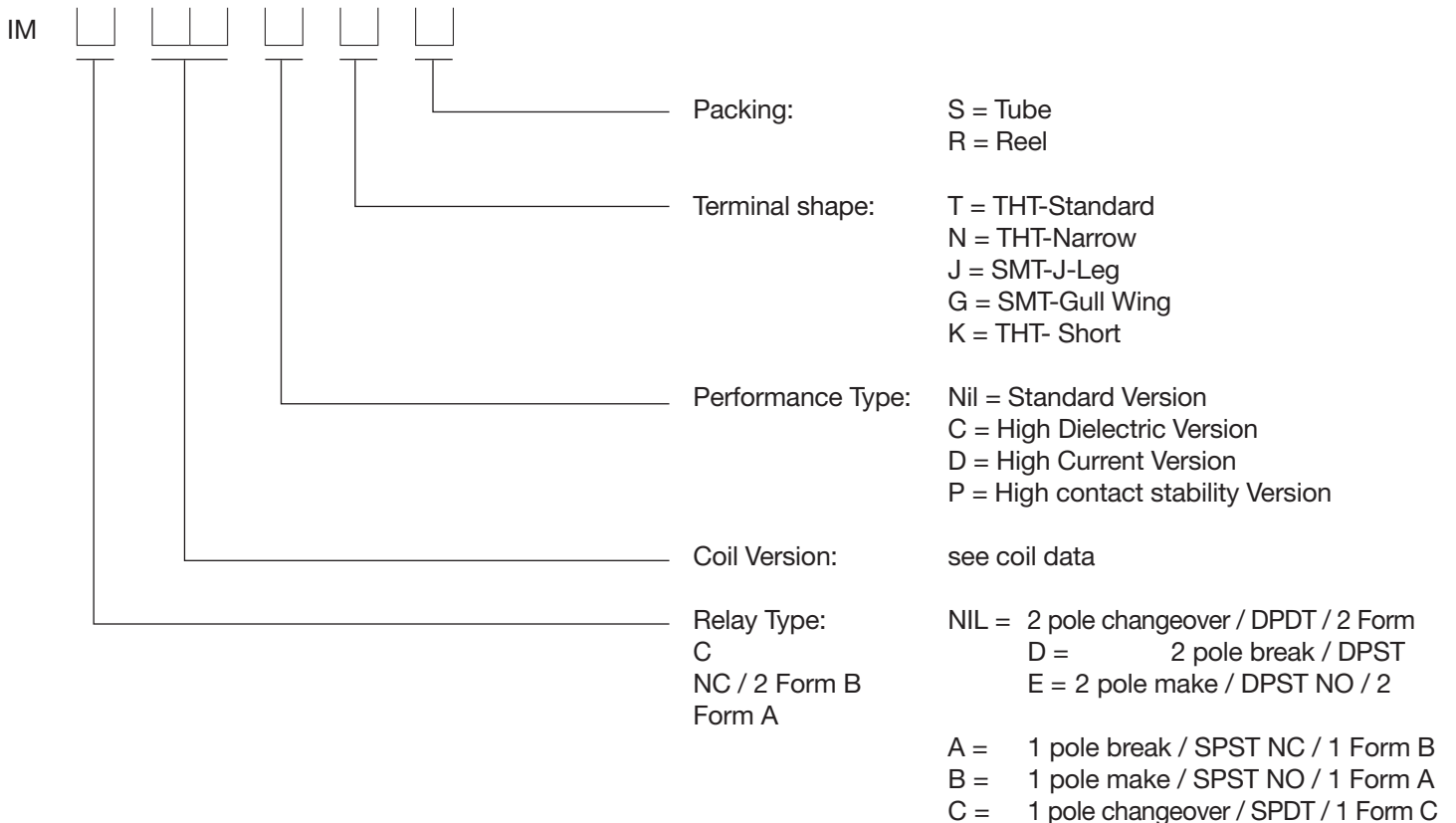

## IM Relay 2 Pole Changeover / 2 Form C / DPDT

### Dimensions Dimensions in mm

	IM THT Standard		IM THT Narrow		IM SMT Gull Wings		IM SMT J-Legs	
	mm	inch	mm	inch	mm	inch	mm	inch
L	10.00 ± 0.08	0.393 ± 0.003	10.00 ± 0.08	0.393 ± 0.003	10.00 ± 0.08	0.393 ± 0.003	10.00 ± 0.08	0.393 ± 0.003
W	6.00 ± 0.08	0.236 ± 0.003	5.70 ± 0.30	0.224 ± 0.012	6.00 ± 0.08	0.236 ± 0.003	6.00 ± 0.08	0.236 ± 0.003
H	5.65 - 0.20	0.222 - 0.008	5.80 ± 0.08	0.230 ± 0.003	5.65 - 0.20	0.222 - 0.008	5.65 - 0.02	0.222 - 0.008
T	3.2	0.125	3.2	0.125	N/A	N/A	N/A	N/A
T1	N/A	N/A	N/A	N/A	7.50 ± 0.30	0.295 ± 0.011	2.80 ± 0.20	0.110 ± 0.007
T2	5.08 ± 0.10	0.200 ± 0.004	3.20 ± 0.10	0.126 ± 0.004	5.08 ± 0.10	0.200 ± 0.004	5.08 ± 0.10	0.200 ± 0.004
D1	3.20 ± 0.15	0.126 ± 0.006	3.20 ± 0.15	0.126 ± 0.006	3.20 ± 0.15	0.126 ± 0.006	3.20 ± 0.15	0.126 ± 0.006
D2	2.20 ± 0.15	0.087 ± 0.006	2.20 ± 0.15	0.087 ± 0.006	2.20 ± 0.15	0.087 ± 0.006	2.20 ± 0.15	0.087 ± 0.006
Tw	0.40	0.015	0.4	0.015	0.4	0.015	0.4	0.015
S	0.75	0.029	0.30 ± 0.05	0.011 ± 0.002	N/A	N/A	N/A	N/A

### THT Version

#### Standard Version

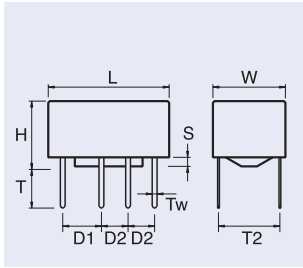

#### Narrow Version

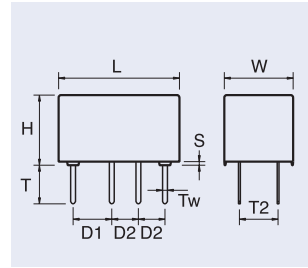

### SMT Version

#### Gull Wings

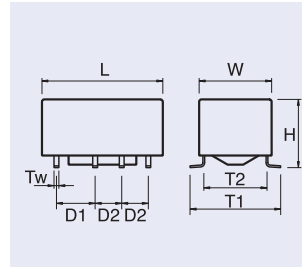

Coplanarity ≤ 0.1mm

#### J-Legs

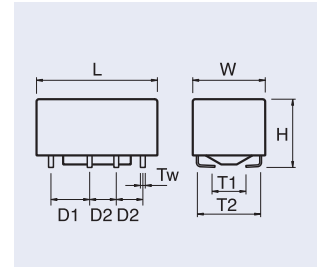

Coplanarity ≤ 0.1mm

### Mounting Hole Layout

View onto the component side of the PCB (top view)

#### Standard Version

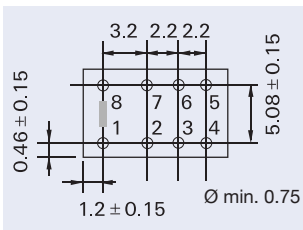

#### Narrow Version

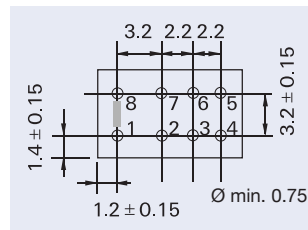

### Solder Pad Layout

View onto the component side of the PCB (top view)

#### Gull Wings

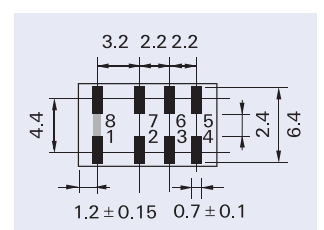
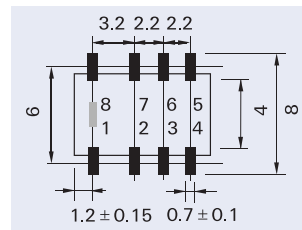

### Terminal Assignment

Relay – top view

#### Non-Latching Type

not energized condition

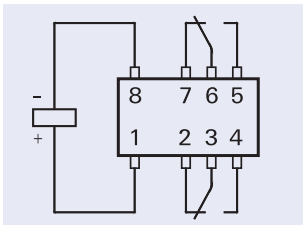

#### Latching Type, 1 Coil

reset condition

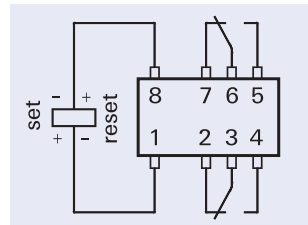

Contacts in reset position. Contact position might change during transportation and must be reset before use.

## IM Relay 2 Pole Changeover / 2 Form C / DPDT

### Coil Data (values at 23 °C)

### Ordering Information

Nominal voltage $U_{nom}$	Operate/set voltage range		Release/ reset voltage Minimum	Coil power	Coil Resistance	Relay code	Tyco Electronics part number
	Minimum voltage $U_{min}$	Maximum voltage $U_{max}$					
Vdc	Vdc	Vdc	Vdc	mW	$\Omega / \pm 10 \%$		

### Standard Version

#### THT Standard non-latching 1 coil

1.5	1.13	3.60	0.15	140	16	IM00TS	3-1462037-5
3	2.25	7.20	0.30	140	64	IM01TS	1462037-4
4.5	3.38	10.80	0.45	140	145	IM02TS	1-1462037-3
5	3.75	12.10	0.50	140	178	IM03TS	1-1462037-8
6	4.50	14.50	0.60	140	257	IM04TS	4-1462037-1
9	6.75	21.70	0.90	140	579	IM05TS	2-1462037-2
12	9.00	28.90	1.20	140	1029	IM06TS	2-1462037-7
24	18.00	48.50	2.40	200	2880	IM07TS	3-1462037-0

#### THT Narrow non-latching 1 coil

1.5	1.13	3.60	0.15	140	16	IM00NS	1-1462038-0
3	2.25	7.20	0.30	140	64	IM01NS	1-1462038-1
4.5	3.38	10.80	0.45	140	145	IM02NS	1-1462038-2
5	3.75	12.10	0.50	140	178	IM03NS	1-1462038-3
6	4.50	14.50	0.60	140	257	IM04NS	1-1462038-4
9	6.75	21.70	0.90	140	579	IM05NS	1-1462038-5
12	9.00	28.90	1.20	140	1029	IM06NS	1-1462038-6
24	18.00	48.50	2.40	200	2880	IM07NS	1-1462038-7

#### SMT J-Legs non-latching 1 coil

1.5	1.13	3.60	0.15	140	16	IM00JR	3-1462037-9
3	2.25	7.20	0.30	140	64	IM01JR	4-1462037-0
4.5	3.38	10.80	0.45	140	145	IM02JR	1-1462037-1
5	3.75	12.10	0.50	140	178	IM03JR	1-1462037-6
6	4.50	14.50	0.60	140	257	IM04JR	4-1462037-4
9	6.75	21.70	0.90	140	579	IM05JR	4-1462037-5
12	9.00	28.90	1.20	140	1029	IM06JR	4-1462037-6
24	18.00	48.50	2.40	200	2880	IM07JR	4-1462037-8

#### SMT Gull Wings non-latching 1 coil

1.5	1.13	3.60	0.15	140	16	IM00GR	3-1462037-7
2.4	1.80	6.80	0.24	140	41	IM08GR	6-1462039-3
3	2.25	7.20	0.30	140	64	IM01GR	1462037-1
4.5	3.38	10.80	0.45	140	145	IM02GR	1462037-9
5	3.75	12.10	0.50	140	178	IM03GR	1-1462037-4
6	4.50	14.50	0.60	140	257	IM04GR	4-1462037-2
9	6.75	21.70	0.90	140	579	IM05GR	3-1462037-4
12	9.00	28.90	1.20	140	1029	IM06GR	2-1462037-3
24	18.00	48.50	2.40	200	2880	IM07GR	4-1462037-7

Further coil versions are available on request.

## IM Relay 2 Pole Changeover / 2 Form C / DPDT

### Coil Data (values at 23 °C)

### Ordering Information

Nominal voltage $U_{nom}$	Operate/set voltage range		Release/ reset voltage Minimum	Coil power	Coil Resistance	Relay code	Tyco Electronics part number
	Minimum voltage $U_{min}$	Maximum voltage $U_{max}$					
Vdc	Vdc	Vdc	Vdc	mW	$\Omega / \pm 10 \%$		

### Latching Version

#### THT Standard latching 1 coil

1.5	1.13	4.30	-1.13	100	23	IM40TS	5-1462037-0
3	2.25	8.40	-2.25	100	90	IM41TS	5-1462037-3
4.5	3.38	12.90	-3.38	100	203	IM42TS	5-1462037-6
5	3.75	14.30	-3.75	100	250	IM43TS	5-1462037-8
6	4.50	17.10	-4.50	100	360	IM44TS	6-1462037-1
9	6.75	25.70	-6.75	100	810	IM45TS	3-1462037-2
12	9.00	34.30	-9.00	100	1440	IM46TS	6-1462037-6
24	18.00	48.50	-18.00	200	2880	IM47TS	6-1462037-9

#### THT Narrow latching 1 coil

1.5	1.13	4.30	-1.13	100	23	IM40NS	1-1462038-8
3	2.25	8.40	-2.25	100	90	IM41NS	1-1462038-9
4.5	3.38	12.90	-3.38	100	203	IM42NS	2-1462038-0
5	3.75	14.30	-3.75	100	250	IM43NS	2-1462038-1
6	4.50	17.10	-4.50	100	360	IM44NS	2-1462038-2
9	6.75	25.70	-6.75	100	810	IM45NS	2-1462038-3
12	9.00	34.30	-9.00	100	1440	IM46NS	2-1462038-4
24	18.00	48.50	-18.00	200	2880	IM47NS	2-1462038-5

#### SMT J-Legs latching 1 coil

1.5	1.13	4.30	-1.13	100	23	IM40JR	5-1462037-2
3	2.25	8.40	-2.25	100	90	IM41JR	5-1462037-5
4.5	3.38	12.90	-3.38	100	203	IM42JR	5-1462037-7
5	3.75	14.30	-3.75	100	250	IM43JR	6-1462037-0
6	4.50	17.10	-4.50	100	360	IM44JR	6-1462037-3
9	6.75	25.70	-6.75	100	810	IM45JR	6-1462037-5
12	9.00	34.30	-9.00	100	1440	IM46JR	6-1462037-8
24	18.00	48.50	-18.00	200	2880	IM47JR	7-1462037-1

#### SMT Gull Wings latching 1 coil

1.5	1.13	4.30	-1.13	100	23	IM40GR	5-1462037-1
3	2.25	8.40	-2.25	100	90	IM41GR	5-1462037-4
4.5	3.38	12.90	-3.38	100	203	IM42GR	3-1462037-1
5	3.75	14.30	-3.75	100	250	IM43GR	5-1462037-9
6	4.50	17.10	-4.50	100	360	IM44GR	6-1462037-2
9	6.75	25.70	-6.75	100	810	IM45GR	6-1462037-4
12	9.00	34.30	-9.00	100	1440	IM46GR	6-1462037-7
24	18.00	48.50	-18.00	200	2880	IM47GR	7-1462037-0

Further coil versions are available on request.

## IM Relay 2 Pole Changeover / 2 Form C / DPDT

### Coil Data (values at 23 °C)

### Ordering Information

Nominal voltage $U_{nom}$	Operate/set voltage range		Release/ reset voltage Minimum	Coil power	Coil Resistance	Relay code	Tyco Electronics part number
	Minimum voltage $U_{min}$	Maximum voltage $U_{max}$					
Vdc	Vdc	Vdc	Vdc	mW	$\Omega / \pm 10 \%$		

### High Sensitive Version

#### SMT Gull Wings non-latching 1 coil

3	2.40	8.70	0.30	100	91	IM11GR	9-1462038-5
4.5	3.60	13.10	0.45	100	194	IM12GR	1462039-3
5	4.00	14.60	0.50	100	238	IM13GR	1462039-4
12	9.60	35.00	1.20	110	1315	IM16GR	1462039-5
24	19.20	57.80	2.40	140	4120	IM17GR	1462039-6

### High Dielectric Version

#### SMT Gull Wings non-latching 1 coil

3	2.25	7.20	0.30	140	64	IM01CGR	1462038-4
4.5	3.38	10.80	0.45	140	145	IM02CGR	1462038-1
5	3.75	12.10	0.50	140	178	IM03CGR	1462038-2
9	6.75	21.70	0.90	140	579	IM05CGR	1462038-3
12	9.00	28.90	1.20	140	1029	IM06CGR	9-1462037-9
24	18.00	48.50	2.40	200	2880	IM07CGR	1462039-2

#### SMT Gull Wings latching 1 coil

3	2.25	8.40	-2.25	100	90	IM41CGR	4-1462039-2
4.5	3.38	12.90	-3.38	100	203	IM42CGR	4-1462039-1
5	3.75	14.30	-3.75	100	250	IM43CGR	9-1462038-7

### High Current/Low Contact Resistance Version

#### SMT Gull Wings non-latching 1 coil

4.5	3.38	10.80	0.45	140	145	IM02DGR	9-1462038-8
5	3.75	12.10	0.50	140	178	IM03DGR	9-1462038-9
9	6.75	21.70	0.90	140	579	IM05DGR	1-1462039-7
12	9.00	28.90	1.20	140	1029	IM06DGR	1-1462039-8

#### THT non-latching 1 coil

12	9.0	28.90	1.20	140	1029	IM06DTS	3-1462039-8
----	-----	-------	------	-----	------	---------	-------------

#### SMT Gull Wings latching 1 coil

2.4	1.80	6.80	-1.80	100	58	IM48DGR	1462039-9
3.0	2.25	8.40	-2.25	100	90	IM41DGR	6-1462039-8
4.5	3.38	12.90	-3.38	100	203	IM42DGR	1-1462039-9

Further coil versions are available on request.



## IM Relay 2 Pole Changeover / 2 Form C / DPDT

### Coil Data (values at 23 °C)

### Ordering Information

Nominal voltage $U_{nom}$	Operate/set voltage range		Release/ reset voltage Minimum	Coil power	Coil Resistance	Relay code	Tyco Electronics part number
	Minimum voltage $U_{min}$	Maximum voltage $U_{max}$					
Vdc	Vdc	Vdc	Vdc	mW	$\Omega / \pm 10 \%$		

### Ultra High Sensitive Version

#### SMT Gull Wings non-latching 1 coil

3	2.55	10.80	0.30	50	180	IM21GR	2-1462039-6
4.5	3.83	16.20	0.45	50	405	IM22GR	2-1462039-7
5	4.25	18.00	0.50	50	500	IM23GR	2-1462039-9
12	10.20	43.20	1.20	50	2880	IM26GR	3-1462039-1

#### THT non-latching 1 coil

3	2.55	10.80	0.30	50	180	IM21TS	1-1462039-5
4.5	3.83	16.20	0.45	50	405	IM22TS	2-1462039-8
5	4.25	18.00	0.50	50	500	IM23TS	3-1462039-0
12	10.20	43.20	1.20	50	2880	IM26TS	3-1462039-2

### High Contact Stability Version

#### SMT Gull Wings non-latching 1 coil

4.5	3.83	10.80	0.45	140	145	IM02PGR	5-1462039-4
5	3.75	12.10	0.50	140	178	IM03PGR	5-1462039-5
12	9.00	28.90	1.20	140	1029	IM06PGR	5-1462039-6

#### SMT Gull Wings latching 1 coil

4.5	3.38	12.90	-3.38	100	203	IM42PGR	5-1462039-7
-----	------	-------	-------	-----	-----	---------	-------------

#### THT Narrow non-latching 1 coil

4.5	3.83	10.80	0.45	140	145	IM02PNS	5-1462039-8
5	3.75	12.10	0.50	140	178	IM03PNS	5-1462039-9
12	9.00	28.90	1.20	140	1029	IM06PNS	6-1462039-0

#### THT Narrow latching 1 coil

12	9.00	34.30	-9.00	100	1440	IM46PNS	6-1462039-1
----	------	-------	-------	-----	------	---------	-------------

Further coil versions are available on request.

## IM-A Relay 1 Pole Break / 1 Form B / SPST NC

### Dimensions IM-A

Dimensions in mm

#### THT Version

##### Standard Version

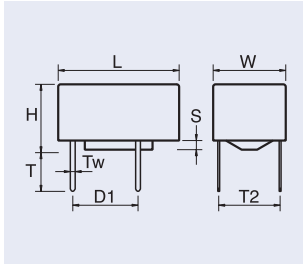

	IM THT Standard		IM SMT Gull Wings	
	mm	inch	mm	inch
L	10.00 ± 0.08	0.393 ± 0.003	10.00 ± 0.08	0.393 ± 0.003
W	6.00 ± 0.08	0.236 ± 0.003	6.00 ± 0.08	0.236 ± 0.003
H	5.65 - 0.20	0.222 - 0.008	5.65 - 0.20	0.222 - 0.008
T	3.2	0.125	N/A	N/A
T1	N/A	N/A	7.50 ± 0.30	0.295 ± 0.011
T2	5.08 ± 0.10	0.200 ± 0.004	5.08 ± 0.10	0.200 ± 0.004
D1	3.20 ± 0.15	0.126 ± 0.006	3.20 ± 0.15	0.126 ± 0.006
D2	2.20 ± 0.15	0.087 ± 0.006	2.20 ± 0.15	0.087 ± 0.006
Tw	0.40	0.015	0.4	0.015
S	0.75	0.029	N/A	N/A

#### SMT Version

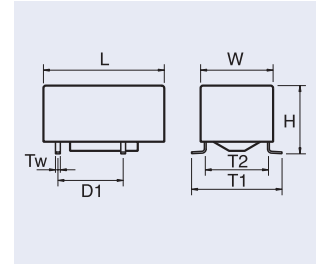

Coplanarity ≤ 0.1mm

#### Mounting Hole Layout

View onto the component side of the PCB (top view)

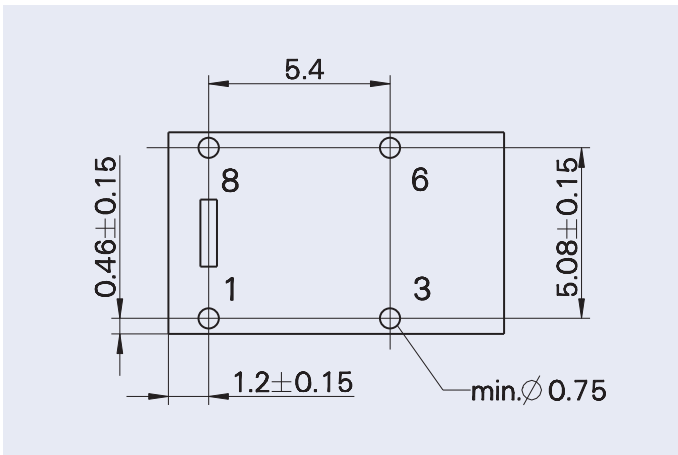

#### Solder Pad Layout

View onto the component side of the PCB (top view)

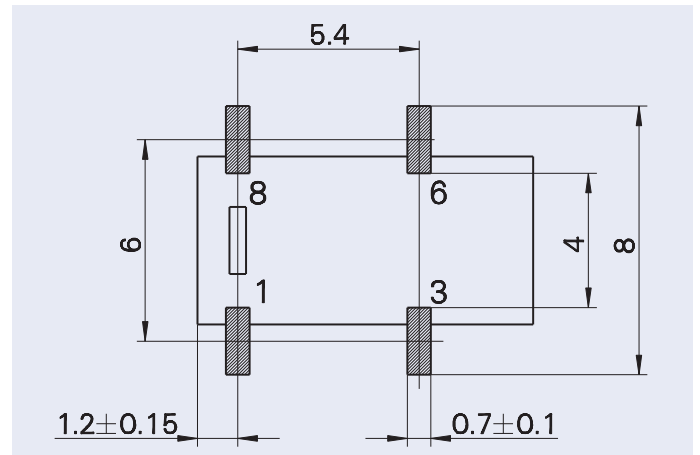

#### Terminal Assignment

Relay – top view

##### Non-Latching Type

not energized condition

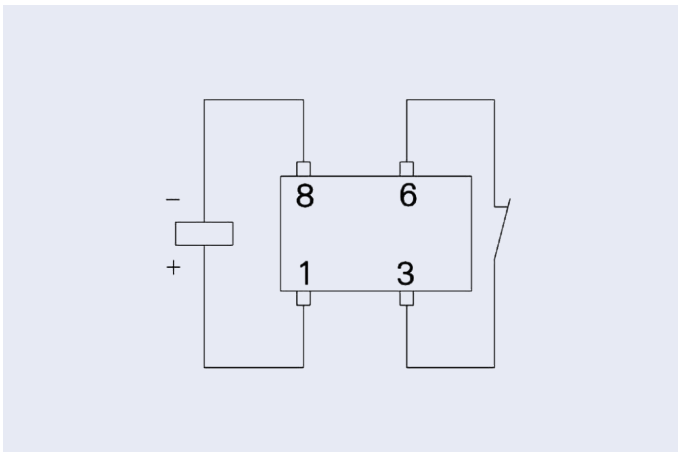

##### Latching Type, 1 Coil

reset condition

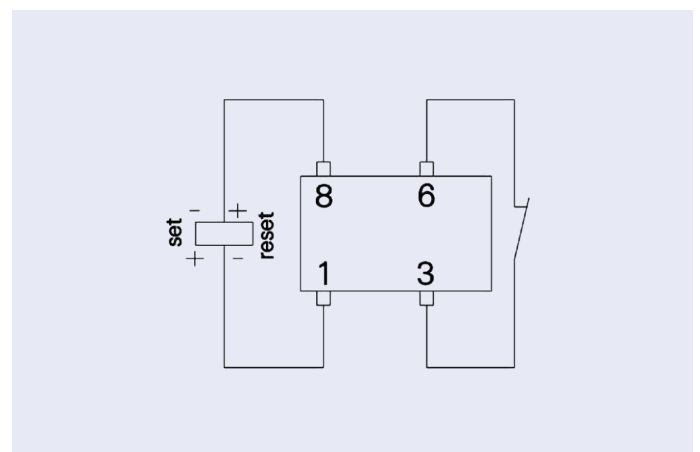

## IM-A Relay 1 Pole Break / 1 Form B / SPST NC

### Coil Data (values at 23 °C)

### Ordering Information

Nominal voltage $U_{nom}$	Operate/set voltage range		Release/ reset voltage Minimum	Coil power	Coil Resistance	Relay code	Tyco Electronics part number
	Minimum voltage $U_{min}$	Maximum voltage $U_{max}$					
Vdc	Vdc	Vdc	Vdc	mW	$\Omega / \pm 10 \%$		

### IM-A

#### SMT Gull Wings non-latching 1 coil

3	2.25	7.20	0.30	140	64	IMA01CGR	1462040-1
4.5	3.38	10.80	0.45	140	145	IMA02CGR	1462040-2
5	3.75	12.10	0.50	140	178	IMA03CGR	1462040-3
12	9.00	28.90	1.20	140	1029	IMA06CGR	1462040-4

#### THT non-latching 1 coil

3	2.25	7.20	0.30	140	64	IMA01CTS	1462040-5
4.5	3.38	10.80	0.45	140	145	IMA02CTS	1462040-6
5	3.75	12.10	0.50	140	178	IMA03CTS	1462040-7
12	9.00	28.90	1.20	140	1029	IMA06CTS	1462040-8

Further coil versions are available on request.

**IM-B Relay 1 Pole Make / 1 Form A / SPST NO**

**Dimensions IM-B** Dimensions in mm

**THT Version**  
**Standard Version**

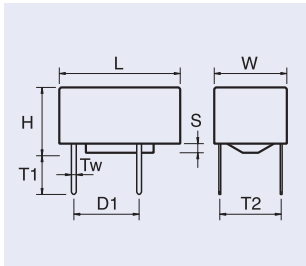

	IM THT Standard		IM SMT Gull Wings	
	mm	inch	mm	inch
L	10.00 ± 0.08	0.393 ± 0.003	10.00 ± 0.08	0.393 ± 0.003
W	6.00 ± 0.08	0.236 ± 0.003	6.00 ± 0.08	0.236 ± 0.003
H	5.65 - 0.20	0.222 - 0.008	5.65 - 0.20	0.222 - 0.008
T	3.2	0.125	N/A	N/A
T1	N/A	N/A	7.50 ± 0.30	0.295 ± 0.011
T2	5.08 ± 0.10	0.200 ± 0.004	5.08 ± 0.10	0.200 ± 0.004
D1	3.20 ± 0.15	0.126 ± 0.006	3.20 ± 0.15	0.126 ± 0.006
D2	2.20 ± 0.15	0.087 ± 0.006	2.20 ± 0.15	0.087 ± 0.006
Tw	0.40	0.015	0.4	0.015
S	0.75	0.029	N/A	N/A

**SMT Version**  
**Gull Wings**

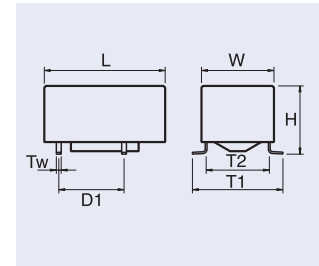

Coplanarity ≤ 0.1mm

**Mounting Hole Layout**

View onto the component side of the PCB (top view)

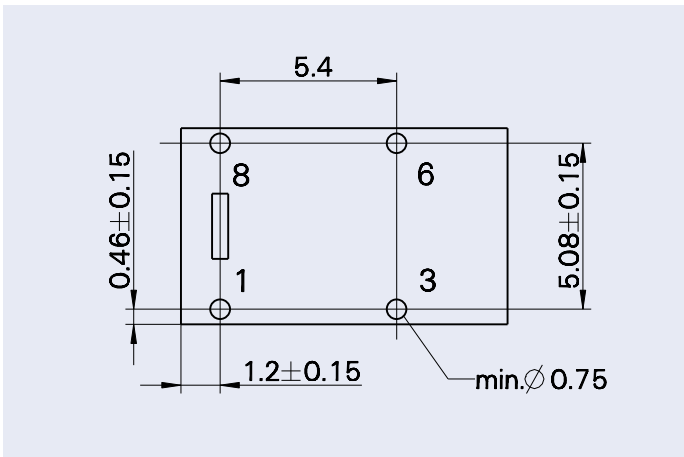

**Solder Pad Layout**

View onto the component side of the PCB (top view)

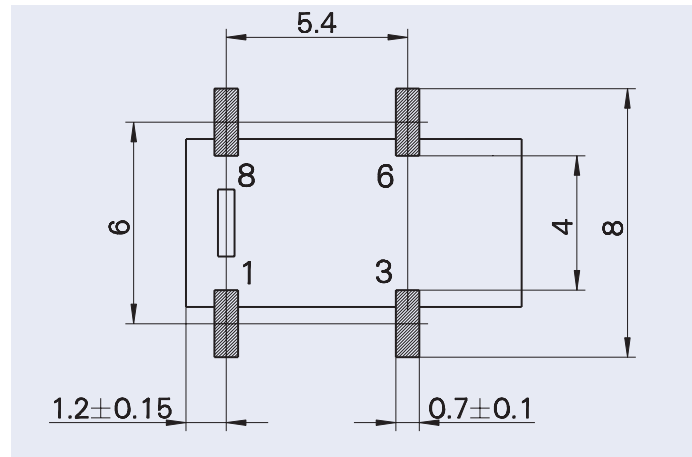

**Terminal Assignment**

Relay – top view

**Non-Latching Type**

not energized condition

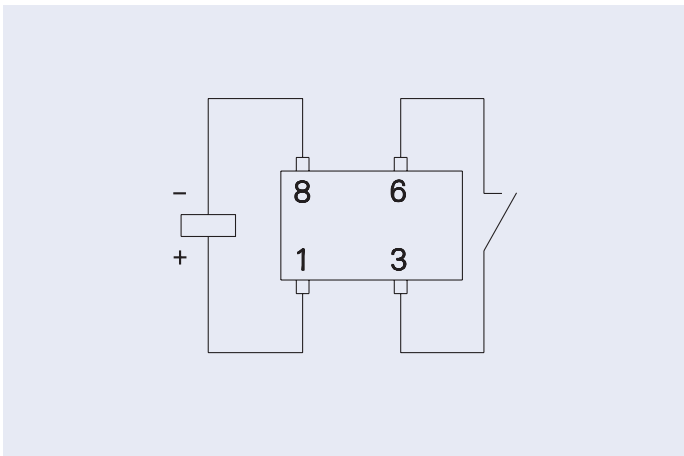

**Latching Type, 1 Coil**

reset condition

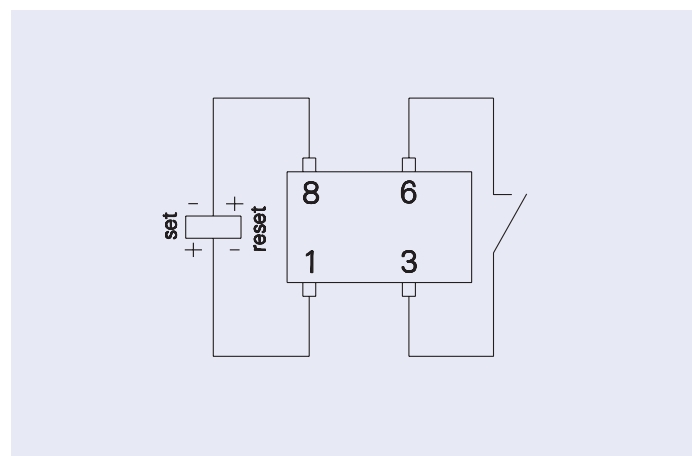

## IM-B Relay 1 Pole Make / 1 Form A / SPST NO

### Coil Data (values at 23 °C)

### Ordering Information

Nominal voltage $U_{nom}$	Operate/set voltage range		Release/ reset voltage Minimum	Coil power	Coil Resistance	Relay code	Tyco Electronics part number
	Minimum voltage $U_{min}$	Maximum voltage $U_{max}$					
Vdc	Vdc	Vdc	Vdc	mW	$\Omega / \pm 10 \%$		

### IM-B

#### SMT Gull Wings non-latching 1 coil

3	2.25	7.20	0.30	140	64	IMB01CGR	1462041-1
4.5	3.38	10.80	0.45	140	145	IMB02CGR	1462041-2
5	3.75	12.10	0.50	140	178	IMB03CGR	1462041-7
6	4.50	14.50	0.60	140	257	IMB04CGR	1462041-9
12	9.00	28.90	1.20	140	1029	IMB06CGR	1462041-3
24	18.00	48.50	2.40	200	2880	IMB07CGR	1-1462041-3

#### THT non-latching 1 coil

3	2.25	7.20	0.30	140	64	IMB01CTS	1462041-4
4.5	3.38	10.80	0.45	140	145	IMB02CTS	1462041-5
5	3.75	12.10	0.50	140	178	IMB03CTS	1462041-8
12	9.00	28.90	1.20	140	1029	IMB06CTS	1462041-6
24	18.00	48.50	2.40	200	2880	IMB07CTS	1-1462041-4

Further coil versions are available on request.

**IM-C Relay 1 Pole Changeover / 1 Form C / SPDT**

**Dimensions IM-C** Dimensions in mm

**THT Version**  
**Standard Version**

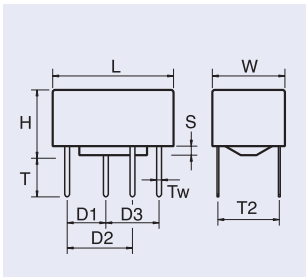

	IM THT Standard		IM SMT Gull Wings	
	mm	inch	mm	inch
L	10.00 ± 0.08	0.393 ± 0.003	10.00 ± 0.08	0.393 ± 0.003
W	6.00 ± 0.08	0.236 ± 0.003	6.00 ± 0.08	0.236 ± 0.003
H	5.65 - 0.20	0.222 - 0.008	5.65 - 0.20	0.222 - 0.008
T	3.2	0.125	N/A	N/A
T1	N/A	N/A	7.50 ± 0.30	0.295 ± 0.011
T2	5.08 ± 0.10	0.200 ± 0.004	5.08 ± 0.10	0.200 ± 0.004
D1	3.20 ± 0.15	0.126 ± 0.006	3.20 ± 0.15	0.126 ± 0.006
D2	2.20 ± 0.15	0.087 ± 0.006	2.20 ± 0.15	0.087 ± 0.006
Tw	0.40	0.015	0.4	0.015
S	0.75	0.029	N/A	N/A

**SMT Version**  
**Gull Wings**

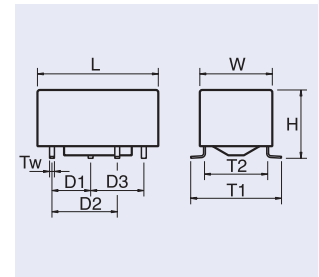

Coplanarity ≤ 0.1mm

**Mounting Hole Layout**

View onto the component side of the PCB (top view)

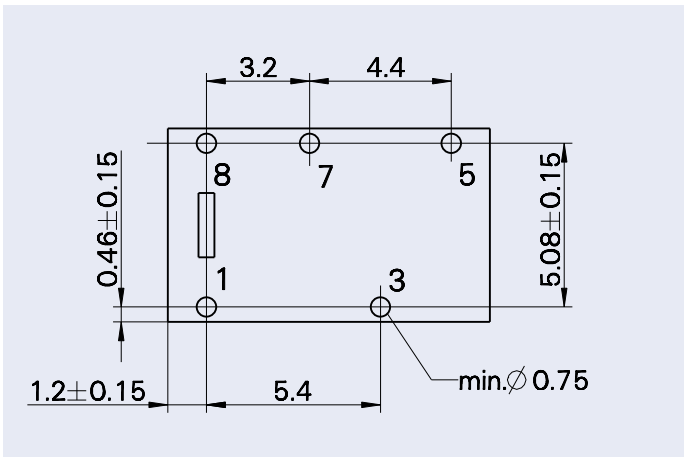

**Solder Pad Layout**

View onto the component side of the PCB (top view)

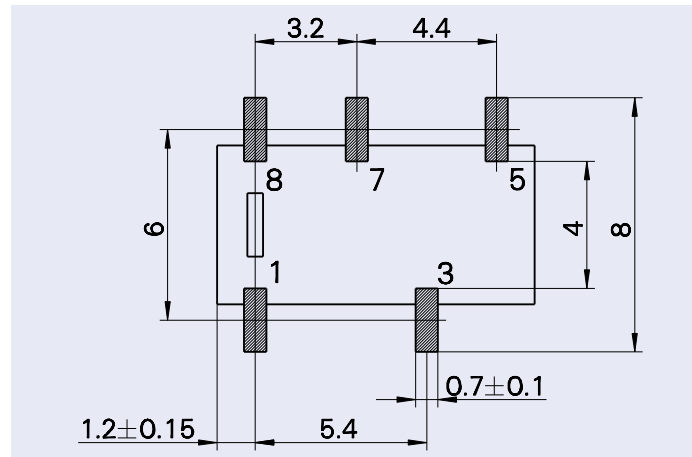

**Terminal Assignment**

Relay – top view

**Non-Latching Type**

not energized condition

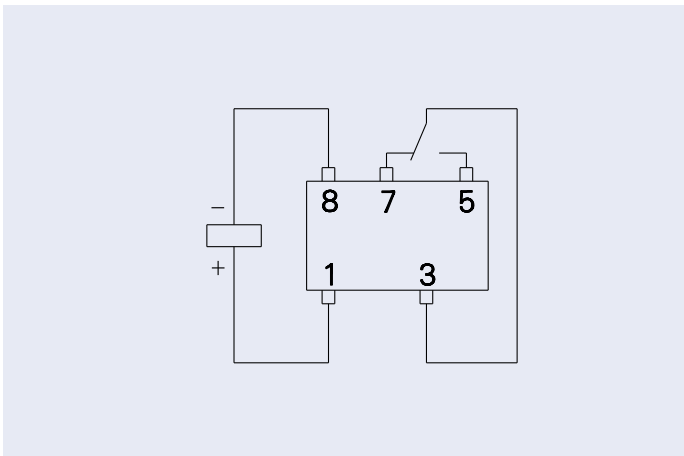

**Latching Type, 1 Coil**

reset condition

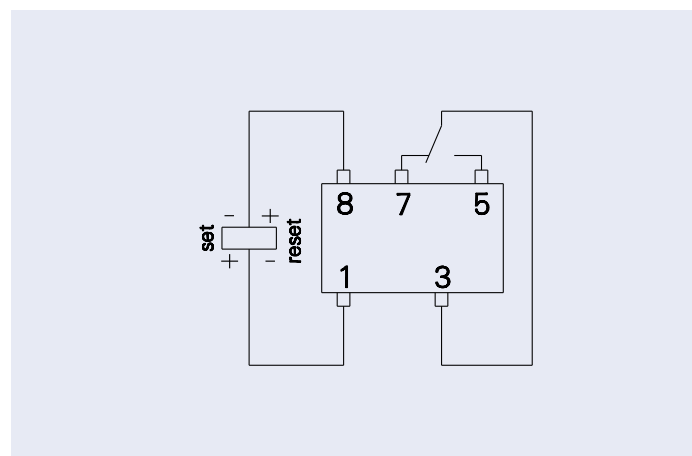

## IM-C Relay 1 Pole Changeover / 1 Form C / SPDT

### Coil Data (values at 23 °C)

### Ordering Information

Nominal voltage $U_{nom}$	Operate/set voltage range		Release/ reset voltage Minimum	Coil power	Coil Resistance	Relay code	Tyco Electronics part number
	Minimum voltage $U_{min}$	Maximum voltage $U_{max}$					
Vdc	Vdc	Vdc	Vdc	mW	$\Omega / \pm 10 \%$		

### IM-C

#### SMT Gull Wings non-latching 1 coil

3	2.25	7.20	0.30	140	64	IMC01GR	1462042-1
4.5	3.38	10.80	0.45	140	145	IMC02GR	1462042-2
5	3.75	12.10	0.50	140	178	IMC03GR	1462042-8
12	9.00	28.90	1.20	140	1029	IMC06GR	1462042-3
24	18.00	48.50	2.40	200	2880	IMC07GR	1-1462042-1

#### THT non-latching 1 coil

3	2.25	7.20	0.30	140	64	IMC01TS	1462042-4
4.5	3.38	10.80	0.45	140	145	IMC02TS	1462042-5
5	3.75	12.10	0.50	140	178	IMC03TS	1462042-7
12	9.00	28.90	1.20	140	1029	IMC06TS	1462042-6
24	18.00	48.50	2.40	200	2880	IMC07TS	1-1462042-2

### IM-C High Dielectric

#### SMT Gull Wings non-latching 1 coil

4.5	3.38	10.80	0.45	140	145	IMC02CGR	1-1462042-0
12	9.00	28.90	1.20	140	1029	IMC06CGR	1462042-9

#### THT non-latching 1 coil

12	9.00	28.90	1.20	140	1029	IMC06CTS	1-1462042-4
----	------	-------	------	-----	------	----------	-------------

#### THT latching 1 coil

3	2.25	8.40	-2.25	100	90	IMC41CTS	1-1462042-3
---	------	------	-------	-----	----	----------	-------------

Further coil versions are available on request.

**IM-D Relay 2 Pole Break / 2 Form B / DPST NC**

**Dimensions IM-D** Dimensions in mm

**THT Version**  
**Standard Version**

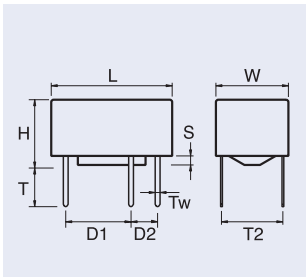

	IM THT Standard		IM SMT Gull Wings	
	mm	inch	mm	inch
L	10.00 ± 0.08	0.393 ± 0.003	10.00 ± 0.08	0.393 ± 0.003
W	6.00 ± 0.08	0.236 ± 0.003	6.00 ± 0.08	0.236 ± 0.003
H	5.65 - 0.20	0.222 - 0.008	5.65 - 0.20	0.222 - 0.008
T	3.2	0.125	N/A	N/A
T1	N/A	N/A	7.50 ± 0.30	0.295 ± 0.011
T2	5.08 ± 0.10	0.200 ± 0.004	5.08 ± 0.10	0.200 ± 0.004
D1	3.20 ± 0.15	0.126 ± 0.006	3.20 ± 0.15	0.126 ± 0.006
D2	2.20 ± 0.15	0.087 ± 0.006	2.20 ± 0.15	0.087 ± 0.006
Tw	0.40	0.015	0.4	0.015
S	0.75	0.029	N/A	N/A

**SMT Version**  
**Gull Wings**

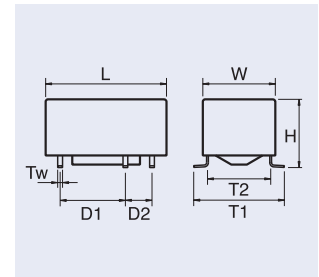

Coplanarity ≤ 0.1mm

**Mounting Hole Layout**

View onto the component side of the PCB (top view)

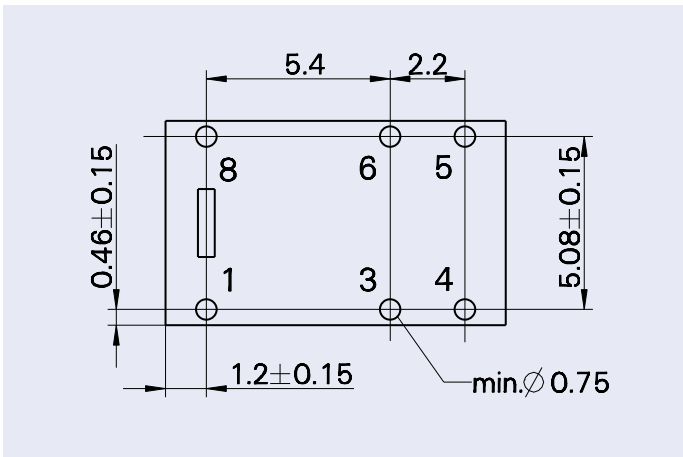

**Solder Pad Layout**

View onto the component side of the PCB (top view)

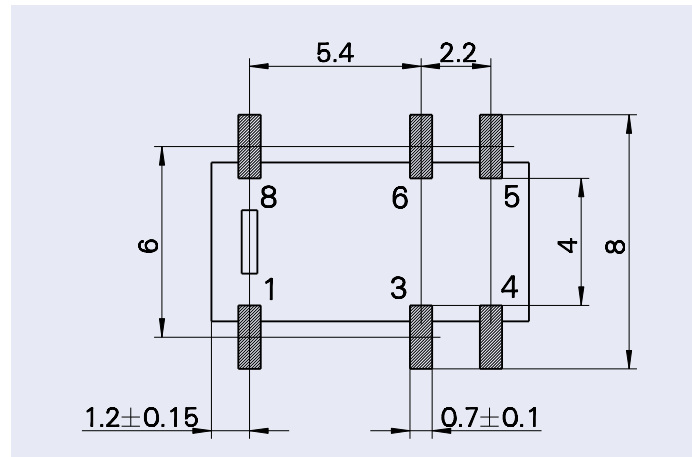

**Terminal Assignment**

Relay – top view

**Non-Latching Type**

not energized condition

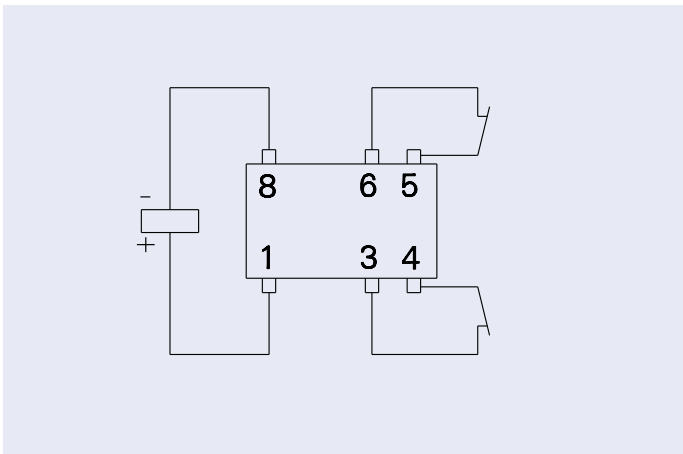

**Latching Type, 1 Coil**

reset condition

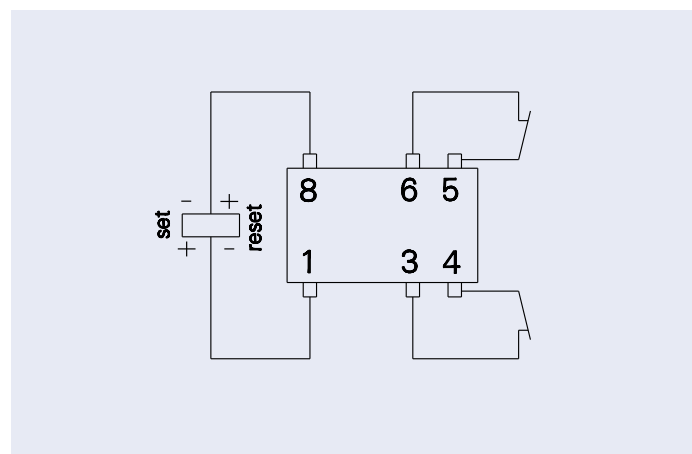



## IM-D Relay 2 Pole break / 2 Form B / DPST NC

### Coil Data (values at 23 °C)

### Ordering Information

Nominal voltage $U_{nom}$	Operate/set voltage range		Release/ reset voltage Minimum	Coil power	Coil Resistance	Relay code	Tyco Electronics part number
	Minimum voltage $U_{min}$	Maximum voltage $U_{max}$					
Vdc	Vdc	Vdc	Vdc	mW	$\Omega / \pm 10 \%$		

### IM-D

#### SMT Gull Wings non-latching 1 coil

3	2.25	7.20	0.30	140	64	IMD01GR	1462044-1
4.5	3.38	10.80	0.45	140	145	IMD02GR	1462044-2
5	3.75	12.10	0.50	140	178	IMD03GR	1462044-3
12	9.00	28.90	1.20	140	1029	IMD06GR	1462044-4

#### THT non-latching 1 coil

3	2.25	7.20	0.30	140	64	IMD01TS	1462044-5
4.5	3.38	10.80	0.45	140	145	IMD02TS	1462044-6
5	3.75	12.10	0.50	140	178	IMD03TS	1462044-7
12	9.00	28.90	1.20	140	1029	IMD06TS	1462044-8

Further coil versions are available on request.

**IM-E Relay 2 Pole Make / 2 Form A / DPST NO**

**Dimensions IM-E** Dimensions in mm

**THT Version**  
**Standard Version**

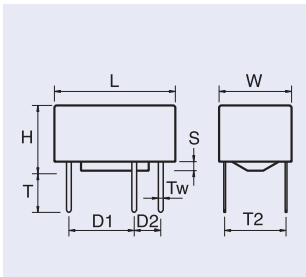

	IM THT Standard		IM SMT Gull Wings	
	mm	inch	mm	inch
L	10.00 ± 0.08	0.393 ± 0.003	10.00 ± 0.08	0.393 ± 0.003
W	6.00 ± 0.08	0.236 ± 0.003	6.00 ± 0.08	0.236 ± 0.003
H	5.65 - 0.20	0.222 - 0.008	5.65 - 0.20	0.222 - 0.008
T	3.2	0.125	N/A	N/A
T1	N/A	N/A	7.50 ± 0.30	0.295 ± 0.011
T2	5.08 ± 0.10	0.200 ± 0.004	5.08 ± 0.10	0.200 ± 0.004
D1	3.20 ± 0.15	0.126 ± 0.006	3.20 ± 0.15	0.126 ± 0.006
D2	2.20 ± 0.15	0.087 ± 0.006	2.20 ± 0.15	0.087 ± 0.006
Tw	0.40	0.015	0.4	0.015
S	0.75	0.029	N/A	N/A

**SMT Version**  
**Gull Wings**

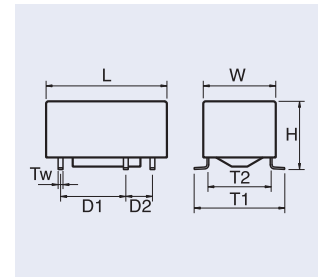

Coplanarity ≤ 0.1mm

**Mounting Hole Layout**

View onto the component side of the PCB (top view)

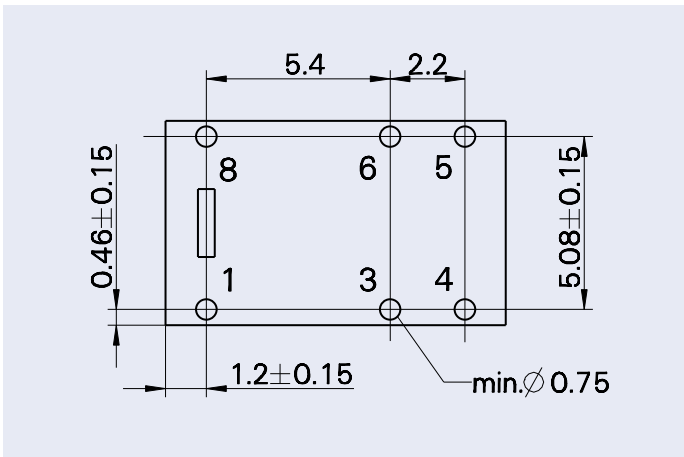

**Solder Pad Layout**

View onto the component side of the PCB (top view)

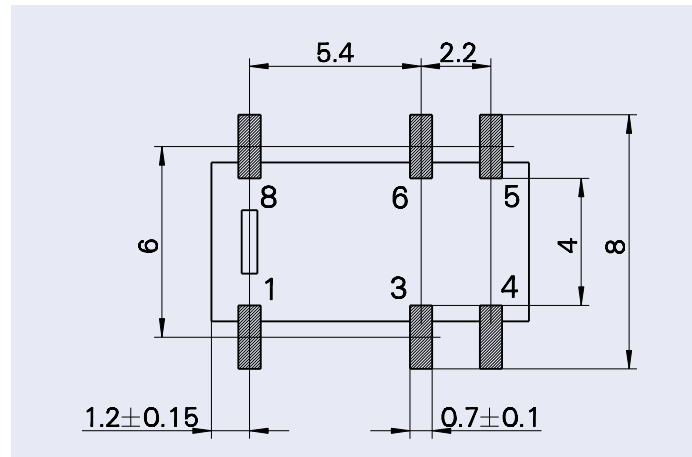

**Terminal Assignment**

Relay – top view

**Non-Latching Type**

not energized condition

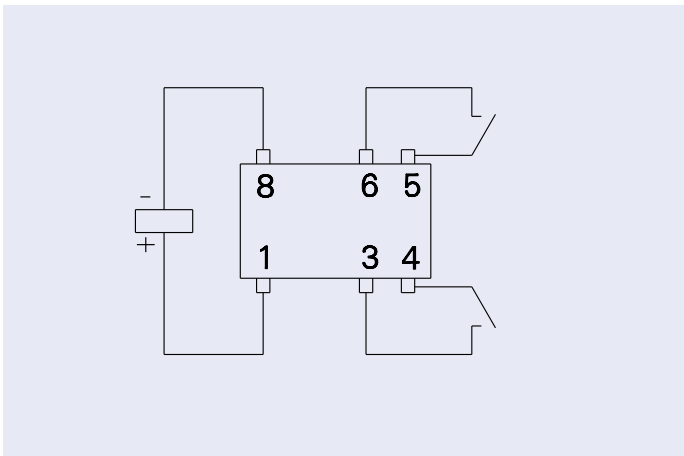

**Latching Type, 1 Coil**

reset condition

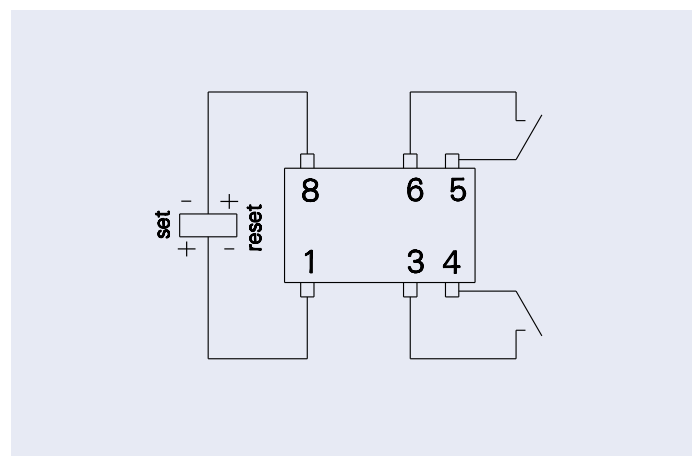

## IM-E Relay 2 Pole Make / 2 Form A / DPST NO

### Coil Data (values at 23 °C)

### Ordering Information

Nominal voltage $U_{nom}$	Operate/set voltage range		Release/ reset voltage Minimum	Coil power	Coil Resistance	Relay code	Tyco Electronics part number
	Minimum voltage $U_{min}$	Maximum voltage $U_{max}$					
Vdc	Vdc	Vdc	Vdc	mW	$\Omega / \pm 10 \%$		

### IM-E

#### SMT Gull Wings non-latching 1 coil

3	2.25	7.20	0.30	140	64	IME01GR	1462043-1
4.5	3.38	10.80	0.45	140	145	IME02GR	1462043-2
5	3.75	12.10	0.50	140	178	IME03GR	1462043-3
12	9.00	28.90	1.20	140	1029	IME06GR	1462043-4

#### THT non-latching 1 coil

3	2.25	7.20	0.30	140	64	IME01TS	1462043-5
4.5	3.38	10.80	0.45	140	145	IME02TS	1462043-6
5	3.75	12.10	0.50	140	178	IME03TS	1462043-7
12	9.00	28.90	1.20	140	1029	IME06TS	1462043-8

Further coil versions are available on request.

## IM Relay 2 Pole Changeover / 2 Form C / DPDT

### Contact Data

	Standard and "C" Version	"D" Version	"P" Version
Number of contacts and type	2 changeover contacts		
Contact assembly	Bifurcated contacts		
Contact material	Palladium-ruthenium, gold-covered	Silver-nickel, gold-covered	Palladium-ruthenium, gold-covered
Limiting continuous current at max. ambient temperature	2 A	5 A	2 A
Maximum switching current	2 A	5 A	2 A
Maximum switching voltage	220 Vdc 250 Vac		
Maximum switching capacity	60 W, 62.5 VA		
Thermoelectric potential	< 10 $\mu$ V		
Minimum switching voltage	100 $\mu$ V		
Initial contact resistance / measuring condition: 10 mA / 20 mV	< 50 m $\Omega$		
Electrical endurance at contact application 0 ( $\leq 30$ mV / $\geq 10$ mA) cable load open end	min. $2.5 \times 10^6$ operations min. $2.0 \times 10^6$ operations		
Resistive load at 125Vdc / 0.24 A - 30 W at 220 Vdc / 0.27 A - 60 W at 250 Vac / 0.25 A - 62.5 VA	min. $5 \times 10^5$ operations min. $1 \times 10^5$ operations min. $1 \times 10^5$ operations		
VA at 30 Vdc / 1 A - 30 W at 30 Vdc / 2 A - 60 W	min. $5 \times 10^5$ operations min. $1 \times 10^5$ operations		
Mechanical endurance	typ. $10^8$ operations		
UL contact ratings	220 Vdc / 0.24 A - 60 W 125 Vdc / 0.24 A - 30 W 250 Vac / 0.25 A - 62.5 VA 125 Vac / 0.5 A - 62.5 VA 30 Vdc / 2 A - 60 W		

### Max. DC Load Breaking Capacity

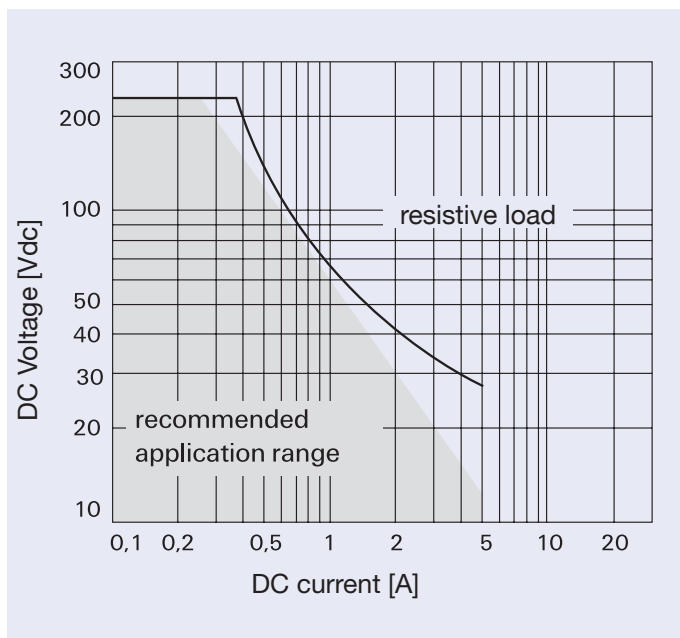

## IM Relay

### Contact Data

	IM-A	IM-B	IM-C	IM-D	IM-E
Number of contacts and type	1 Pole break	1 Pole make	1 Pole changeover	2 Pole break	2 Pole make
Contact assembly	Bifurcated contacts				
Contact material	Palladium-ruthenium, gold-covered				
Limiting continuous current at max. ambient temperature	2 A	2 A	4 A	2 A	2 A
Maximum switching current	2 A	2 A	3 A	2 A	2 A
Maximum switching voltage	220 Vdc 250 Vac				
Maximum switching capacity	60 W, 62.5 VA				
Thermoelectric potential	< 10 $\mu$ V				
Minimum switching voltage	100 $\mu$ V				
Initial contact resistance / measuring condition: 10 mA / 20 mV	< 100 m $\Omega$	< 100 m $\Omega$	NO < 100 m $\Omega$	< 50 m $\Omega$	< 50 m $\Omega$
Electrical endurance CC0 Contact category 0 ( $\leq$ 30 mV / $\geq$ 10 mA) cable load open end	min. $2.5 \times 10^6$ operations min. $2.0 \times 10^6$ operations				
Resistive load at 125 Vdc / 0.24 A - 30 W at 220 Vdc / 0.27 A - 60 W at 250 Vac / 0.25 A - 62.5 VA	min. $5 \times 10^5$ operations min. $1 \times 10^5$ operations min. $1 \times 10^5$ operations				
VA at 30 Vdc / 1 A - 30 W at 30 Vdc / 2 A - 60 W	min. $5 \times 10^5$ operations min. $1 \times 10^5$ operations				
Mechanical endurance	typ. $10^8$ operations				
UL contact ratings	220 Vdc / 0.24 A - 60 W 125 Vdc / 0.24 A - 30 W 250 Vac / 0.25 A - 62.5 VA 125 Vac / 0.5 A - 62.5 VA 30 Vdc / 2 A - 60 W				

### Max. DC Load Breaking Capacity

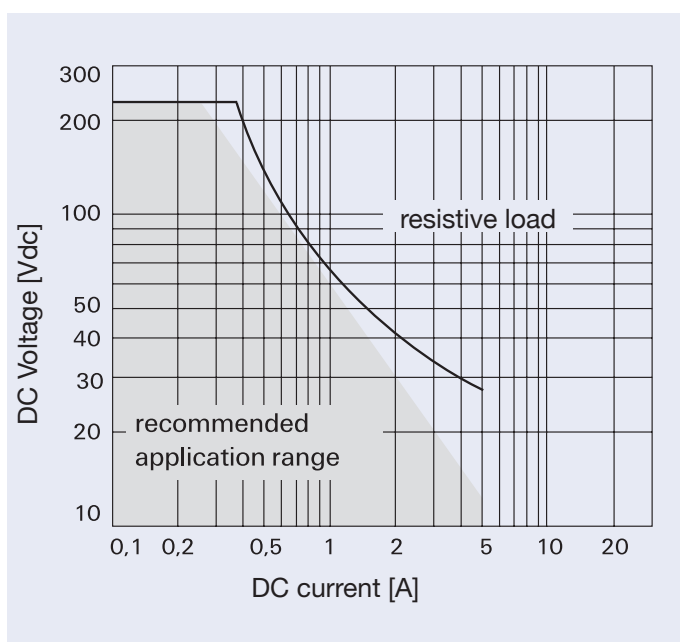

## IM Relay

### Insulation

IM Versions	Standard, Sensitive, Ultra High Sensitive Version	“C” Version High Dielectric	“D” Version High Current	“P” Version High Contact stability
Insulation resistance at 500 Vdc	> 10 <sup>9</sup> Ω	> 10 <sup>9</sup> Ω	> 10 <sup>9</sup> Ω	> 10 <sup>9</sup> Ω
Dielectric test voltage (1 min) between coil and contacts between adjacent contact sets between open contacts	1800 Vrms 1000 Vrms 1000 Vrms	1800 Vrms 1800 Vrms 1500 Vrms	1500 Vrms 750 Vrms 750 Vrms	1500 Vrms 750 Vrms 750 Vrms
Surge voltage resistance according to Telcordia TR-NWT-001089 (2/10 μs) between coil and contacts between adjacent contact sets between open contacts	2500 V 1500 V 1500 V	2500 V 2500 V 2500 V	2000 V 1000 V 1000 V	2000 V 1000 V 1000 V
according / EC 60950 (10/ 700 μs) between coil and contacts between adjacent contact sets between open contacts	2500 V 1500 V 1500 V	2500 V 2500 V 2500 V	2000 V 1000 V 1000 V	2000 V 1000 V 1000 V

IM Type	IM-A IM-B	IM-C	IM-D IM-E
Insulation resistance at 500 Vdc	> 10 <sup>9</sup> Ω	> 10 <sup>9</sup> Ω	> 10 <sup>9</sup> Ω
Dielectric test voltage (1 min) between coil and contacts between adjacent contact sets between open contacts	4000 Vrms - 2500 Vrms	1800 Vrms - 1000 Vrms	1800 Vrms 1000 Vrms 1000 Vrms
Surge voltage resistance according to Telcordia TR-NWT-001089 (2/10 μs) between coil and contacts between adjacent contact sets between open contacts	5600 V - 3500 V	2500 V - 1500 V	2500 V 1500 V 1500 V
according / EC 60950 (10/ 700 μs) between coil and contacts between adjacent contact sets between open contacts	5600 V - 3500 V	2500 V - 1500 V	2500 V 1500 V 1500 V

## IM Relay

### High Frequency Data

	IM-A / IM-B	IM / IM-D / IM-E	IMC
Capacitance between coil and contacts between adjacent contact sets between open contacts		max. 2 pF max. 2 pF max. 1 pF	
RF Characteristics Isolation at 100 MHz / 900 MHz Insertion loss at 100 MHz / 900 MHz V.S.W.R. at 100 MHz / 900 MHz	50 Ω - 33.0 dB / - 13.5 dB - 0.06 dB / - 1.00 dB 1.10 / 2.00	50 Ω - 37.0 dB / - 18.8 dB - 0.03 dB / - 0.33 dB 1.06 / 1.49	50 Ω - 35.0 dB / - 13.3 dB - 0.04 dB / - 0.40 dB 1.04 / 1.33

### General Data

Operate time at $U_{nom}$ typ. / max.	1 ms / 3 ms
Reset time (latching) at $U_{nom}$ , typ. / max.	1 ms / 3 ms
Duration of set / reset pulse (latching) min.	10ms*
Release time without diode in parallel (non-latching), typ. / max.	1 ms / 3 ms
Release time with diode in parallel (non-latching), typ. / max.	3 ms / 5 ms
Bounce time at closing contact, typ. / max.	1 ms / 5 ms
Maximum switching rate without load	50 operations/s
Ambient temperature	-40 °C ... +85 °C
Thermal resistance	< 150 K/W
Maximum permissible coil temperature	125 °C
Vibration resistance (function)	20 G 10 to 500 Hz
Shock resistance, half sinus, 11 ms	50 G (function)
Shock resistance, half sinus, 0.5 ms	500 G (damage)
Degree of protection / Environmental protection	immersion cleanable, IP 67 / RT V
Needle flame test	application time 20 s, no burning and glowing
Mounting position	any
Processing information	Ultrasonic cleaning is not recommended
Weight (mass)	max. 0.75 g
Terminal surface	NiPdAu
Moisture sensitive level (JEDEC J-STD-020D) - SMD types	MSL 3
Resistance to soldering heat	265 °C / 10 s

\* Duration may be shorter depending on pulse shape, voltage applied and ambiente temperature

All data refers to 23 °C unless otherwise specified.

## IM Relay

### Coil Operating Range

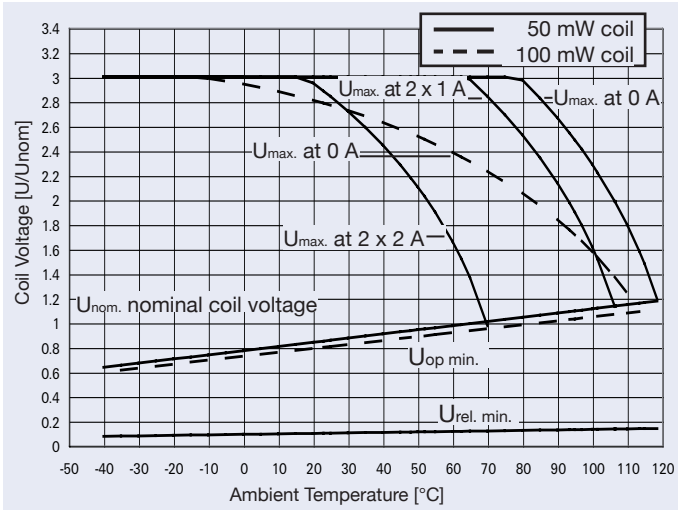

- $U_{nom}$  = Nominal coil voltage
- $U_{max.}$  = Upper limit of the operative range of the coil voltage (limiting voltage) when coils are continuously energized
- $U_{op. min.}$  = Lower limit of the operative range of the coil voltage (reliable operate voltage)  
For latching relays Uset min. resp. Ureset min.
- $U_{rel. min.}$  = Lower limit of the operative range of the coil voltage (reliable release voltage)

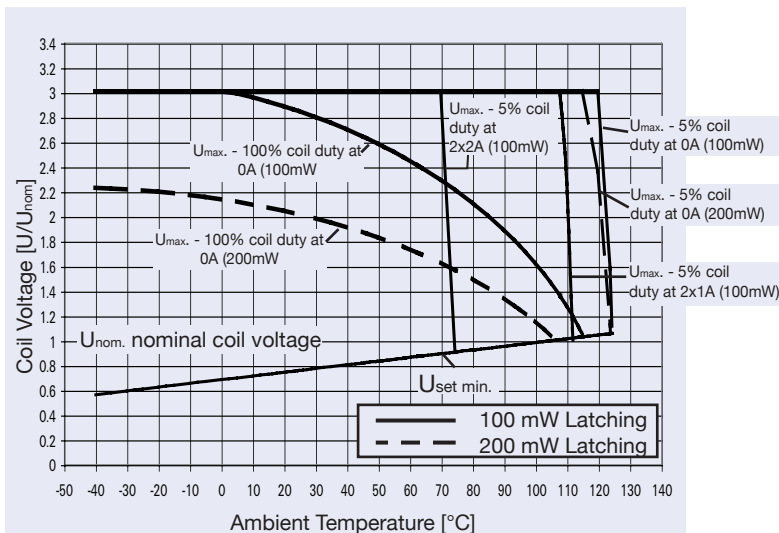
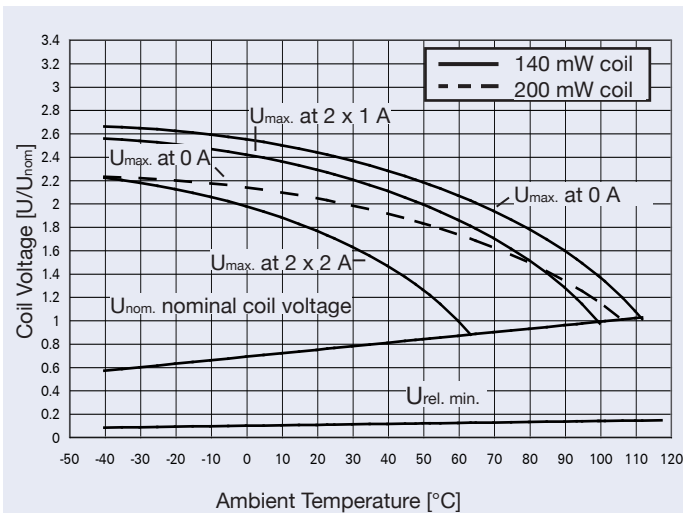





## IM Relay

### Packing

Dimensions in mm

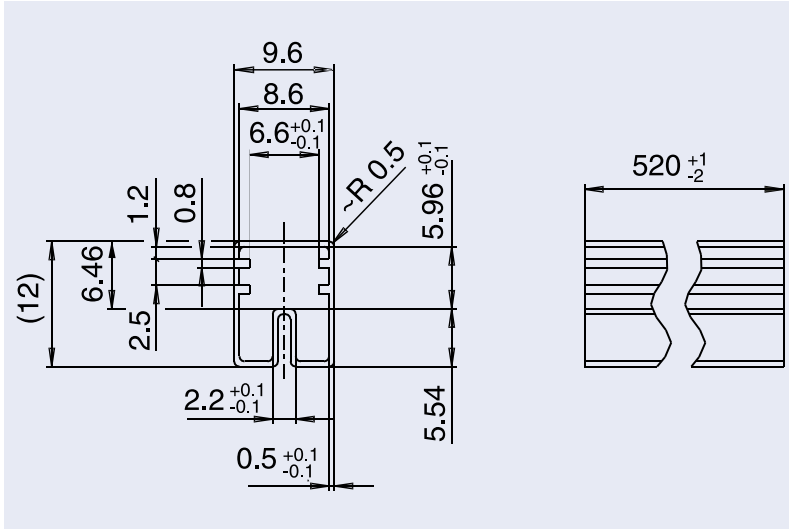

Tube for THT version  
50 relays per tube  
1,000 relays per box

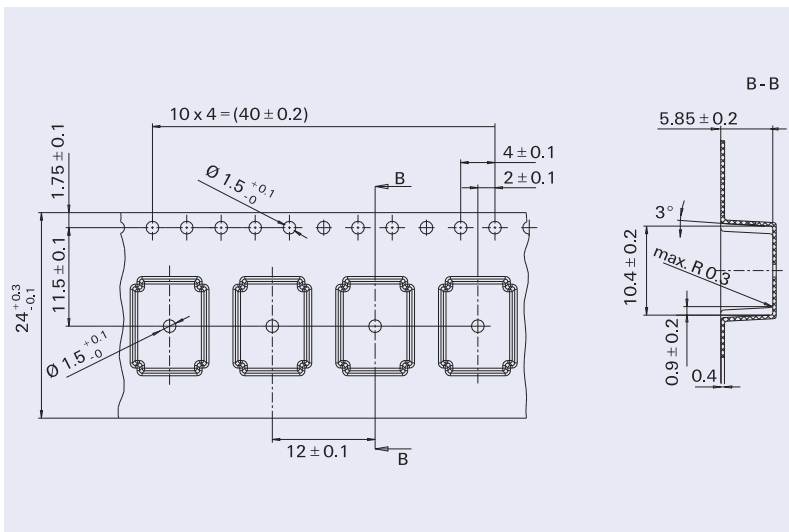

Tape and reel for SMT version  
1,000 relays per reel  
1,000 or 5,000 relays per box

### Reel Dimension

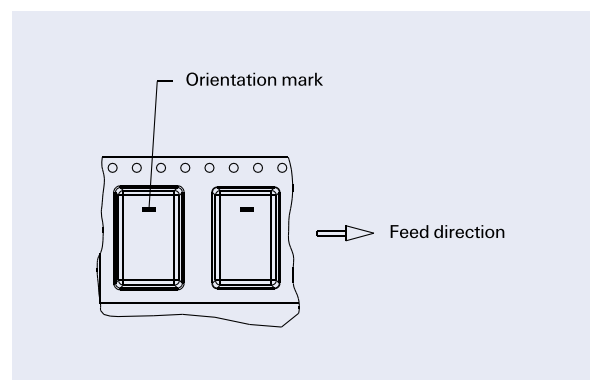
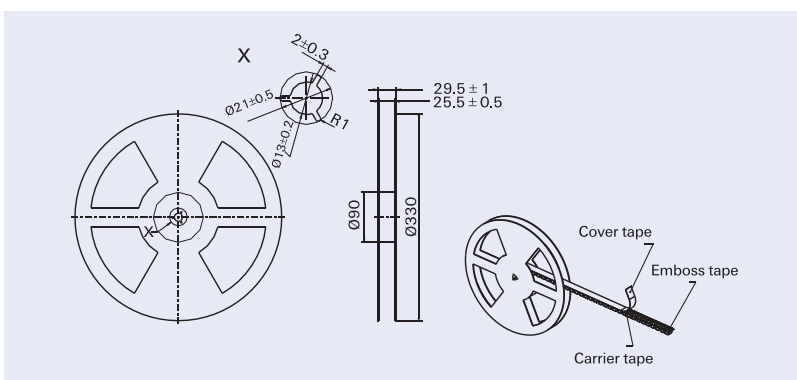

## IM Relay

### IM Relays

4th generation slim line – low profile polarized 2 c/o telecom signal relay with bifurcated contacts, available as non latching or latching relay with 1 coil. Nominal voltage range from 1.5 ... 24 V, coil power consumption of 50 ... 200 mW, latching relays with 1 coil 100 mW. The IM relay is available as through hole and surface mount type (J-Legs and Gull Wings) and capable to switch loads up to 60 W/62.5 VA. It is currently the only 2 A rated 4G relay on the market. Dielectric strength fulfills the Telcordia requirements according GR 1089 (2.5 kV – 2 / 10  $\mu$ s) and FCC part 68 (1.5 kV – 10 / 160  $\mu$ s). The IM relay is tested according CECC/IECQ and certified in accordance with IEC/EN 60950 and UL 60950. Dimensions approx. 10 x 6 mm board space and 5.65 mm height.

### P2 Relays

3rd generation polarized 2 c/o telecom relay with bifurcated contacts, available as non latching or latching relay with 1 or 2 coils. Nominal voltage range from 3 ... 24 V, coil power consumption 140 mW, latching relays with 1 coil 70 mW. The P2 Relay is available as through hole or surface mount type and capable to switch currents up to 5 A. Dielectric strength fulfills the Telcordia requirements according GR 1089 (2.5 kV – 2 / 10  $\mu$ s) and FCC part 68 (1.5 kV – 10 / 160  $\mu$ s). The P2 relay is tested according CECC/IECQ and certified in accordance with IEC/EN 60950 and UL 60950. Dimensions approx. 15 x 7,5 mm board space and 10 mm height.

### FX2 Relays

3rd generation polarized 2 c/o telecom relay with bifurcated contacts, available as non latching or latching relay with 1 coil. Nominal voltage range from 3 ... 48 V, coil power consumption of 80 ... 260 mW for the high sensitive version, 140... 300 mW for the standard version, latching relays with 1 coil 100 mW. The FX2 relay is available as through hole type and capable to switch loads up to 60 W/62.5 VA. Dielectric strength fulfills the Telcordia requirements according GR 1089 (2.5 kV – 2 / 10  $\mu$ s) and FCC part 68 (1.5 kV – 10 / 160  $\mu$ s). The FX2 relay is tested according CECC/IECQ and certified in accordance with IEC/EN 60950 and UL 60950. Dimensions approx. 15 x 7.5 mm board space and 10.7 mm height.

### FT2 / FU2 Relays

3rd generation non polarized, non latching 2 c/o telecom relay with bifurcated contacts. Nominal voltage range from 3 ... 48 V, coil power consumption 200 ... 300 mW. Most sensitive 48 V relay. Available as through hole and surface mount type. Dielectric strength fulfills the Telcordia requirements according GR 1089 (2.5 kV – 2 / 10  $\mu$ s) and FCC part 68 (1.5 kV – 10 / 160  $\mu$ s). The FT2/FU2 relay is tested according CECC/IECQ and certified in accordance with IEC/EN 60950 and UL 60950. Dimensions approx. 15 x 7.5 mm board space and 10 mm height.

### FP2 Relays

3rd generation polarized 2 c/o telecom relay with bifurcated contacts, available as non latching or latching relay with 1 or 2 coils. Nominal voltage range from 3 ... 48 V, coil power consumption of 80 ... 260 mW for the high sensitive version, 140... 300 mW for the standard version, latching relays with 1 coil 100 mW. The FP2 Relay is available as through hole type and capable to switch loads up to 60 W/62,5 VA. Dielectric strength fulfills FCC part 68 (1.5 kV – 10 / 160  $\mu$ s). The FP2 is tested according CECC/IECQ approved. Dimensions approx. 14 x 9 mm board space and 5 mm height.

### MT2

2nd generation non polarized, non latching 2 c/o telecom and signal relay with bifurcated contacts. Nominal voltage range from 3 ... 48 V, coil power consumption 150/200/300/400 and 550 mW. Dielectric strength fulfills the requirements according FCC part 68 (1.5 kV – 10 / 160  $\mu$ s). Dimensions approx. 20 x 10 mm board space and 11 mm height.

### D2n Relays

2nd generation non polarized 2 c/o relay for telecom and various other applications. Nominal voltage range from 3 ... 48 V, coil power consumption from 150 ... 500 mW. The D2n relay is capable to switch currents up to 3 A. Dielectric strength fulfills the requirements according FCC part 68 (1.5 kV – 10 / 160  $\mu$ s). Dimensions approx. 20 x10 mm board space and 11 mm height.

### P1 Relays

Extremely sensitive, polarized 1 c/o relay with bifurcated contacts for a wide range of applications, available as non latching or latching relay with 1 or 2 coils. Nominal voltage range from 3 ... 24 V, coil power consumption 65 mW, latching relays with 1 coil 30 mW. The P1 relay is available as through hole or surface mount type and capable to switch currents up to 1 A. Dielectric strength fulfills the requirements according FCC part 68 (1.5 kV – 10 / 160  $\mu$ s). Dimensions approx. 13 x 7.6 mm board space and 7 mm height for THT or 8 mm height for SMT version.

### W11 Relays

Low cost, non polarized 1 c/o relay for various applications. Nominal voltage range from 3 ... 24 V, coil power consumption 450 mW, sensitive versions 200 mW. The W11 relay is capable to switch currents up to 3 A. Dielectric strength 1000 Vrms. Dimensions approx. 15.6 x 10.6 mm board space and 11.5 mm height.

### Reed Relays

High sensitive, non polarized relay for telecom and various other applications, available with 1 n/o, 2 n/o or 1c/o contacts. Nominal voltage range from 5 ... 24 V, coil power consumption 50...280 mW for 1 n/o and 125 ... 280 mW for 2 n/o or 1 c/o versions. Reed relays are available in DIP or SIL housing and capable to switch currents up to 0.5 A. Integrated diode and/or electrostatic shield optional. Dielectric strength 1500 Vdc. Dimensions approx. 19.3 x 7 mm board space and 5 ... 7.5 mm height for DIP or 19.8 x 5 mm board space and 7.8 mm height for SIL version.

### Cradle Relays

Extremely reliable and mature relay family of 1st generation for various signal switching applications. Available as non polarized, polarized / latching and relay with AC coil. The benefit is the possibility of combining various contact sets from 1 up to 6 poles, single and bifurcated contacts, different contact materials with a coil voltage range from 1.5 Vdc to 220 Vac. Cradle relays are available as dust protected and hermetically sealed versions, with plug in or solder terminals and are capable to switch currents up to 5 A. Forcibly guided (linked) contact sets optional. Dielectric strength 500 Vrms. Dimensions from approx. 19 x 24 to 19 x 35 mm board space and 30 mm height.

### Other Relays

We offer a variety of different relay families for maintenance and replacement purposes. These relays are up to 50-plus years old now, such as Card Relay SN (V23030 series), Small General Purpose Relay (V23006 series), Small Polarized Relay (V23063 ... V23067 and V23163 ... V23167 series). Accessories like sockets, hold down springs, etc. optional.

### High Frequency Relays

HF3 / HF3S / HF6 series RF relays offering excellent RF characteristics in a small package. All HF series relays are suitable for SMD soldering processes. Available as non latching or latching versions with 1 or 2 coils and a nominal coil voltage range from 3 ... 24 V, a coil power consumption of 140 mW or 70 mW (single coil latching types).

HF3: Low cost RF relay suitable up to 3 GHz. Impedance 50 and 75 Ohm. 50 W hot switching and 50 W RF power carry capability. Dimensions 14.6 x 7.3 x 10.3 mm.

HF3S: High performance, high power RF relay suitable up to 3 GHz, 50 W hot switching and 150 W RF power carry capability. Dimensions 15 x 7.6 x 10.6 mm.

HF6: High performance, high power RF relay suitable up to 6 GHz, 50 W hot switching and 50 W RF power carry capability. Dimensions 15 x 7.6 x 10.6 mm.

**Tyco Electronics AMP GmbH**

Relay Products Group  
AMPèrestrasse 12-14  
64625 Bensheim  
Germany

AXICOM Signal Relay Contact Switzerland  
Phone: +41-(0)44-782-9111  
E-Mail: [axicom@tycoelectronics.com](mailto:axicom@tycoelectronics.com)

[www.tycoelectronics.com](http://www.tycoelectronics.com)  
<http://relays.tycoelectronics.com>

AXICOM, TE (logo) and Tyco Electronics  
are trademarks of the Tyco Electronics  
group of companies and its licensors.

©2010 Tyco Electronics Ltd.  
108-98001 Rev. M Revised 4-2010

