

SI-3000LSA Series Surface-Mount, Low Current Consumption, Low Dropout Voltage Linear Regulator ICs

Features

- Compact surface-mount package (SOP8)
- Output current: 1 A
- Low circuit current at output OFF: $I_q(\text{OFF}) \leq 1 \mu\text{A}$ ($V_c = 0 \text{ V}$)
- Low dropout voltage: $V_{\text{DIF}} \leq 0.8 \text{ V}$ (at $I_o = 1 \text{ A}$)
 $V_{\text{DIF}} \leq 1.2 \text{ V}$ ($I_o = 1 \text{ A}$) for SI-3018LSA
- 4 types of output voltages (1.8 V, 2.5 V, 3.3 V, 5.0 V) available
- Output ON/OFF control terminal voltage compatible with LS-TTL
- Built-in foldback-type-overcurrent and thermal protection circuits

Absolute Maximum Ratings

($T_a = 25^\circ\text{C}$)

Parameter	Symbol	Ratings	Unit
DC Input Voltage	V_{IN}	16	V
Output control terminal voltage	V_c	V_{IN}	V
DC Output Current	I_o	1	A
Power Dissipation	P_{D1}^{*1}	1.16	W
	P_{D2}^{*2}	1.1	W
Junction Temperature	T_{J}^{*3}	-30 to +150	$^\circ\text{C}$
Operating Ambient Temperature	T_{op}	-30 to +150	$^\circ\text{C}$
Storage Temperature	T_{stg}	-30 to +150	$^\circ\text{C}$
Thermal Resistance (Junction to Lead (pin 8))	$\theta_{\text{J-L}}$	36	$^\circ\text{C/W}$
Thermal Resistance (Junction to Ambient Air)	$\theta_{\text{J-a}}^{*2}$	100	$^\circ\text{C/W}$

- *1: When mounted on glass-epoxy board $56.5 \times 56.5 \text{ mm}$ (copper laminate area 100%).
- *2: When mounted on glass-epoxy board $40 \times 40 \text{ mm}$ (copper laminate area 100%).
- *3: Thermal protection circuits may be activated if the junction temperature exceeds 135°C .

Applications

- Auxiliary power supplies for PC
- Battery-driven electronic equipment

Recommended Operating Conditions

Parameter	Symbol	Ratings				Unit
		SI-3018LSA	SI-3025LSA	SI-3033LSA	SI-3050LSA	
DC Input Voltage Range	V_{IN}	3.1 to 3.5 ^{*1}	^{*2} to 3.5 ^{*1}	^{*2} to 5.2 ^{*1}	^{*2} to 8.0	V
DC Output Current Range	I_o	0 to 1				A
Operating Junction Temperature	T_{Jop}	-20 to +125				$^\circ\text{C}$
Operating Ambient Temperature	T_{aop}	-30 to +85				$^\circ\text{C}$

- *1: V_{IN} (max) and I_o (max) are restricted by the relation $P_{\text{D}} = (V_{\text{IN}} - V_o) \times I_o$. Please calculate these values referring to the reference data on page 15.
- *2: Refer to the Dropout Voltage parameter.

Electrical Characteristics

($T_a = 25^\circ\text{C}$, $V_c = 2\text{V}$ unless otherwise specified)

Parameter	Symbol	Ratings												Unit
		SI-3018LSA			SI-3025LSA			SI-3033LSA			SI-3050LSA			
		min.	typ.	max.	min.	typ.	max.	min.	typ.	max.	min.	typ.	max.	
Output Voltage	V_o	1.764	1.800	1.836	2.450	2.500	2.550	3.234	3.300	3.366	4.90	5.00	5.10	V
	Conditions	$V_{\text{IN}}=3.3\text{V}$, $I_o=0.5\text{A}$			$V_{\text{IN}}=3.3\text{V}$, $I_o=0.5\text{A}$			$V_{\text{IN}}=5\text{V}$, $I_o=0.5\text{A}$			$V_{\text{IN}}=6.5\text{V}$, $I_o=0.5\text{A}$			
Dropout Voltage	V_{DIF}	-			0.4			0.4			0.4			V
	Conditions	-			$I_o \leq 0.5\text{A}$			$I_o \leq 0.5\text{A}$			$I_o \leq 0.5\text{A}$			
	Conditions	0.6	1.2				0.8			0.8			0.8	
Line Regulation	ΔV_{LINE}	2			2			3			15			mV
	Conditions	$V_{\text{IN}}=3.1$ to 3.5V , $I_o=0.3\text{A}$			$V_{\text{IN}}=3.1$ to 3.5V , $I_o=0.3\text{A}$			$V_{\text{IN}}=4.5$ to 5.5V , $I_o=0.3\text{A}$			$V_{\text{IN}}=6$ to 7V , $I_o=0.3\text{A}$			
Load Regulation	ΔV_{LOAD}	10			10			10			30			mV
	Conditions	$V_{\text{IN}}=3.3\text{V}$, $I_o=0$ to 1A			$V_{\text{IN}}=3.3\text{V}$, $I_o=0$ to 1A			$V_{\text{IN}}=5\text{V}$, $I_o=0$ to 1A			$V_{\text{IN}}=6.5\text{V}$, $I_o=0$ to 1A			
Temperature Coefficient of Output Voltage	$\Delta V_o/\Delta T_a$	± 0.3			± 0.3			± 0.3			± 0.5			mV/ $^\circ\text{C}$
	Conditions	$V_{\text{IN}}=3.3\text{V}$, $I_o=5\text{mA}$, $T_{\text{J}}=0$ to 100°C			$V_{\text{IN}}=3.3\text{V}$, $I_o=5\text{mA}$, $T_{\text{J}}=0$ to 100°C			$V_{\text{IN}}=5\text{V}$, $I_o=5\text{mA}$, $T_{\text{J}}=0$ to 100°C			$V_{\text{IN}}=6.5\text{V}$, $I_o=5\text{mA}$, $T_{\text{J}}=0$ to 100°C			
Ripple Rejection	R_{REJ}	60			57			55			55			dB
	Conditions	$V_{\text{IN}}=3.3\text{V}$, $f=100$ to 120Hz			$V_{\text{IN}}=3.3\text{V}$, $f=100$ to 120Hz			$V_{\text{IN}}=5\text{V}$, $f=100$ to 120Hz			$V_{\text{IN}}=6.5\text{V}$, $f=100$ to 120Hz			
Quiescent Circuit Current	I_q	1.7			1.7			1.7			1.7			mA
	Conditions	$V_{\text{IN}}=3.3\text{V}$, $I_o=0\text{A}$			$V_{\text{IN}}=3.3\text{V}$, $I_o=0\text{A}$			$V_{\text{IN}}=5\text{V}$, $I_o=0\text{A}$			$V_{\text{IN}}=6.5\text{V}$, $I_o=0\text{A}$			
Circuit Current at Output OFF	$I_q(\text{OFF})$	1			1			1			1			μA
	Conditions	$V_{\text{IN}}=3.3\text{V}$, $I_o=0\text{A}$, $V_c=0\text{V}$			$V_{\text{IN}}=3.3\text{V}$, $I_o=0\text{A}$, $V_c=0\text{V}$			$V_{\text{IN}}=5\text{V}$, $I_o=0\text{A}$, $V_c=0\text{V}$			$V_{\text{IN}}=6.5\text{V}$, $I_o=0\text{A}$, $V_c=0\text{V}$			
Overcurrent Protection Starting Current ^{*1,3}	I_{S1}	1.2			1.2			1.2			1.2			A
	Conditions	$V_{\text{IN}}=3.3\text{V}$			$V_{\text{IN}}=3.3\text{V}$			$V_{\text{IN}}=5\text{V}$			$V_{\text{IN}}=6\text{V}$			
V_c Terminal	Control Voltage (Output ON) ^{*2}	2.0			2.0			2.0			2.0			V
	Control Voltage (Output OFF) ^{*2}	0.8			0.8			0.8			0.8			
	Control Current (Output ON)	40			40			40			40			μA
	Conditions	$V_c=2\text{V}$												
Control Current (Output OFF)	I_c , IH	0			0			0			0			μA
	Conditions	$V_c=0\text{V}$												

- *1: I_{S1} is specified at the 5% drop point of output voltage V_o on the condition that $V_{\text{IN}} = 3.3 \text{ V}$ (5 V for SI-3033LSA), and $I_o = 0.5 \text{ A}$.
- *2: Output is OFF when the output control terminal V_c is open. Each input level is equivalent to LS-TTL level. Therefore, the device can be driven directly by LS-TTLs.
- *3: These products cannot be used in the following applications. Because these applications require a certain current at start-up and so the built-in foldback-type overcurrent protection may cause errors during start-up stage.
 - (1) Constant current load
 - (2) Positive and negative power supply
 - (3) Series-connected power supply
 - (4) V_o adjustment by raising ground voltage

External Dimensions (SOP8)

(Unit : mm)

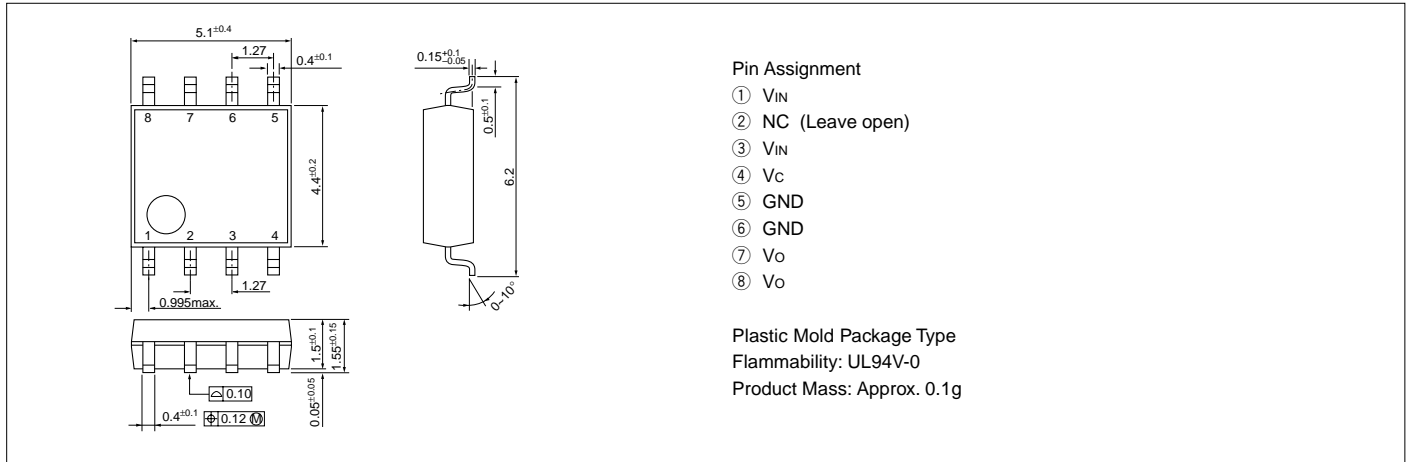

Block Diagram



Typical Connection Diagram

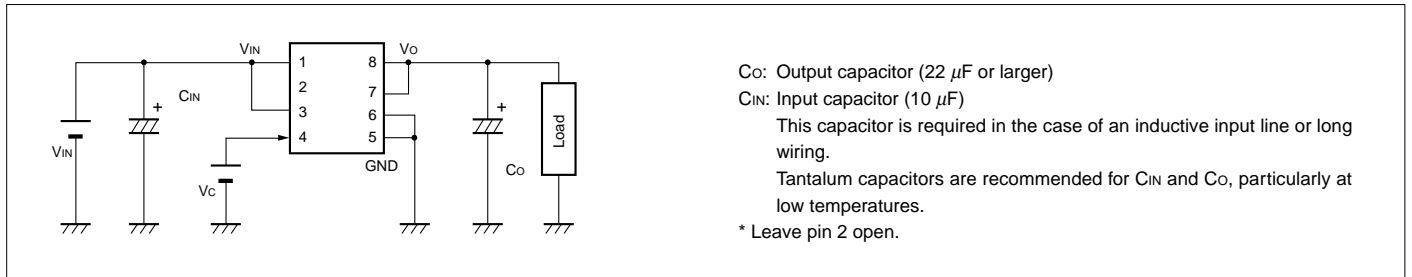

Reference Data

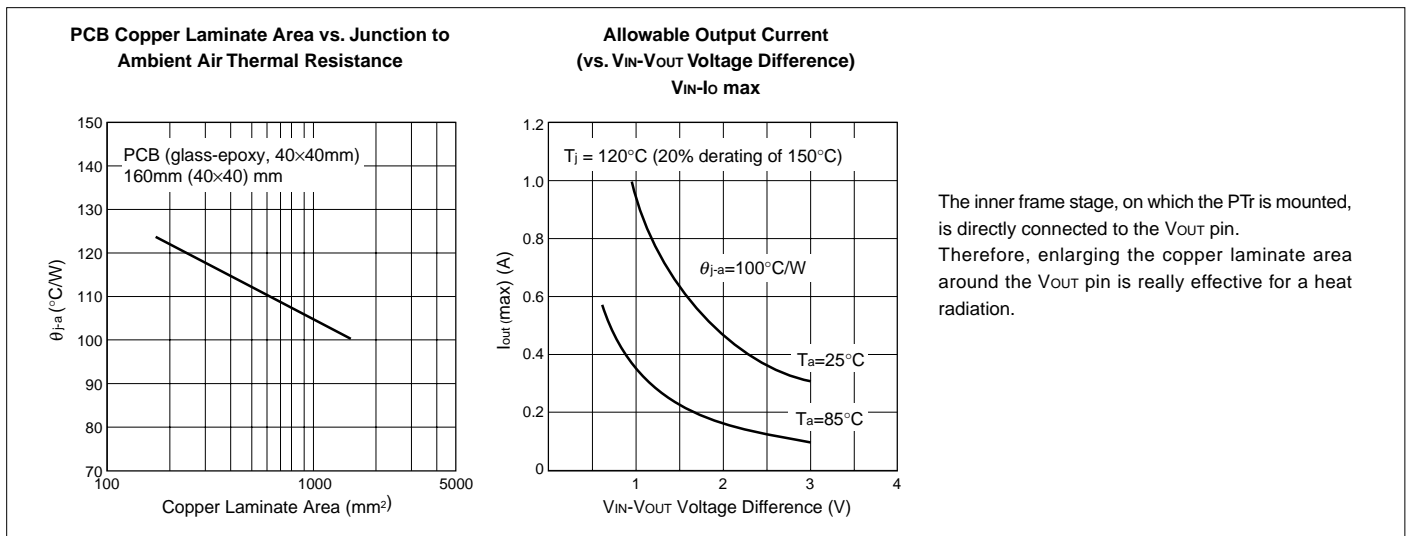

■Typical Characteristics of SI-3018LSA

($T_a=25^\circ\text{C}$)

I_o vs. V_{DIF} Characteristics

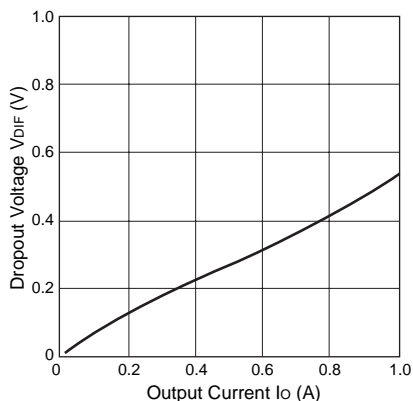

Load Regulation

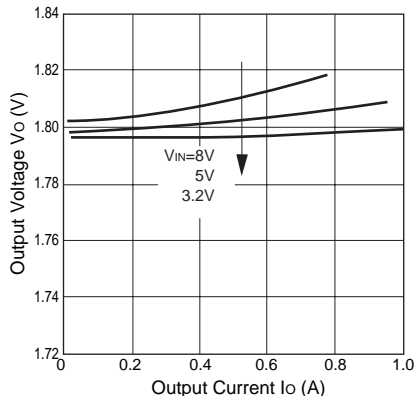

Output ON/OFF Control

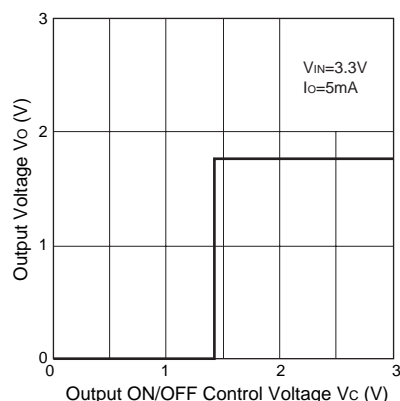

Output Voltage Characteristics

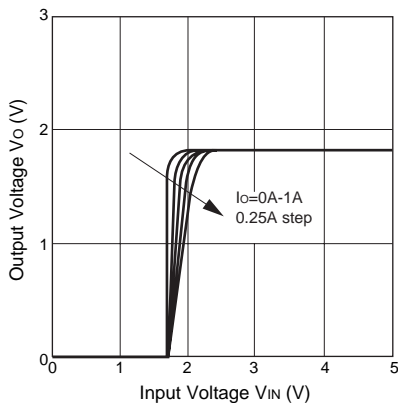

Overcurrent Protection Characteristics

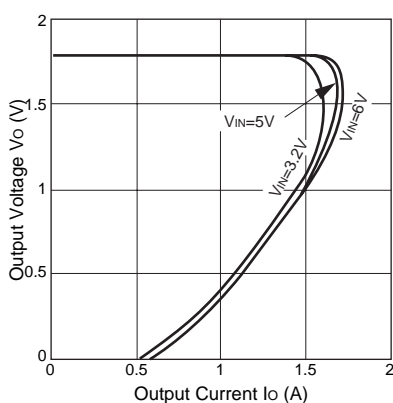

Output ON/OFF Control Current

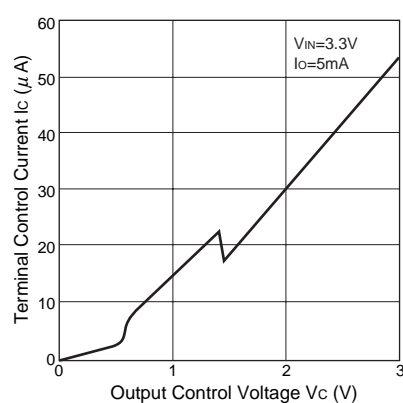

Line Regulation

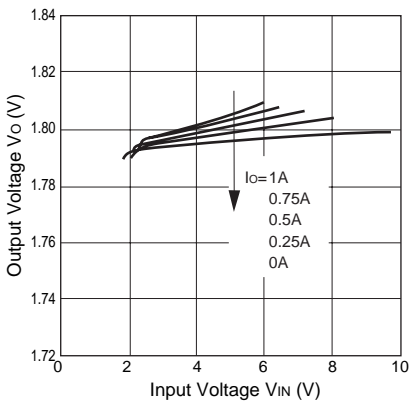

Thermal Protection Characteristics

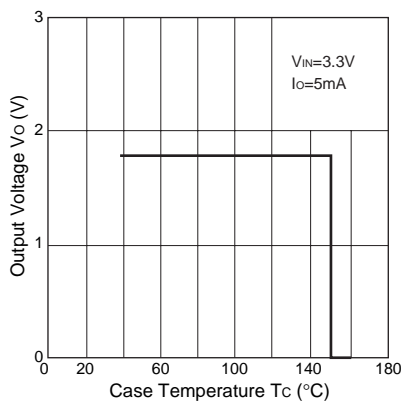

Circuit Current

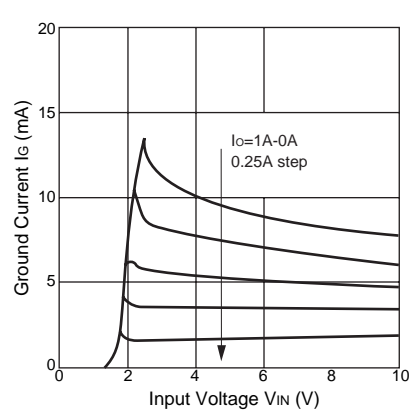

[Note on Thermal Protection]

The thermal protection circuit is intended for protection against heat during instantaneous short-circuiting. Its operation is not guaranteed for continuous heating conditions such as short-circuiting over extended periods of time.

■Typical Characteristics of SI-3025LSA

($T_a=25^\circ\text{C}$)

I_o vs. V_{DIF} Characteristics

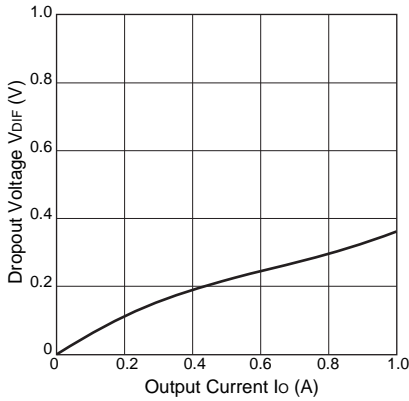

Load Regulation

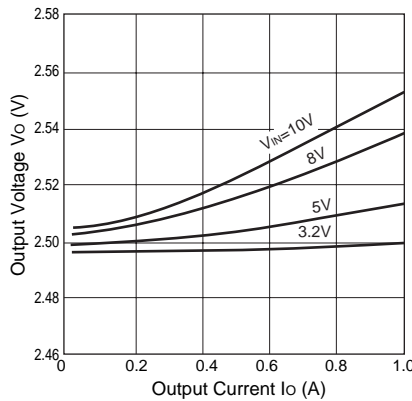

Output ON/OFF Control

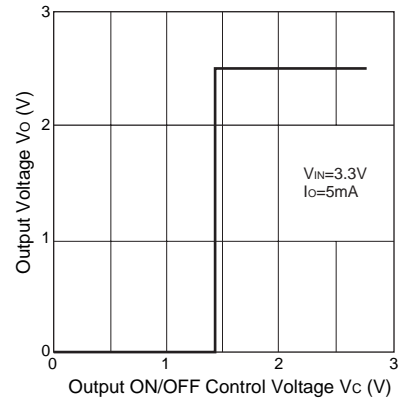

Output Voltage Characteristics

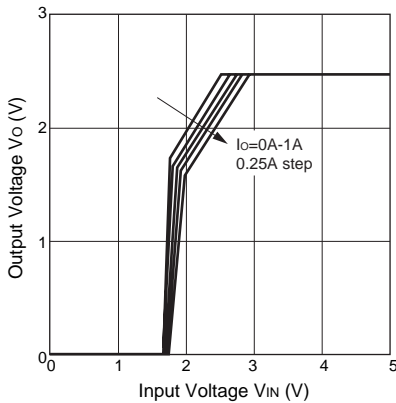

Overcurrent Protection Characteristics

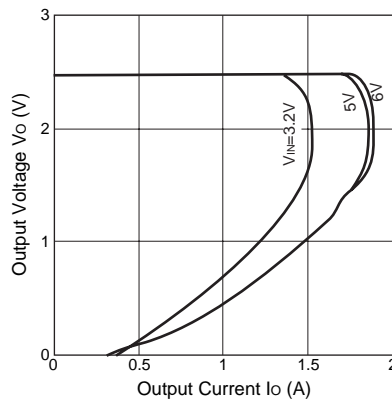

Output ON/OFF Control Current

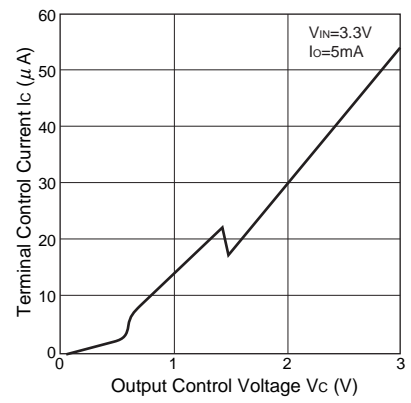

Line Regulation

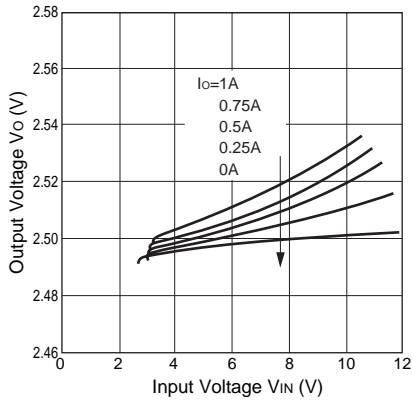

Thermal Protection Characteristics

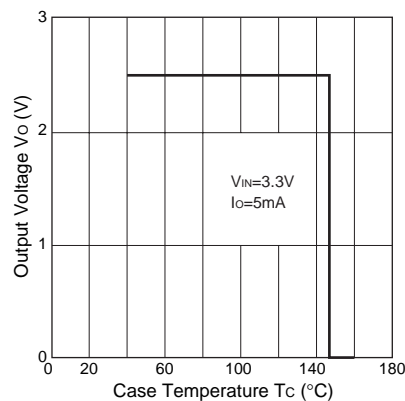

Circuit Current

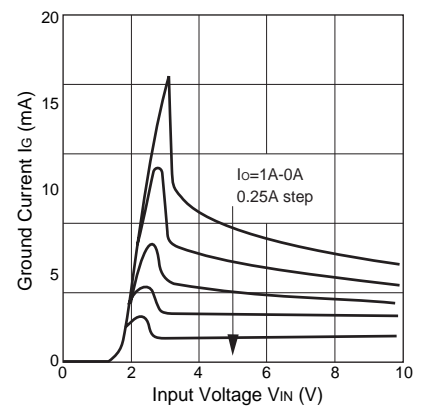

[Note on Thermal Protection]

The thermal protection circuit is intended for protection against heat during instantaneous short-circuiting. Its operation is not guaranteed for continuous heating conditions such as short-circuiting over extended periods of time.

■Typical Characteristics of SI-3033LSA

($T_a=25^\circ\text{C}$)

I_o vs. V_{DIF} Characteristics

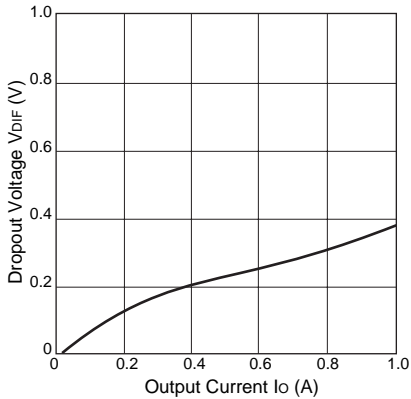

Load Regulation

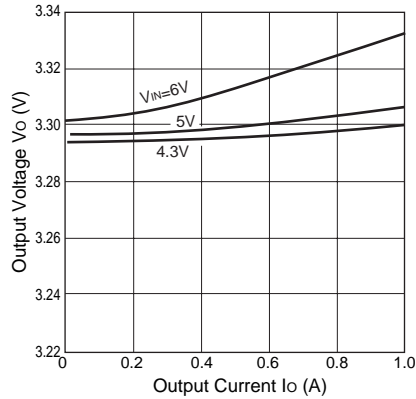

Output ON/OFF Control

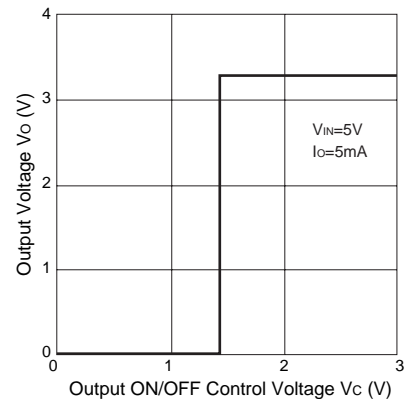

Output Voltage Characteristics

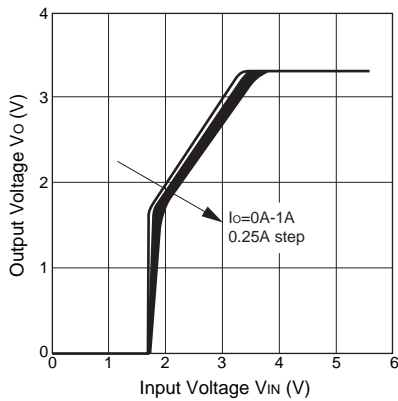

Overcurrent Protection Characteristics

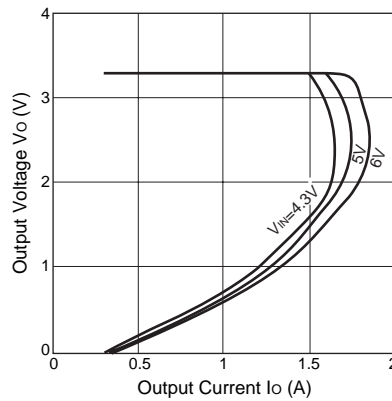

Output ON/OFF Control Current

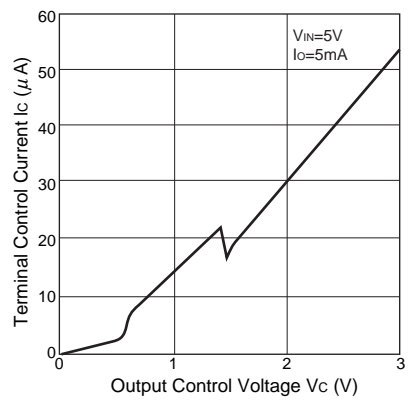

Line Regulation

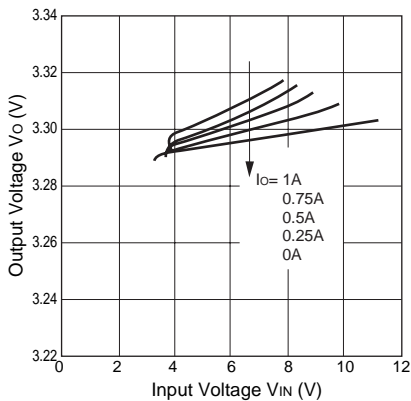

Thermal Protection Characteristics

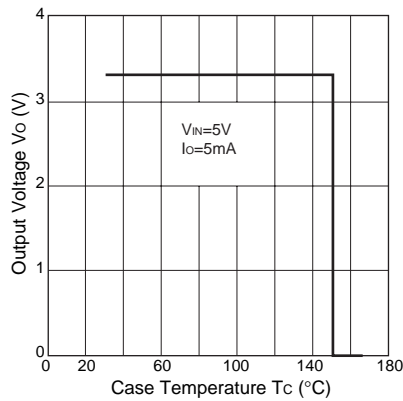

Circuit Current

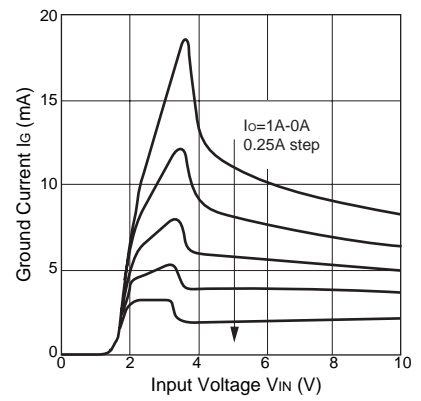

[Note on Thermal Protection]

The thermal protection circuit is intended for protection against heat during instantaneous short-circuiting. Its operation is not guaranteed for continuous heating conditions such as short-circuiting over extended periods of time.