

## ISOLATED DC/DC CONVERTERS

48 Vdc Input, 1.2 Vdc - 12 Vdc / 15 A - 3 A Outputs, 1/16 Brick Converter

**bel**  
POWER PRODUCTS

**xRSB-30T Series**

**RoHS Compliant**

**Rev.A**

- Isolated
- Fixed Frequency (550 kHz)
- High Efficiency
- High Power Density
- Low Cost
- Output Voltage Trim
- Input Under-Voltage Lockout
- Output Over-Voltage Shutdown
- OCP/SCP
- Over Temperature Protection
- Remote On/Off (Option)
- Positive/Negative Remote Sense
- Basic Insulation
- Through Hole and SMT(Option)
- UL60950-1 Recognized (UL/cUL)

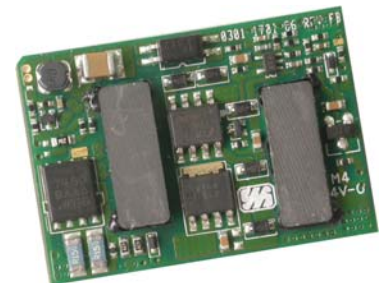

### Description

The xRSB-30T series are isolated dc/dc converters that operate from a nominal 48 Vdc source. These units will provide up to 30 W of output power from a nominal 48 Vdc input. These units are designed to be highly efficient and low cost. Features include remote on/off, over current protection and under voltage lockout. These converters are provided in an industry standard sixteenth brick package.

### Part Selection

Output Voltage	Input Voltage	Max. Output Current	Max. Output Power	Typical Efficiency	Model Number Active Low	Model Number Active High
1.2 Vdc	36 Vdc - 75 Vdc	15 A	18 W	84%	xRSB-30TV2L	xRSB-30TV20
1.5 Vdc	36 Vdc - 75 Vdc	13 A	19.5 W	86%	xRSB-30TV5L	xRSB-30TV50
1.8 Vdc	36 Vdc - 75 Vdc	13 A	23 W	86%	xRSB-30TV8L	xRSB-30TV80
2.5 Vdc	36 Vdc - 75 Vdc	10 A	25 W	89%	xRSB-30T02L	xRSB-30T025
3.3 Vdc	36 Vdc - 75 Vdc	10 A	30 W	90%	xRSB-30T03L	xRSB-30T033
5.0 Vdc	36 Vdc - 75 Vdc	7 A	35 W	90%	xRSB-30T05L	xRSB-30T050
12 Vdc	36 Vdc - 75 Vdc	3 A	36 W	89%	xRSB-30T12L	xRSB-30T120

**Notes:** 1. Add "G" suffix at the end of the model number to indicate Tray Packaging. Replace "x" with "S" to indicate SMT package, or "0" to indicate through hole package.

2. All part numbers above indicate RoHS 6. Change the second letter "R" to "7" for RoHS 5 part numbers

### Absolute Maximum Ratings

Parameter	Min	Typ	Max	Notes
Input Voltage (continuous)	-0.3 V	-	80 V	
Input Voltage Transient (100 ms)	-0.3 V	-	100 V	
Remote On/Off	-0.3 V	-	18 V	
I/O Isolation Voltage	-	-	1500 V	
Ambient Temperature	-40 °C	-	85 °C	
Storage Temperature	-55 °C	-	125 °C	

# ISOLATED DC/DC CONVERTERS

48 Vdc Input, 1.2 Vdc - 12 Vdc / 15 A - 3 A Outputs, 1/16 Brick Converter



## Input Specifications

Parameter	Min	Typ	Max	Notes
Input Voltage	36 V	48 V	75 V	
Input Current (full load)	-	-	1.6 A	
Input Current (no load)	-	30 mA	120 mA	
Remote Off Input Current	-	2 mA	6 mA	
Input Reflected Ripple Current (pk-pk)	-	20 mA	50 mA	Tested with simulated source impedance of 15 $\mu$ H, 5 Hz to 20 MHz; use a 100 $\mu$ F/100 V electrolytic capacitor with ESR=1 ohm max at 200 kHz at the input.
Input Reflected Ripple Current (rms)	-	3 mA	7 mA	
I <sup>2</sup> t Inrush Current Transient	-	0.01 A <sup>2</sup> s	0.02 A <sup>2</sup> s	
Turn On Voltage Threshold	31 V	33 V	35 V	
Turn Off Voltage Threshold	28 V	32 V	35 V	

**Note:** All specifications are typical at nominal input, full load at 25 °C unless otherwise stated.

## Output Specifications

Parameter	Min	Typ	Max	Notes
Output Voltage Set Point				Test conditions: Vin=48 V; Io=50% load
Vo=1.2 V	1.182 V	1.2 V	1.218 V	
Vo=1.5 V	1.478 V	1.5 V	1.523 V	
Vo=1.8 V	1.773 V	1.8 V	1.827 V	
Vo=2.5 V	2.463 V	2.5 V	2.538 V	
Vo=3.3 V	3.250 V	3.3 V	3.350 V	
Vo=5.0 V	4.900 V	5.0 V	5.100 V	
Vo=12 V	11.750 V	12.0 V	12.250 V	
Line Regulation				
Vo=1.2 - 1.8 V	-	±0.5 mV	±3 mV	
Vo=2.5 V	-	±2.0 mV	±6 mV	
Vo=3.3 V	-	±3.0 mV	±8 mV	
Vo=5.0 V	-	±4.0 mV	±9 mV	
Vo=12 V	-	±6.0 mV	±20 mV	
Load Regulation				
Vo=1.2 - 2.5 V	-	±3 mV	±5 mV	
Vo=3.3 - 5.0 V	-	±4 mV	±9 mV	
Vo=12 V	-	±5 mV	±10 mV	
Regulation Over Temperature (-40 °C to +85 °C)				
Vo=1.2 - 1.8 V	-	±7 mV	±15 mV	
Vo=2.5 - 3.3 V	-	±9 mV	±16 mV	
Vo=5.0 V	-	±15 mV	±30 mV	
Vo=12 V	-	±20 mV	±35 mV	
Output Current				
Vo=1.2 V	0 A	-	15 A	
Vo=1.5 V	0 A	-	13 A	
Vo=1.8 V	0 A	-	13 A	
Vo=2.5 V	0 A	-	10 A	
Vo=3.3 V	0 A	-	10 A	
Vo=5.0 V	0 A	-	7 A	
Vo=12 V	0 A	-	3 A	

# ISOLATED DC/DC CONVERTERS

48 Vdc Input, 1.2 Vdc - 12 Vdc / 15 A - 3 A Outputs, 1/16 Brick Converter



## Output Specifications (continued)

Parameter		Min	Typ	Max	Notes	
Current Limit Threshold	Vo=1.2 V	18 A	24 A	30 A		
	Vo=1.5 V	14 A	20 A	26 A		
	Vo=1.8 V	14 A	19 A	24 A		
	Vo=2.5 V	11 A	16 A	21 A		
	Vo=3.3 V	10.5 A	15.5 A	25 A		
	Vo=5.0 V	7.5 A	9.5 A	14 A		
	Vo=12 V	3.5 A	4.5 A	6 A		
Short Circuit Surge Transient		-	0.5 A <sup>2</sup> s	1 A <sup>2</sup> s		
Ripple and Noise (rms)	Vo=1.2 - 2.5 V	-	10 mV	20 mV	Tested at 0-20 MHz BW, with a 1 uF ceramic capacitor and a 10 uF Tantalum capacitor at the output.	
	Vo=3.3 V	-	15 mV	30 mV		
	Vo=5.0 - 12 V	-	30 mV	55 mV		
Ripple and Noise (pk-pk)	Vo=1.2 - 2.5 V	-	40 mV	70 mV		
	Vo=3.3 V	-	65 mV	110 mV		
	Vo=5.0 V	-	90 mV	150 mV		
	Vo=12 V	-	80 mV	140 mV		
Turn on Time		-	35 mS	70 mS		
Overshoot at Turn on		-	0%	5%		
Output Capacitance	Vo=1.2 - 1.5 V	220 uF	-	15000 uF		
	Vo=1.8 V	220 uF	-	10000 uF		
	Vo=2.5 V	220 uF	-	6800 uF		
	Vo=3.3 V	0 uF	-	4700 uF		
	Vo=5.0 V	0 uF	-	2200 uF		
	Vo=12 V	0 uF	-	330 uF		
<b>Transient Response</b>						
25% ~ 50% Max Load	Overshoot	Vo=1.2 V	-	100 mV	150 mV	Test conditions: di/dt = 0.1 A/uS, Vin=48 V, with a 1uF ceramic capacitor and a 10 uF Tantalum capacitor at the output.
	Settling Time		-	100 uS	150 uS	
50% ~ 25% Max Load	Overshoot	Vo=1.5 - 1.8 V	-	100 mV	150 mV	
	Settling Time		-	100 uS	150 uS	
25% ~ 50% Max Load	Overshoot	Vo=1.5 - 1.8 V	-	150 mV	200 mV	
	Settling Time		-	120 uS	200 uS	
50% ~ 25% Max Load	Overshoot	Vo=1.5 - 1.8 V	-	150 mV	200 mV	
	Settling Time		-	120 uS	200 uS	
25% ~ 50% Max Load	Overshoot	Vo=2.5 V	-	200 mV	300 mV	
	Settling Time		-	100 uS	150 uS	
50% ~ 25% Max Load	Overshoot	Vo=2.5 V	-	200 mV	300 mV	
	Settling Time		-	100 uS	150 uS	
25% ~ 50% Max Load	Overshoot	Vo=3.3 V	-	200 mV	350 mV	
	Settling Time		-	200 uS	350 uS	
50% ~ 25% Max Load	Overshoot	Vo=3.3 V	-	200 mV	350 mV	
	Settling Time		-	200 uS	350 uS	
25% ~ 50% Max Load	Overshoot	Vo=5.0 V	-	350 mV	500 mV	
	Settling Time		-	200 uS	350 uS	
50% ~ 25% Max Load	Overshoot	Vo=5.0 V	-	350 mV	500 mV	
	Settling Time		-	200 uS	350 uS	
25% ~ 50% Max Load	Overshoot	Vo=12 V	-	270 mV	450 mV	
	Settling Time		-	110 uS	200 uS	
50% ~ 25% Max Load	Overshoot	Vo=12 V	-	270 mV	450 mV	
	Settling Time		-	110 uS	200 uS	

## ISOLATED DC/DC CONVERTERS

48 Vdc Input, 1.2 Vdc - 12 Vdc / 15 A - 3 A Outputs, 1/16 Brick Converter



**Note:** All specifications are typical at nominal input, full load at 25 °C unless otherwise stated.

### General Specifications

Parameter	Min	Typ	Max	Notes
Efficiency				
Vo=1.2 V	81%	84%	-	Vin=48 V, full load
Vo=1.5 V	83%	86%	-	
Vo=1.8 V	83%	86%	-	
Vo=2.5 V	84%	87%	-	
Vo=3.3 - 5.0 V	87%	90%	-	
Vo=12 V	86%	89%	-	
Switching Frequency	500 kHz	550 kHz	600 kHz	
Isolation Capacitance	-	3900 pF	-	
Output Voltage Trim Range	90% Vo	-	110% Vo	
Over Temperature Protection	120 °C	-	140 °C	
Over Voltage Protection	-	130% Vo	160% Vo	Test conditions: Vin=48 V, full load and short the feedback optocoupler.
MTBF	TBD			Calculated Per Bell Core SR-332 (Io = Nominal; Ta = 25 °C)
Dimensions				SMT Package
Inches (L x W x H)	1.3 x 0.9 x 0.364			
Millimeters (L x W x H)	33.02 x 22.86 x 9.24			
Dimensions				Through Hole Package
Inches (L x W x H)	1.3 x 0.9 x 0.378			
Millimeters (L x W x H)	33.02 x 22.86 x 9.60			
Weight	-	13 g	-	

**Note:** All specifications are typical at 25 °C unless otherwise stated.

### Control Specifications

Parameter	Min	Typ	Max	Notes	
<b>Remote On/Off</b>					
Signal Low (Unit On)	-0.3 V	-	0.8 V	When Remote On/Off pin is open, for active low option, unit is off; for active high option, unit is on	
Signal High (Unit Off)					2.95 V
Signal Low (Unit Off)	-0.3 V	-	0.8 V		
Signal High (Unit On)					2.95 V
Current Sink	-	0 mA	-		1 mA

## ISOLATED DC/DC CONVERTERS

48 Vdc Input, 1.2 Vdc - 12 Vdc / 15 A - 3 A Outputs, 1/16 Brick Converter

**bel**  
POWER PRODUCTS

### Output Trim Equations

Equations for calculating the trim resistor are shown below (Unit: kΩ). The Trim Down resistor should be connected between the Trim pin and Ground pin. The Trim Up resistor should be connected between the Trim pin and the Vout. Only one of the resistors should be used for any given application.

#### 1) Trim Equations for Vo=1.2 V

$$R_{trimdown} = \frac{511}{|\delta|} - 10.22$$

$$R_{trimup} = \frac{(100 + \delta) \cdot V_o \cdot 5.11 - 313}{0.6125 \cdot \delta} - 10.22$$

**Note:** 
$$\delta = \frac{(V_o_{req} - V_o)}{V_o} \times 100[\%]$$

V<sub>o\_req</sub>=Desired (trimmed) output voltage [V] V<sub>o</sub>=1.202 V

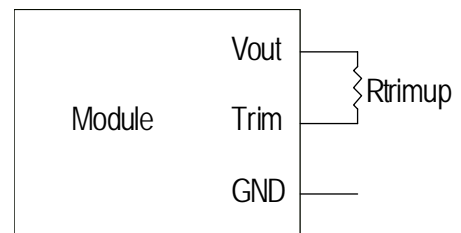
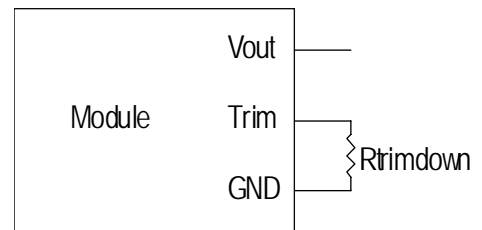

#### 2) Trim Equations for Vo=1.5 V - 12 V

$$R_{trimdown} = \frac{511}{|\delta|} - 10.22$$

$$R_{trimup} = \frac{(100 + \delta) \cdot V_o \cdot 5.11 - 626}{1.225 \cdot \delta} - 10.22$$

**Note:** 
$$\delta = \frac{(V_o_{req} - V_o)}{V_o} \times 100[\%]$$

V<sub>o\_req</sub>=Desired (trimmed) output voltage [V]

V<sub>o</sub>=1.503 V for 1.5 V output; V<sub>o</sub>=1.804 V for 1.8 V output; V<sub>o</sub>=2.505 V for 2.5 V output; V<sub>o</sub>=3.308 V for 3.3 V output; V<sub>o</sub>=5.002 V for 5 V output; V<sub>o</sub>=12.007 V for 12 V output.

# ISOLATED DC/DC CONVERTERS

48 Vdc Input, 1.2 Vdc - 12 Vdc / 15 A - 3 A Outputs, 1/16 Brick Converter



## Efficiency Data

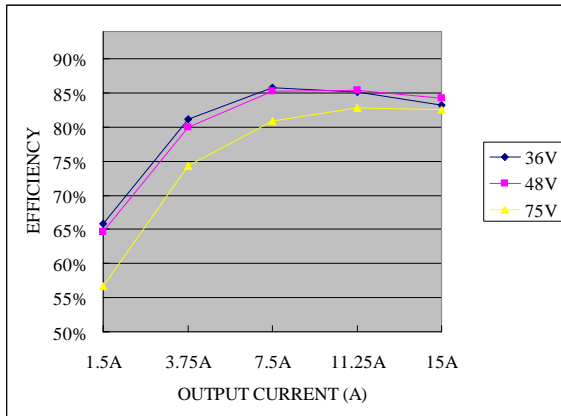

Vo=1.2 V

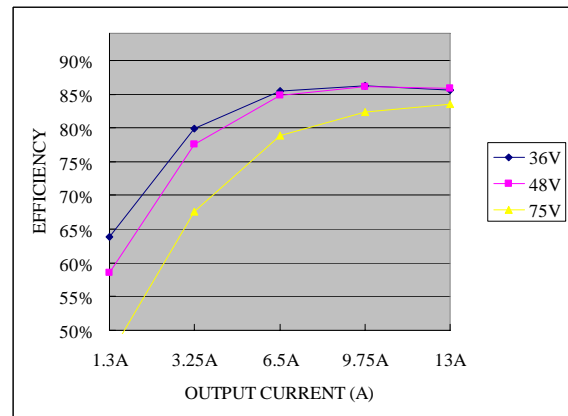

Vo=1.5 V

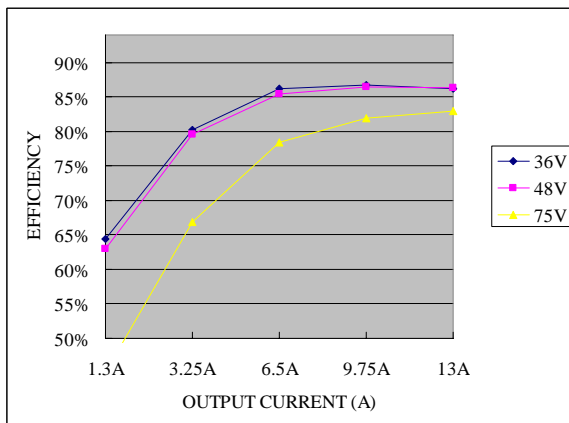

Vo=1.8 V

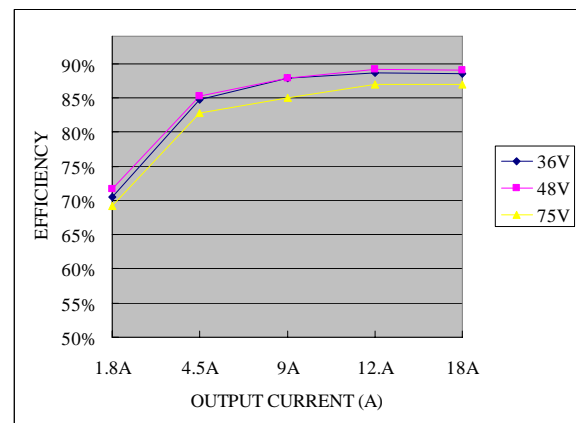

Vo=2.5 V

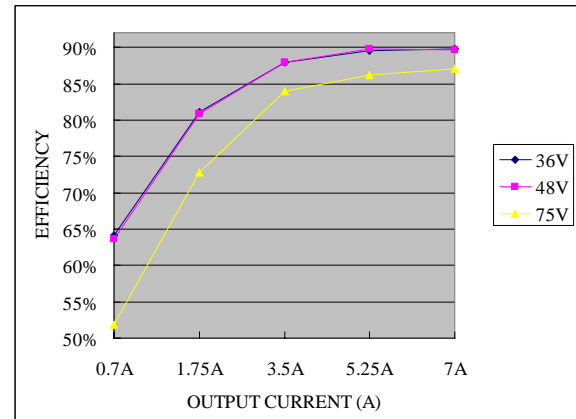
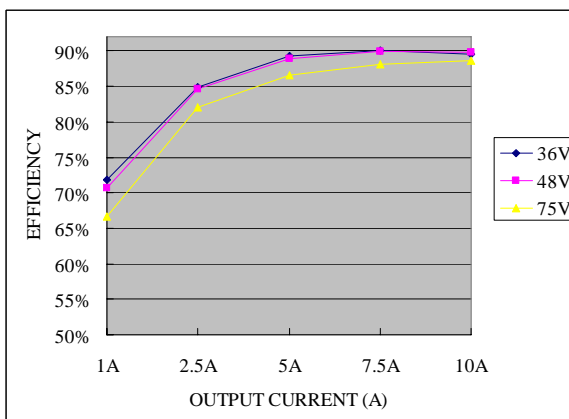

# ISOLATED DC/DC CONVERTERS

48 Vdc Input, 1.2 Vdc - 12 Vdc / 15 A - 3 A Outputs, 1/16 Brick Converter



Vo=3.3 V

Vo=5.0 V

## Efficiency Data (continued)

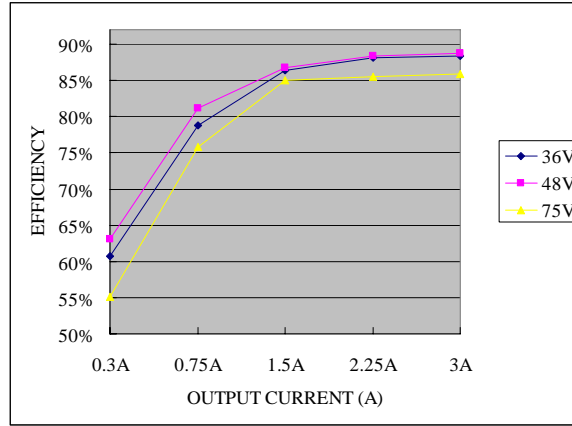

Vo=12 V

## Thermal Derating Curves

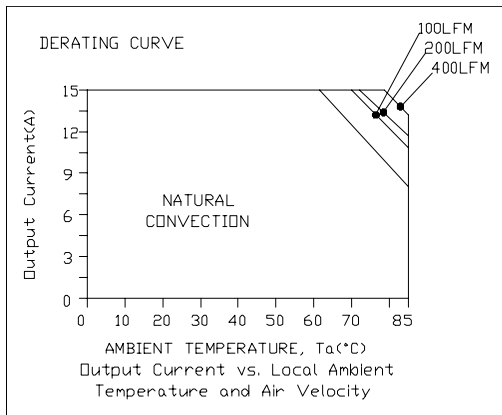

Vin=48 V, Vo=1.2 V

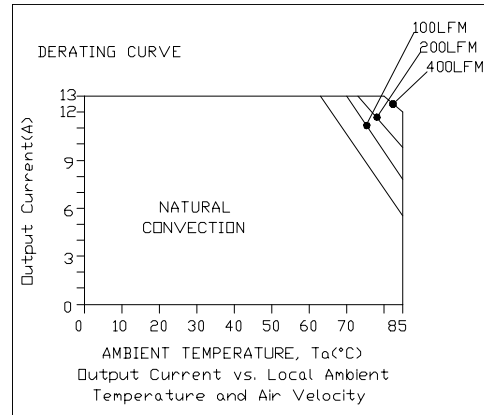

Vin=48 V, Vo=1.5 V

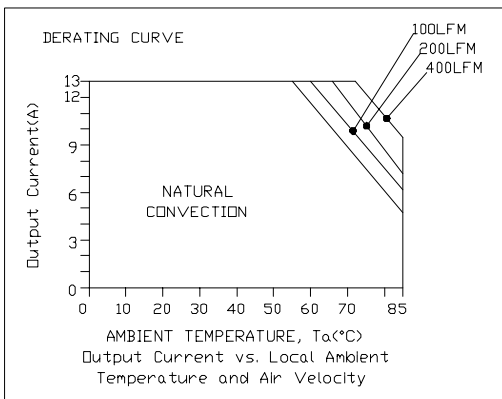

Vin=48 V, Vo=1.8 V

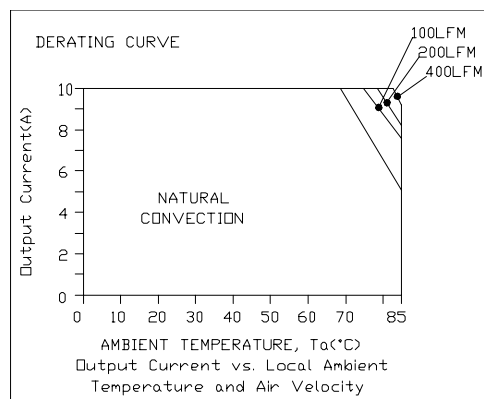

Vin=48 V, Vo=2.5 V

# ISOLATED DC/DC CONVERTERS

48 Vdc Input, 1.2 Vdc - 12 Vdc / 15 A - 3 A Outputs, 1/16 Brick Converter



## Thermal Derating Curves (continued)

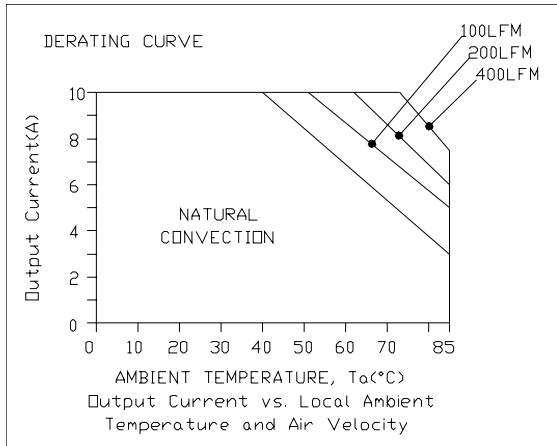

Vin=48 V, Vo=3.3 V

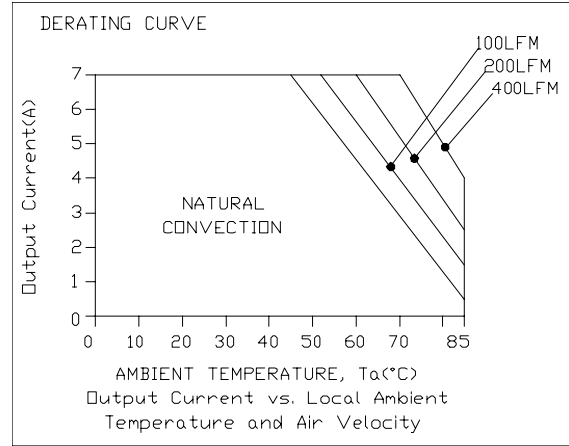

Vin=48 V, Vo=5.0 V

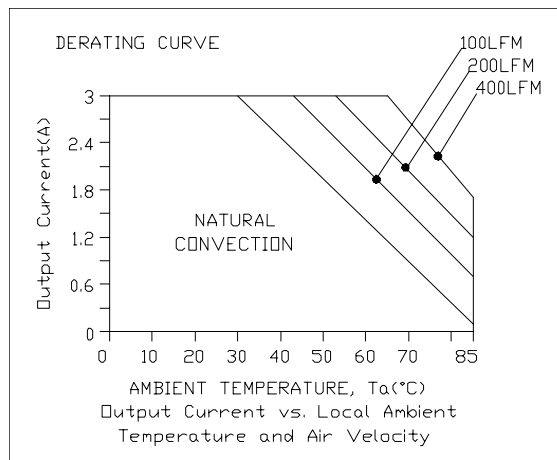

Vin=48 V, Vo=12 V



# ISOLATED DC/DC CONVERTERS

48 Vdc Input, 1.2 Vdc - 12 Vdc / 15 A - 3 A Outputs, 1/16 Brick Converter



## Ripple and Noise Waveforms

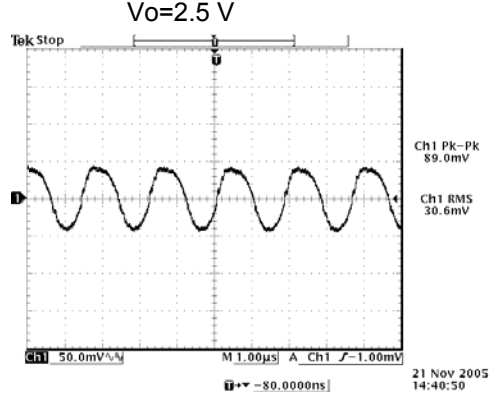
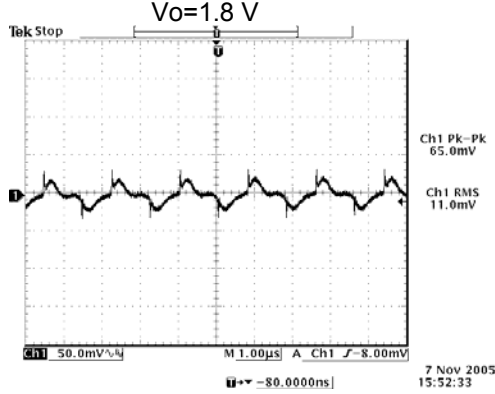
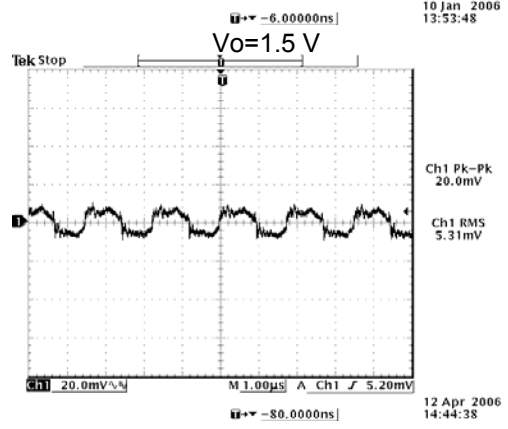
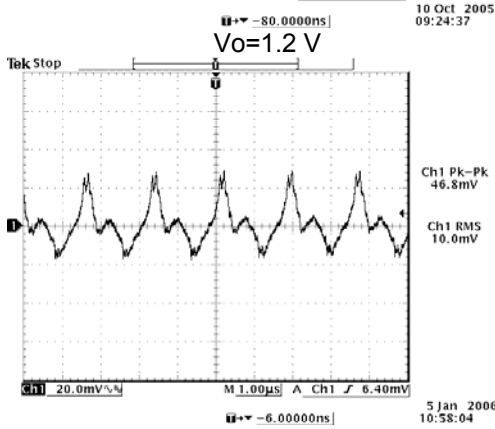
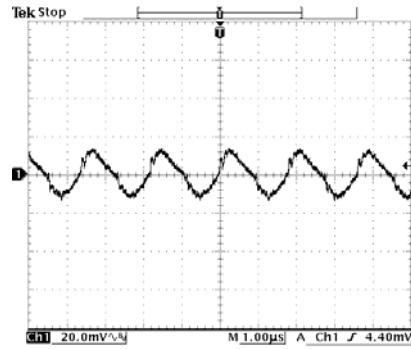
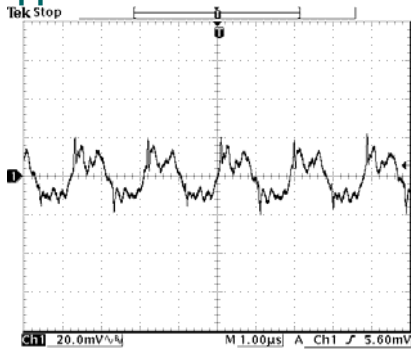

Vo=3.3 V

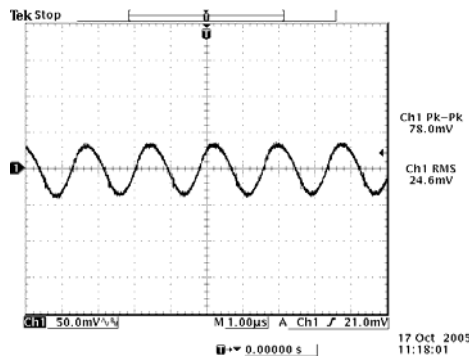

Vo=5.0 V

Vo=12 V

**Note:** Ripple and noise at full load, 48 V input, with a 1  $\mu$ F ceramic capacitor and a 10  $\mu$ F tantalum cap at the output, and  $T_a=25$  deg C.

# ISOLATED DC/DC CONVERTERS

48 Vdc Input, 1.2 Vdc - 12 Vdc / 15 A - 3 A Outputs, 1/16 Brick Converter



## Transient Response Waveforms

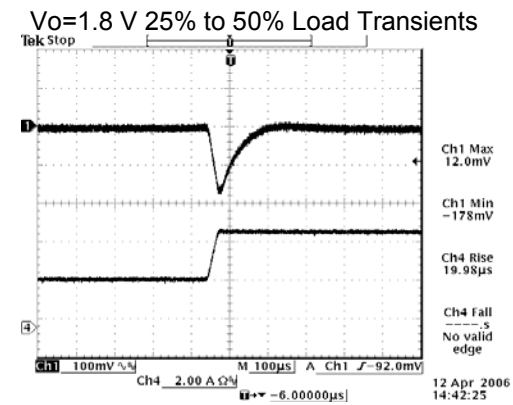
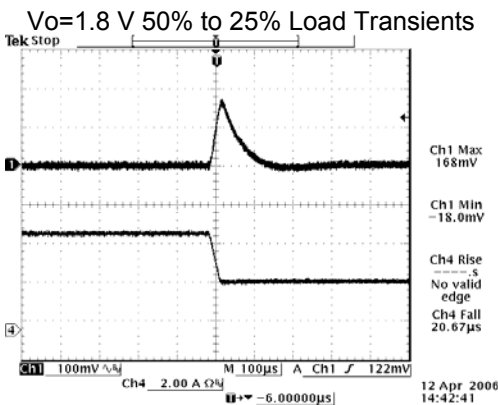
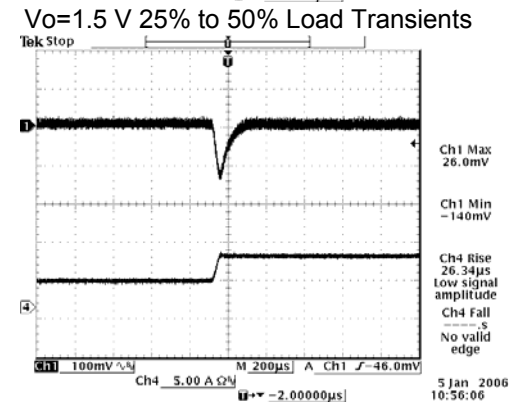
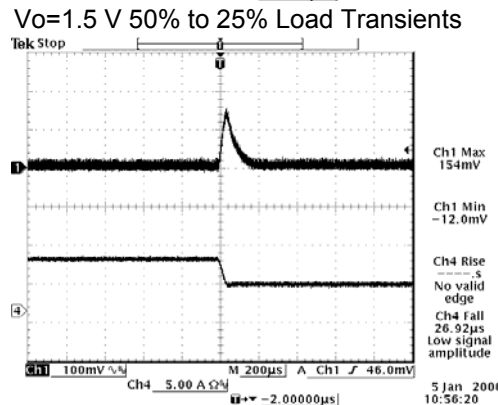
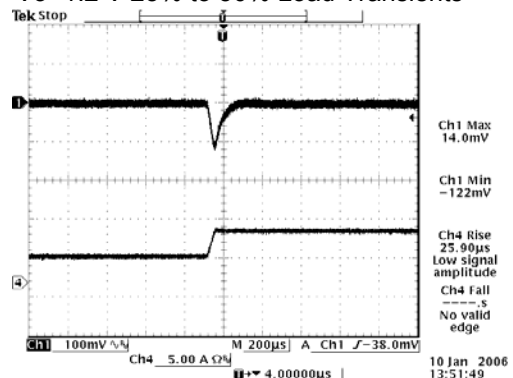
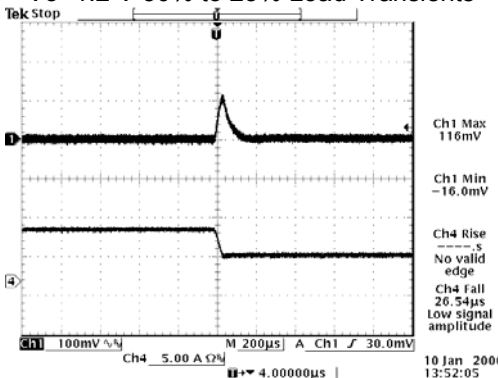
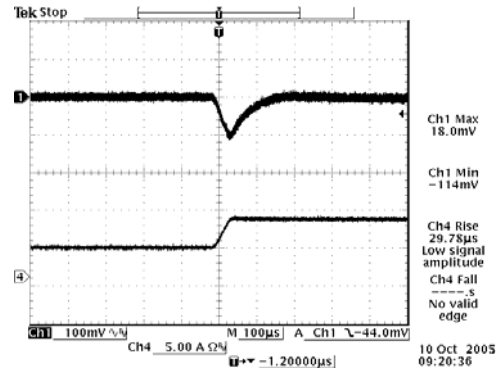
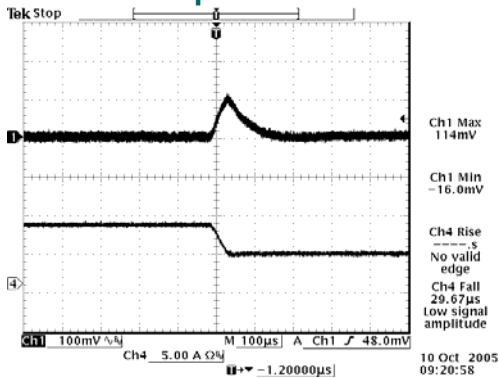

# ISOLATED DC/DC CONVERTERS

48 Vdc Input, 1.2 Vdc - 12 Vdc / 15 A - 3 A Outputs, 1/16 Brick Converter



## Transient Response Waveforms (continued)

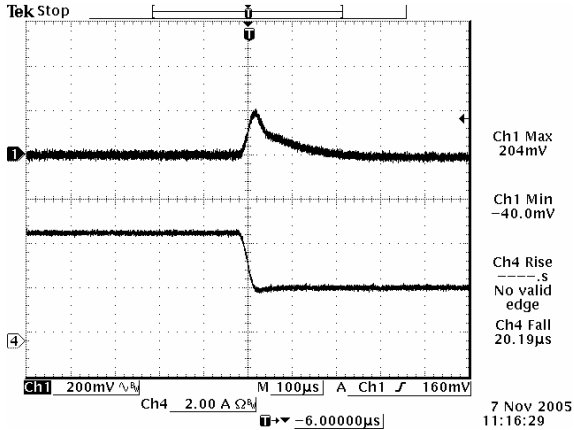

Vo=3.3 V 50% to 25% Load Transients

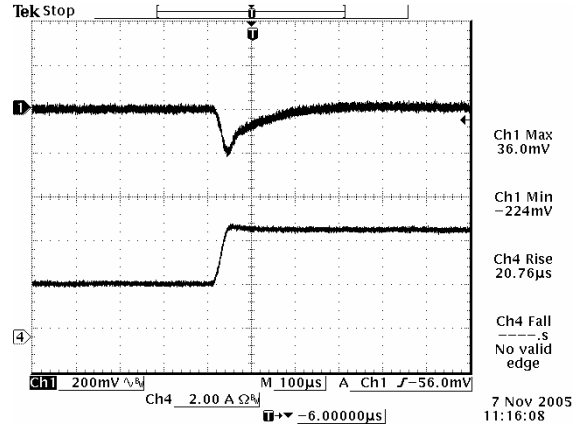

Vo=3.3 V 25% to 50% Load Transients

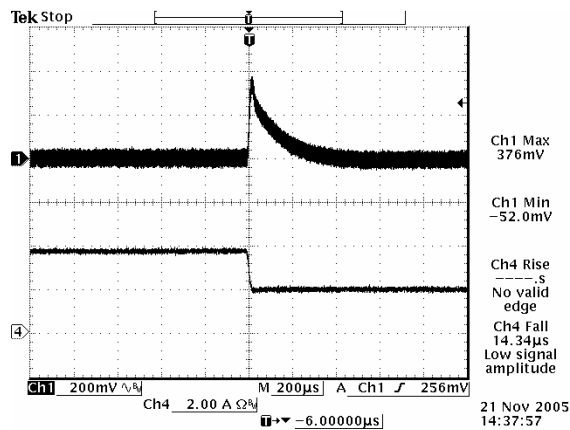

Vo=5.0 V 50% to 25% Load Transients

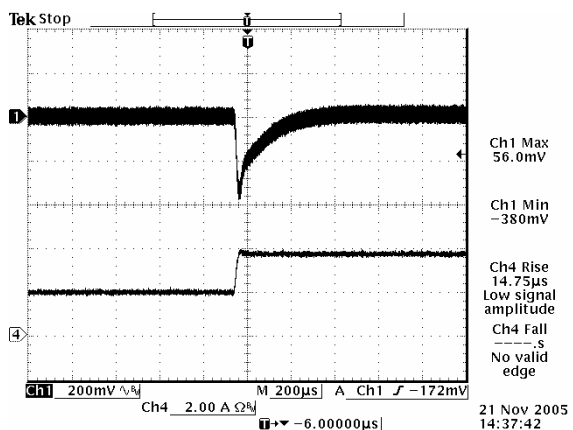

Vo=5.0 V 25% to 50% Load Transients

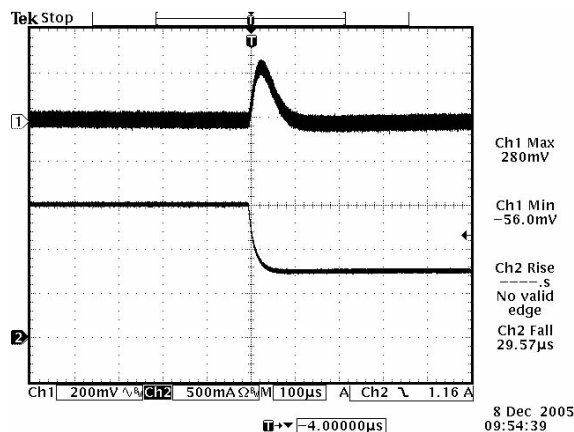

Vo=12 V 50% to 25% Load Transients

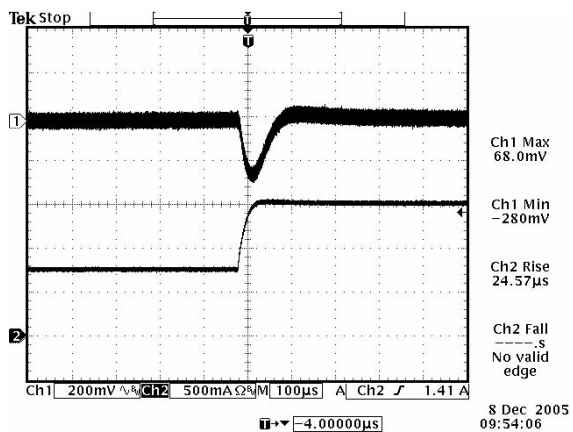

Vo=12 V 25% to 50% Load Transients

**Note:** Transient Response at Vin=48 V, di/dt=0.1A/uS, with external 220 uF tantalum capacitor and 1 uF ceramic capacitor, and Ta=25 deg C.

# ISOLATED DC/DC CONVERTERS

48 Vdc Input, 1.2 Vdc - 12 Vdc / 15 A - 3 A Outputs, 1/16 Brick Converter



## Mechanical Outline

### SMT Package

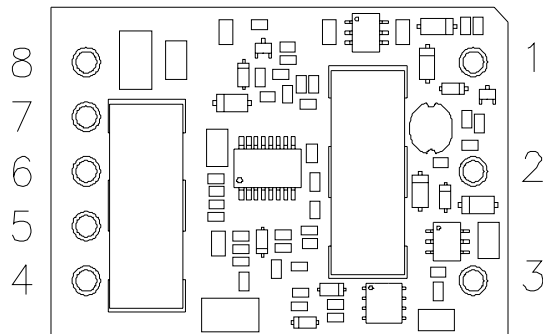
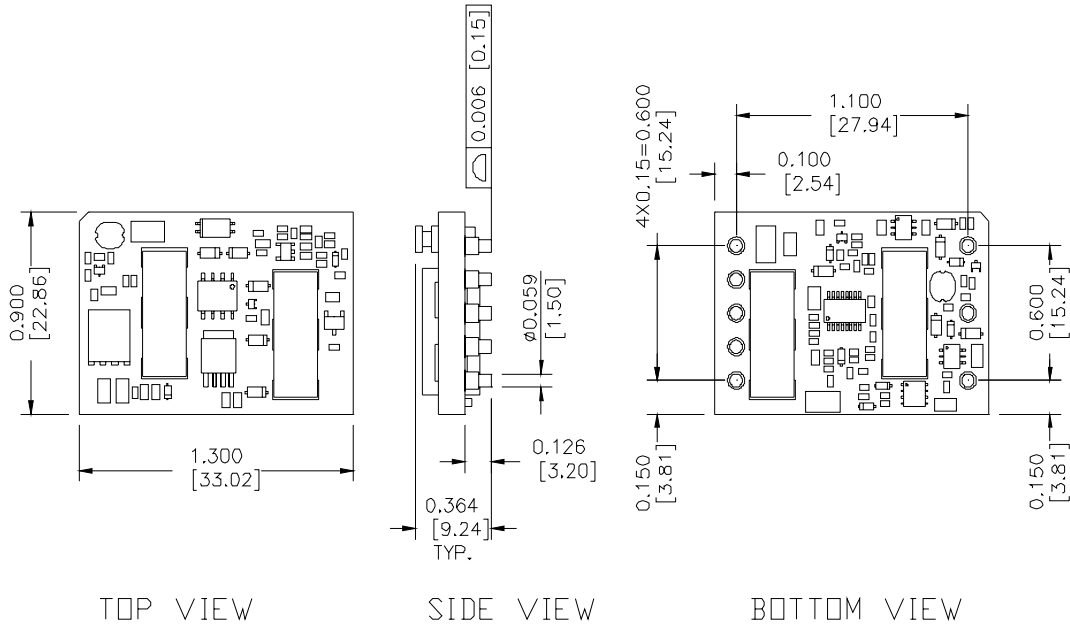

### RECOMMENDED PCB PAD LAYOUT

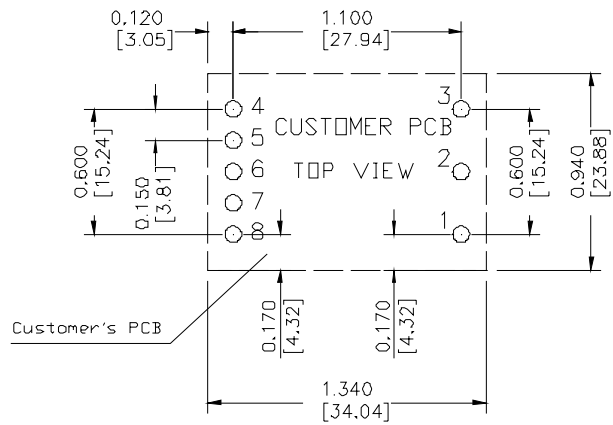

### Pin Connections

Pin	Function
1	Vin (+)
2	Remote On/Off
3	Vin (-)
4	Vout-
5	Remote Sense (-)
6	Trim
7	Remote Sense (+)
8	Vout (+)

Recommended Surface Mount Pads  
 Min.  $\phi 0.080$ " [2.03]  
 Max.  $\phi 0.092$ " [2.34]

# ISOLATED DC/DC CONVERTERS

48 Vdc Input, 1.2 Vdc - 12 Vdc / 15 A - 3 A Outputs, 1/16 Brick Converter



## Mechanical Outline (continued) Through Hole Package

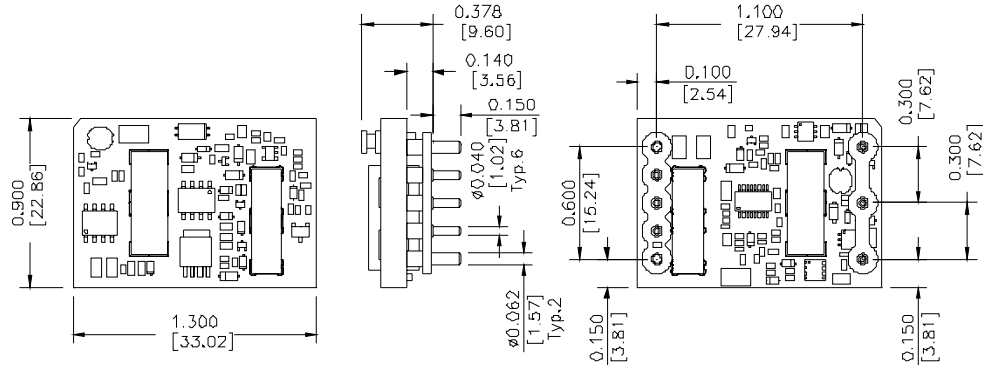

TOP VIEW

SIDE VIEW

BOTTOM VIEW

UNIT: INCH [mm]

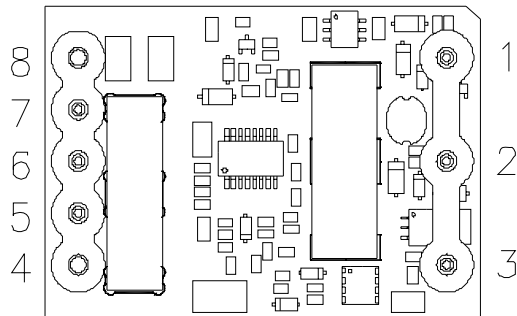

### RECOMMENDED PCB PAD LAYOUT

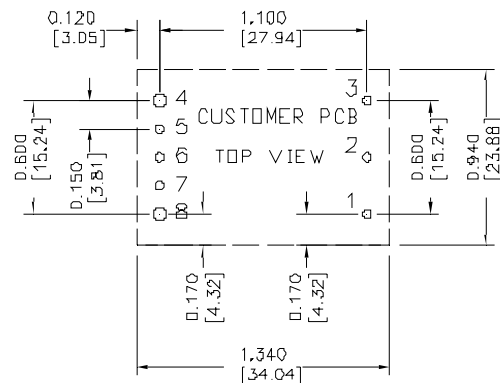

HOLE SIZE: 1-3, 5-7  $\phi$ 0.047 [1.19],  
 4,8  $\phi$ 0.07 [1.78]  
 PAD SIZE: 1-3, 5-7  $\phi$ 0.08 [2.03]  
 4,8  $\phi$ 0.10 [2.54]

### Pin Connections

Pin	Function
1	Vin (+)
2	Remote On/Off
3	Vin (-)
4	Vout-
5	Remote Sense (-)
6	Trim
7	Remote Sense (+)
8	Vout (+)

### RoHS Compliance

Complies with the European Directive 2002/95/EC, calling for the elimination of lead and other hazardous substances from electronic products.



©2008 Bel Fuse Inc. Specifications subject to change without notice. 022708

#### CORPORATE

Bel Fuse Inc.  
 206 Van Vorst Street  
 Jersey City, NJ 07302  
 Tel 201-432-0463  
 Fax 201-432-9542  
[www.belfuse.com](http://www.belfuse.com)

#### FAR EAST

Bel Fuse Ltd.  
 8F/ 8 Luk Hop Street  
 San Po Kong  
 Kowloon, Hong Kong  
 Tel 852-2328-5515  
 Fax 852-2352-3706  
[www.belfuse.com](http://www.belfuse.com)

#### EUROPE

Bel Fuse Europe Ltd.  
 Preston Technology Management Centre  
 Marsh Lane, Suite G7, Preston  
 Lancashire, PR1 8UD, U.K.  
 Tel 44-1772-556601  
 Fax 44-1772-888366  
[www.belfuse.com](http://www.belfuse.com)