

## GSIB480-E

### SINGLE PHASE GLASS PASSIVATED BRIDGE RECTIFIER

Voltage: 800V

Current: 4.0A



#### Features

Glass passivated chip junction  
Ideal for printed circuit board  
High surge current capability  
High case dielectric strength  
Halogen Free

#### Mechanical Data

Terminal: Plated leads solderable per MIL-STD 202E,  
Method 208C  
Case: UL-94 Class V-0 recognized Halogen Free Epoxy  
Polarity: Polarity symbol marked on body  
Mounting position: any

#### GSIB-3S

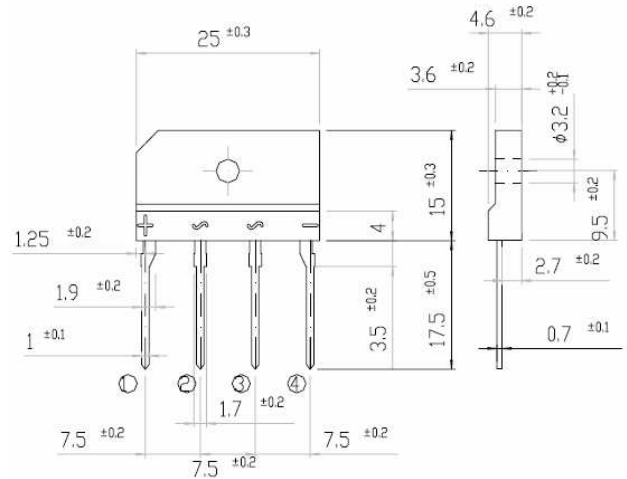

Dimensions in millimeters

### MAXIMUM RATINGS AND ELECTRICAL CHARACTERISTICS

(single-phase, half -wave, 60HZ, resistive or inductive load rating at 25°C, unless otherwise stated,  
for capacitive load, derate current by 20%)

	Symbol	GSIB480-E	units
Maximum repetitive peak reverse voltage	V <sub>rrm</sub>	800	V
Maximum RMS voltage	V <sub>rms</sub>	560	V
Maximum DC blocking voltage	V <sub>dc</sub>	800	V
Maximum average forward Rectified output current at T <sub>c</sub> = 100°C (Note 1) Ta = 25°C (Note 2)	I <sub>f(av)</sub>	4.0 2.3	A
Peak forward surge current single sine-wave superimposed on rated load (JEDEC Method)	I <sub>fsm</sub>	130	A
Maximum instantaneous forward voltage drop per leg at 2.0A	V <sub>f</sub>	0.95	V
Rating for fusing (t < 8.3ms)	I <sup>2</sup> t	60	A <sup>2</sup> Sec
Maximum DC reverse current at rated DC blocking voltage per leg Ta = 25°C Ta = 125°C	I <sub>r</sub>	10.0 250	μA
Maximum thermal resistance per leg (Note2) (Note1)	R <sub>th(ja)</sub> R <sub>th(jc)</sub>	26.0 5.0	°C/W
Operating junction and storage temperature range	T <sub>j</sub> , T <sub>stg</sub>	-55 to +150	°C

Note:

1. Unit case mounted on Al plate heatsink
2. Unit case mounted on P.C.B. with 0.5 x 0.5" (12 x 12mm) copper pads and 0.375" (9.5mm) lead length
3. Recommended mounting position is to bolt down on heatsink with silicone thermal compound for maximum heat transfer with #6 screw

## RATINGS AND CHARACTERISTIC CURVES GSIB480-E

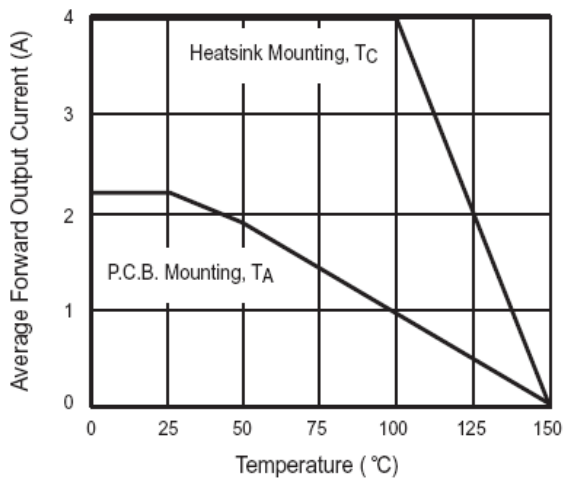

Figure 1. Derating Curve Output Rectified Current

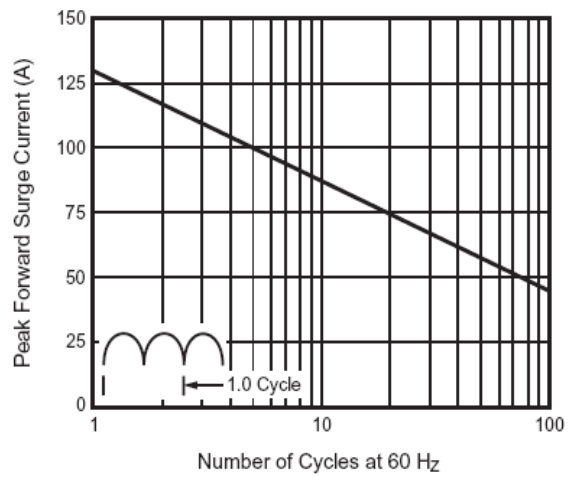

Figure 2. Maximum Non-Repetitive Peak Forward Surge Current Per Leg

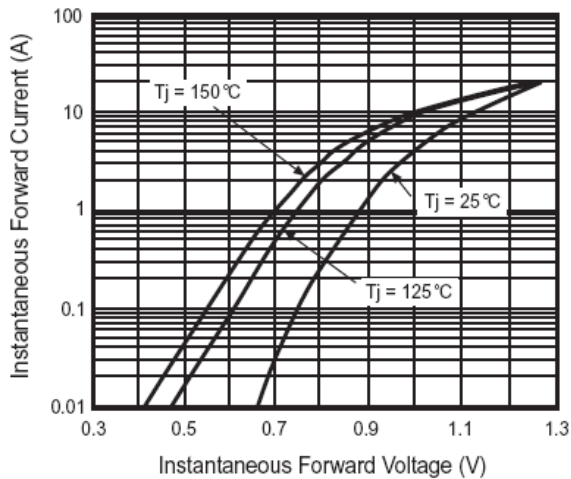

Figure 3. Typical Forward Characteristics Per Leg

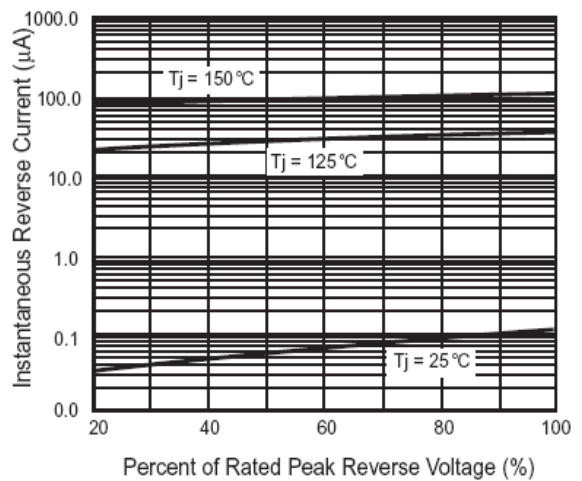

Figure 4. Typical Reverse Characteristics Per Leg

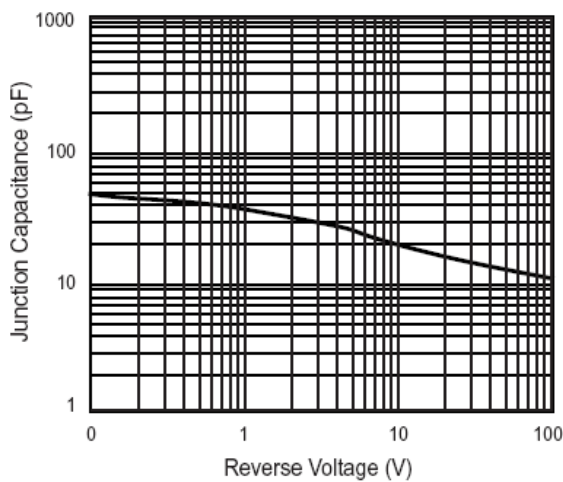

Figure 5. Typical Junction Capacitance Per Leg

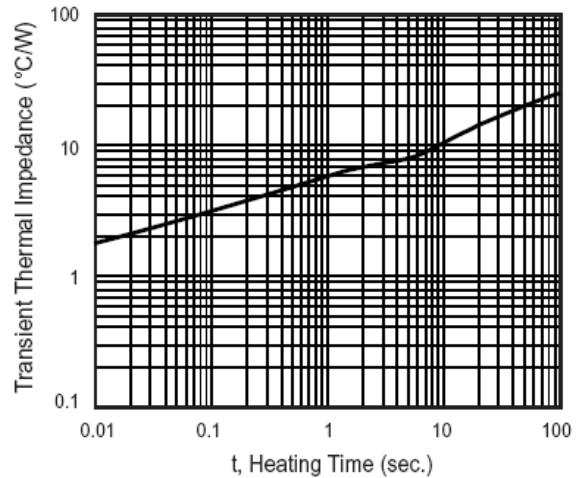

Figure 6. Typical Transient Thermal Impedance Per Leg