

KSH13009F

SemiHow
Know-How for Semiconductor

KSH13009F

Switch Mode series NPN silicon Power Transistor

- High voltage, high speed power switching
- Suitable for switching regulator, inverters motor controls

Absolute Maximum Ratings TC=25°C unless otherwise noted

12 Amperes
NPN Silicon Power Transistor
100 Watts

CHARACTERISTICS	SYMBOL	RATING	UNIT
Collector-Base Voltage	V_{CBO}	700	V
Collector-Emitter Voltage	V_{CEO}	400	V
Emitter-Base Voltage	V_{EBO}	9	V
Collector Current(DC)	I_C	12	A
Collector Current(Pulse)	I_{CP}	24	A
Base Current	I_B	6	A
Collector Dissipation(Tc=25°C)	P_C	50	W
Junction Temperature	T_J	150	°C
Storage Temperature	T_{STG}	-65~150	°C

TO-220F
1. Base
2. Collector
3. Emitter

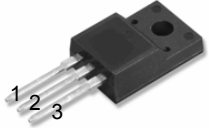

Electrical Characteristics TC=25°C unless otherwise noted

CHARACTERISTICS	SYMBOL	Test Condition	Min	Typ.	Max	Unit
Collector-Emitter Sustaining Voltage	$V_{CEO(sus)}$	$I_C=10mA, I_B=0$	400			V
Emitter Cut-off Current	I_{EBO}	$V_{EB}=9V, I_C=0$			1	mA
*DC Current Gain	h_{FE1} h_{FE2}	$V_{CE}=5V, I_C=5A$ $V_{CE}=5V, I_C=8A$	8 6		40 30	
*Collector-Emitter Saturation Voltage	$V_{CE(sat)}$	$I_C=5A, I_B=1A$ $I_C=8A, I_B=1.6A$ $I_C=12A, I_B=3A$			1 1.5 3	V V V
*Base-Emitter Saturation Voltage	$V_{BE(sat)}$	$I_C=5A, I_B=1A$ $I_C=8A, I_B=1.6A$			1.2 1.6	V V
Output Capacitance	C_{ob}	$V_{CB}=10V, f=0.1MHz$		180		pF
Current Gain Bandwidth Product	f_T	$V_{CE}=10V, I_C=0.5A$	4			MHz
Turn on Time	t_{on}	$V_{CC}=125V, I_C=8A$ $I_{B1}=1.6A, I_{B2}=-1.6A$ $R_L=15.6\Omega$			1.1	μs
Storage Time	t_{stg}				3	μs
Fall Time	t_F				0.7	μs

* Pulse Test: Pulse Width≤300μs, Duty Cycle≤2%

Note.

hFE1 Classification	R	8 ~ 17
	O	15~28
	Y	26 ~ 39
	Y1(26~33), Y2(31~39)	

Package Mark information.

S YWW Z KSH13009F	S	SemiHow Symbol
	YWW	Y; year code, WW; week code
	Z	hFE1 Classification

Typical Characteristics

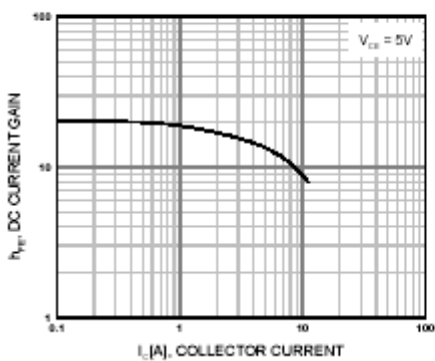

Figure 1. DC current Gain

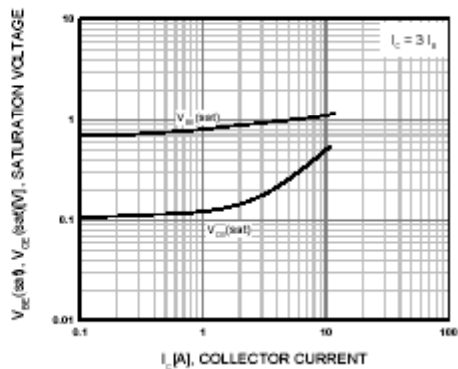

Figure 2. Base-Emitter Saturation Voltage
Collector-Emitter Saturation Voltage

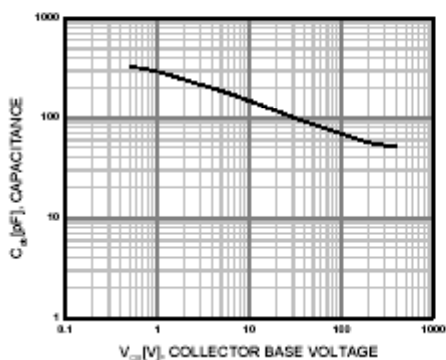

Figure 3. Collector Output Capacitance

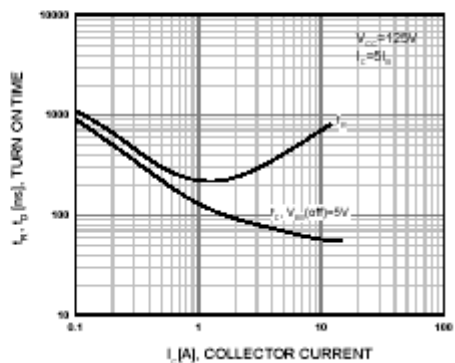

Figure 4. Turn On Time

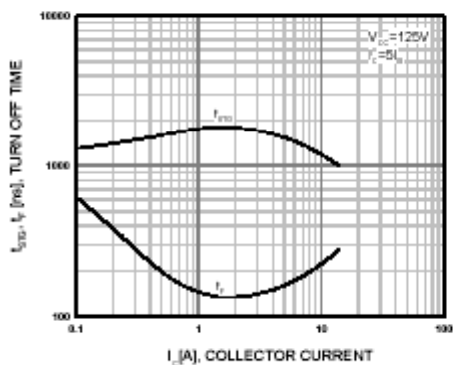

Figure 5. Turn Off Time

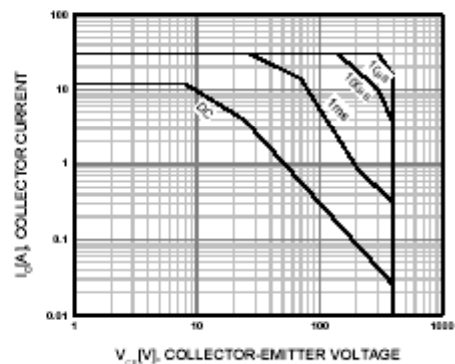

Figure 6. Forward Bias Safe Operating Area

Typical Characteristics (Continued)

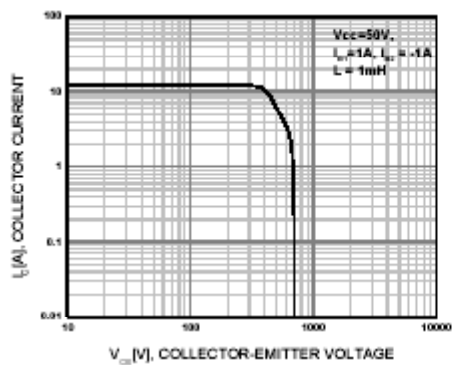

Figure 7. Reverse Bias Safe Operating Area

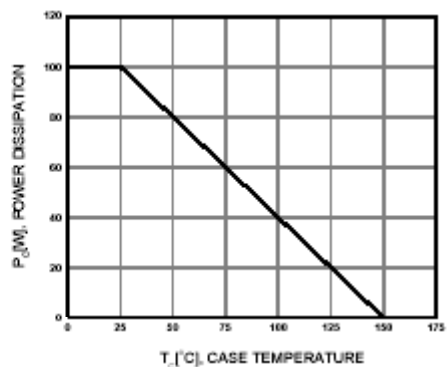
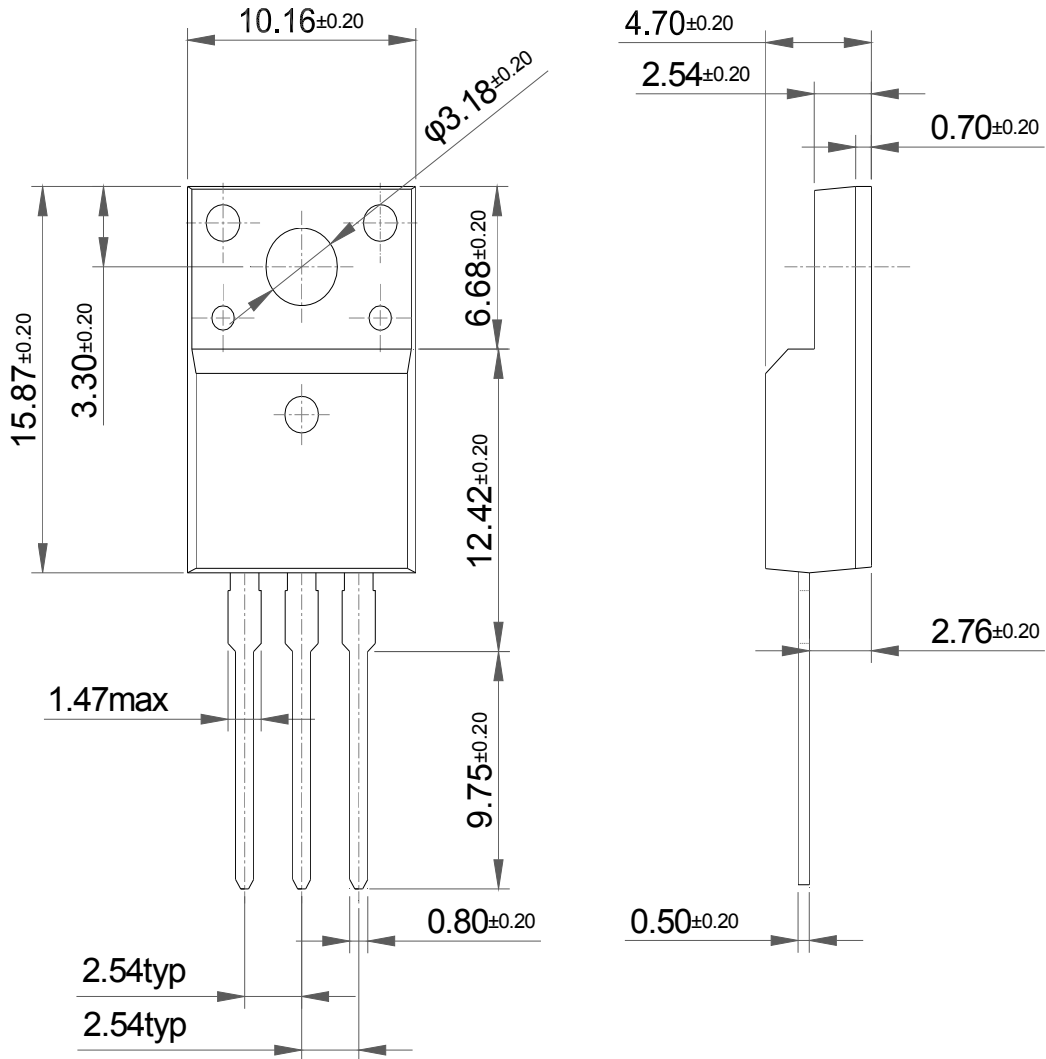

Figure 8. Power Derating

Package Dimension

TO-220F



Dimensions in Millimeters