

### Typical Applications

The HMC569LC5 is ideal for:

- Point-to-Point and Point-to-Multi-Point Radio
- Military Radar, EW & ELINT
- Satellite Communications

### Features

- Conversion Gain: 14 dB
- Image Rejection: 32 dB
- LO to RF Isolation: 45 dB
- Noise Figure: 2.5 dB
- Input IP3: -0.5 dBm
- RoHS Compliant 5x5 mm SMT Package

### Functional Diagram

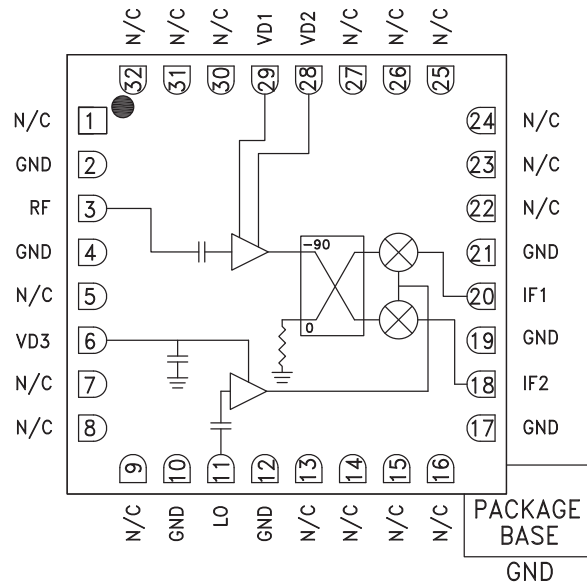

### General Description

The HMC569LC5 is a compact GaAs MCM I/Q downconverter in a leadless RoHS compliant SMT package. This device provides a small signal conversion gain of 14 dB with a noise figure of 2.5 dB and 32 dB of image rejection. The HMC569LC5 utilizes an LNA followed by an image reject mixer which is driven by an LO buffer amplifier. The image reject mixer eliminates the need for a filter following the LNA, and removes thermal noise at the image frequency. I and Q mixer outputs are provided and an external 90° hybrid is needed to select the required sideband. The HMC569LC5 is a much smaller alternative to hybrid style image reject mixer downconverter assemblies, and it eliminates the need for wire bonding by allowing the use of surface mount manufacturing techniques.

### Electrical Specifications, $T_A = +25^\circ C$ , $IF = 100 MHz$ , $LO = 0 dBm$ , $VD3 = 5V$ , $VD1, VD2 = 3V^*$

Parameter	Min.	Typ.	Max.	Units
Frequency Range, RF		12 - 16		GHz
Frequency Range, LO		8.5 - 19.5		GHz
Frequency Range, IF		DC - 3.5		GHz
Conversion Gain (As IRM)	10	14		dB
Noise Figure		2.5		dB
Image Rejection	15	32		dB
1 dB Compression (Input)		-7		dBm
LO to RF Isolation	30	45		dB
LO to IF Isolation	20	32		dB
IP3 (Input)		-0.5		dBm
Amplitude Balance		0		dB
Phase Balance		±10		Deg
Total Supply Current		160	208	mA

\*Data taken as IRM with external IF Hybrid

Data Taken As IRM With External IF Hybrid

**Conversion Gain vs. Temperature**

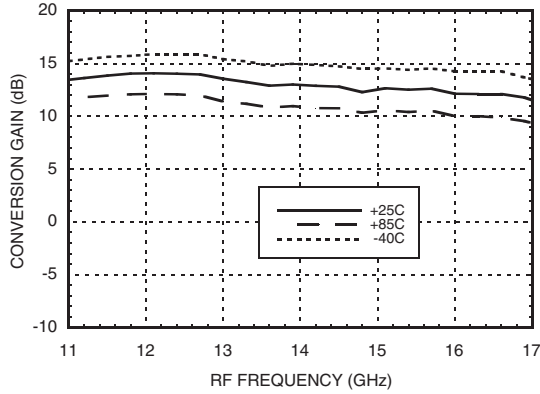

**Image Rejection vs. Temperature**

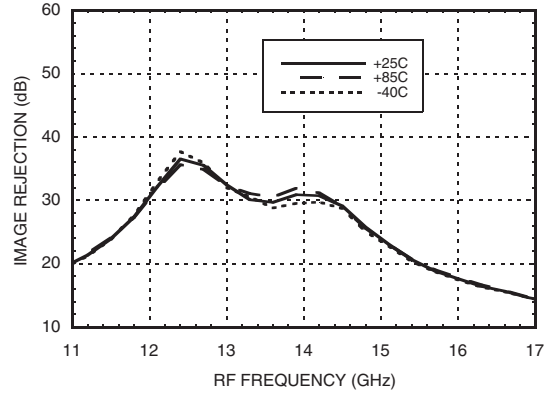

**Conversion Gain vs. LO Drive**

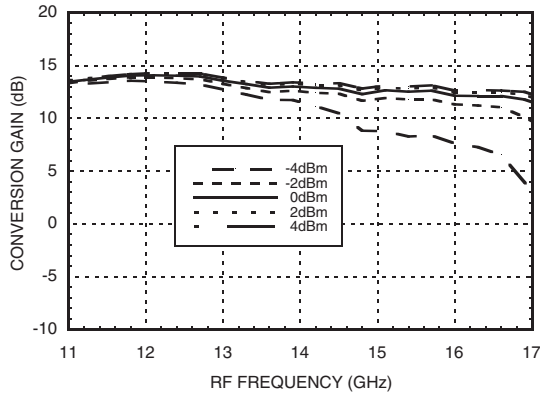

**Return Loss**

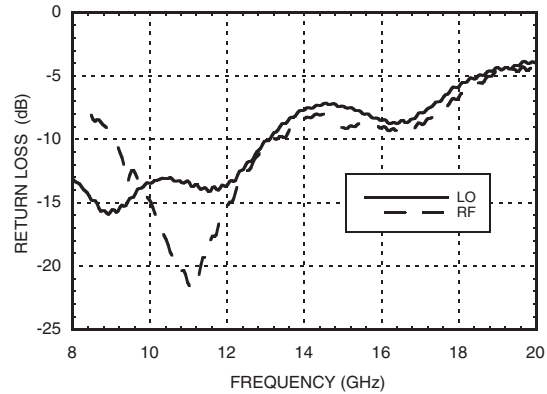

**Input P1dB vs. Temperature**

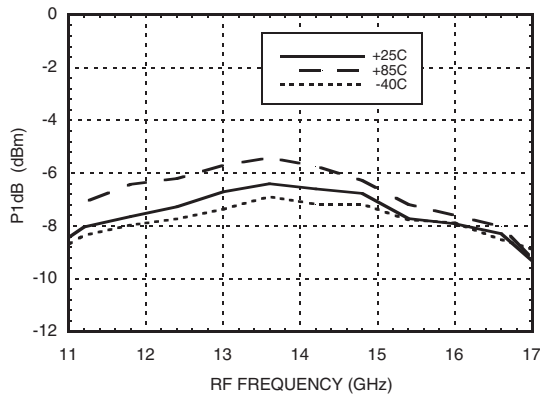

**Input IP3 vs. LO Drive**

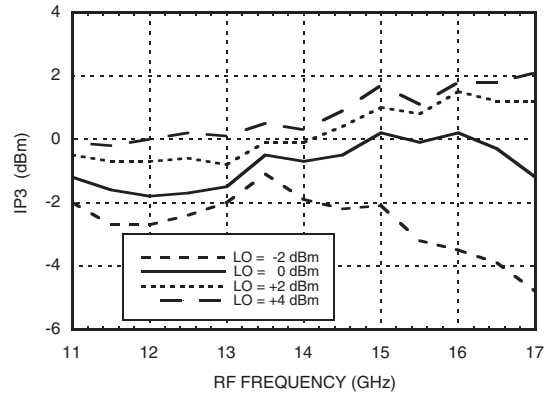



### Quadrature Channel Data Taken Without IF Hybrid

#### Isolations

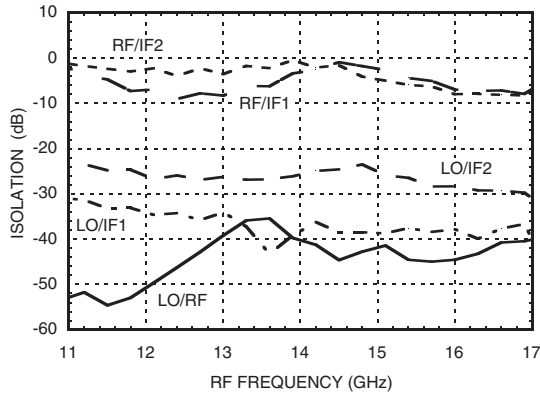

#### IF Bandwidth\*

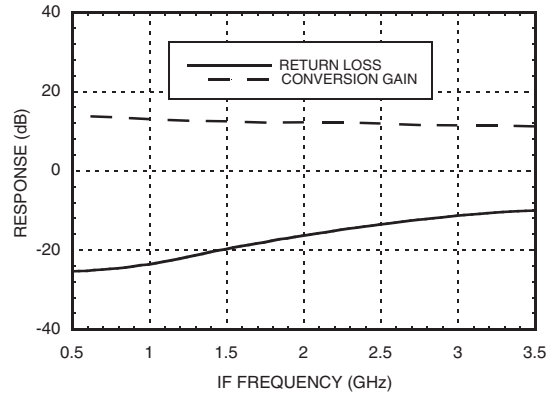

#### Amplitude Balance vs. LO Drive

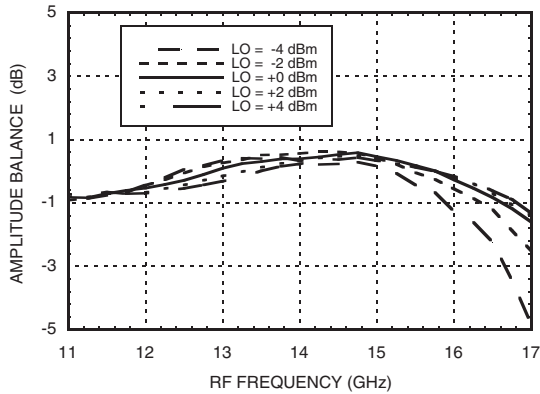

#### Phase Balance vs. LO Drive

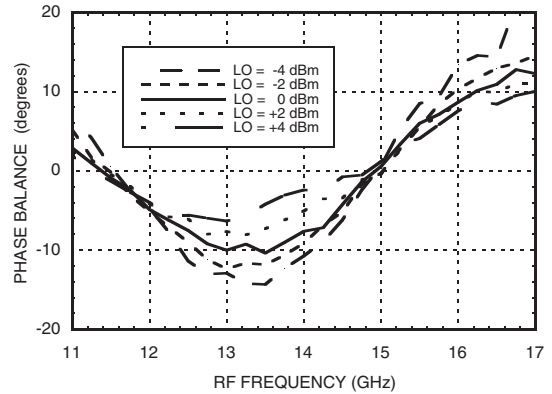

#### Noise Figure vs. LO Drive, LO Frequency = 12 GHz

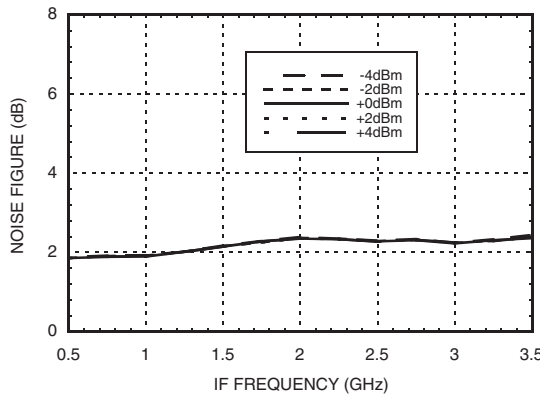

#### Noise Figure vs. LO Drive, IF Frequency = 100 MHz

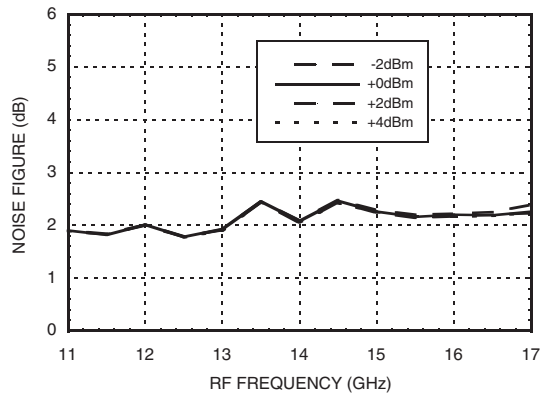

\* Conversion gain data taken with external IF hybrid, LO frequency fixed at 12 GHz and RF varied

### MxN Spurious Outputs

mRF	nLO				
	0	1	2	3	4
0	xx	14	27	41	54
1	14	xx	13	27	40
2	27	14	xx	13	27
3	41	27	14	xx	13
4	54	41	27	14	xx

RF = 13.6 GHz @ -20 dBm  
LO = 13.5 GHz @ 0 dBm  
Data taken without IF hybrid  
All values in dBc below IF power level.

### Absolute Maximum Ratings

RF	+5 dBm
LO Drive	+20 dBm
VD1, VD2	4.0V
VD3	5.5V
Channel Temperature	150°C
Continuous Pdiss (T=85°C) (derate 9.56 mW/°C above 85°C)	0.65 W
Thermal Resistance (R <sub>TH</sub> ) (channel to package bottom)	71 °C/W
Storage Temperature	-65 to +150 °C
Operating Temperature	-55 to +85 °C
ESD Sensitivity (HBM)	Class 1A



ELECTROSTATIC SENSITIVE DEVICE  
OBSERVE HANDLING PRECAUTIONS

### Outline Drawing

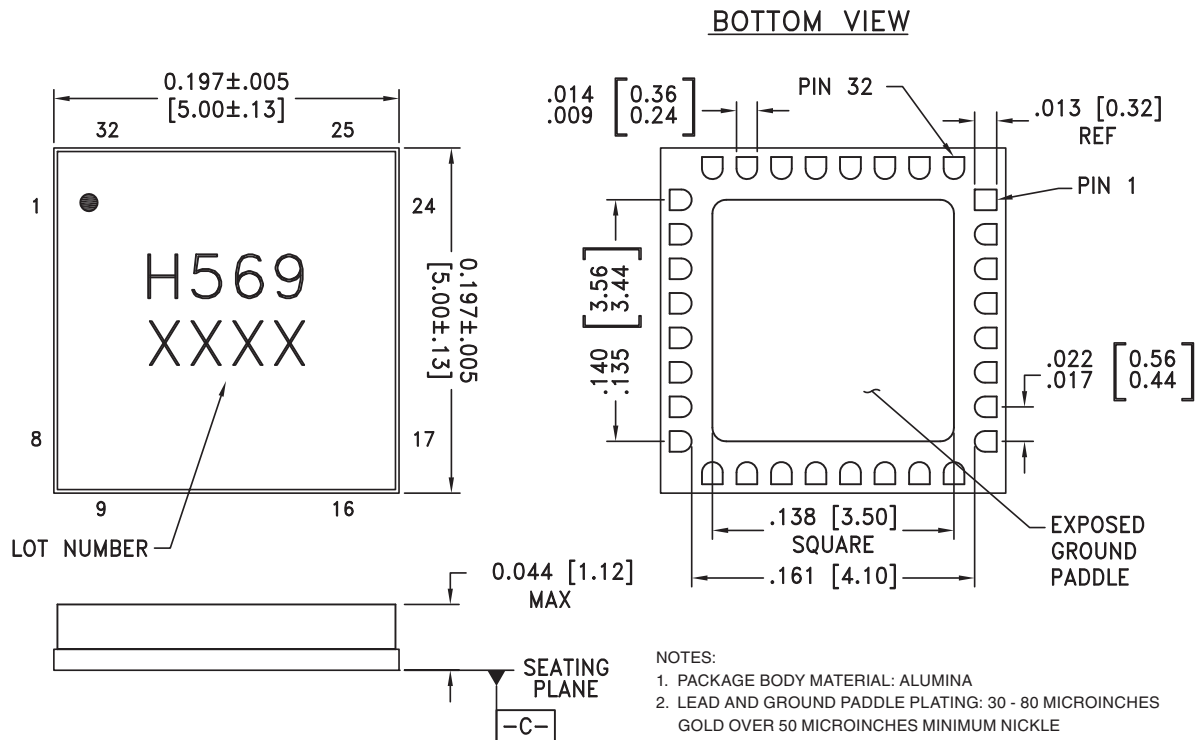

- NOTES:
1. PACKAGE BODY MATERIAL: ALUMINA
  2. LEAD AND GROUND PADDLE PLATING: 30 - 80 MICROINCHES GOLD OVER 50 MICROINCHES MINIMUM NICKLE
  3. DIMENSIONS ARE IN INCHES [MILLIMETERS]
  4. LEAD SPACING TOLERANCE IS NON-CUMULATIVE
  5. PACKAGE WARP SHALL NOT EXCEED 0.05mm DATUM
  6. ALL GROUND LEADS AND GROUND PADDLE MUST BE SOLDERED TO PCB RF GROUND

### Pin Descriptions

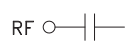
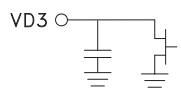
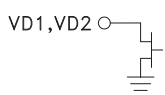
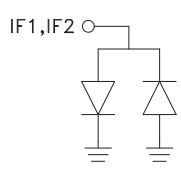
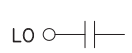
Pin Number	Function	Description	Interface Schematic
1, 5, 7 - 9, 13 - 16, 22 - 27, 30 - 32	N/C	No connection required. These pins may be connected to RF/DC ground without affecting performance.	
2, 4, 10, 12, 17, 19, 21	GND	These pins and ground paddle must be connected to RF/DC ground.	
3	RF	This pin is AC coupled and matched to 50 Ohms.	
6	VD3	Power supply for LO amplifier. 100 mA typical, 120 mA maximum.	
28, 29	VD1, VD2	Power supply for RF LNA. 60 mA typical, 88 mA maximum.	
18	IF2	This pin is DC coupled for applications not requiring operation to DC. This port should be DC blocked externally using a series capacitor whose value has been chosen to pass the necessary frequency range. For operation to DC, this pin must not sink / source more than 3 mA of current or part non-function and possible failure will result.	
20	IF1		
11	LO	This pin is AC coupled and matched to 50 Ohms.	

### Typical Application

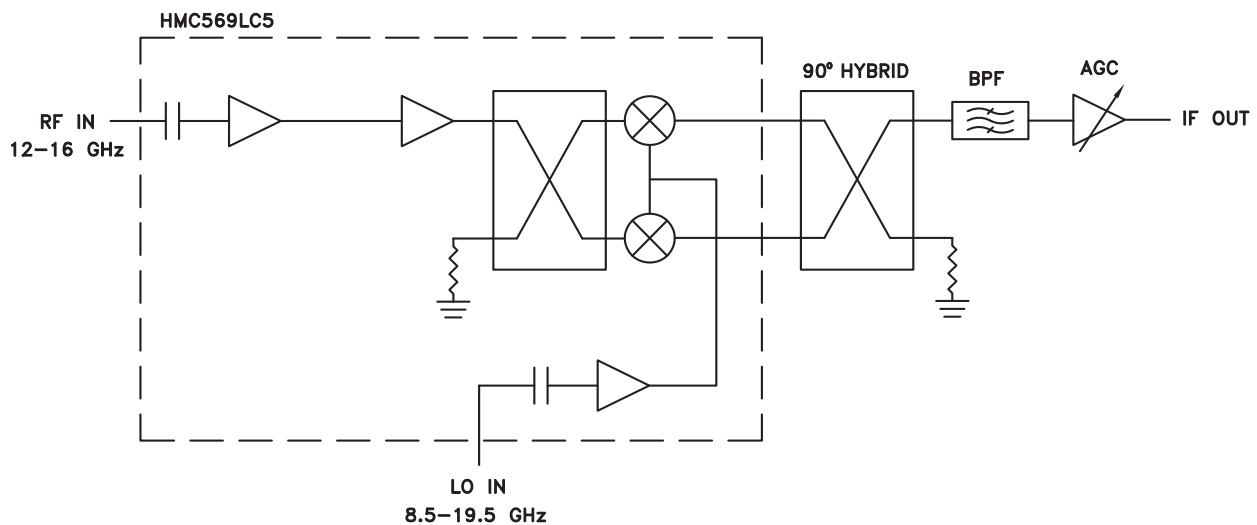

Note: LSB and USB is determined by GND on Hybrid

For price, delivery, and to place orders, please contact Hittite Microwave Corporation:  
 20 Alpha Road, Chelmsford, MA 01824 Phone: 978-250-3343 Fax: 978-250-3373  
 Order On-line at [www.hittite.com](http://www.hittite.com)

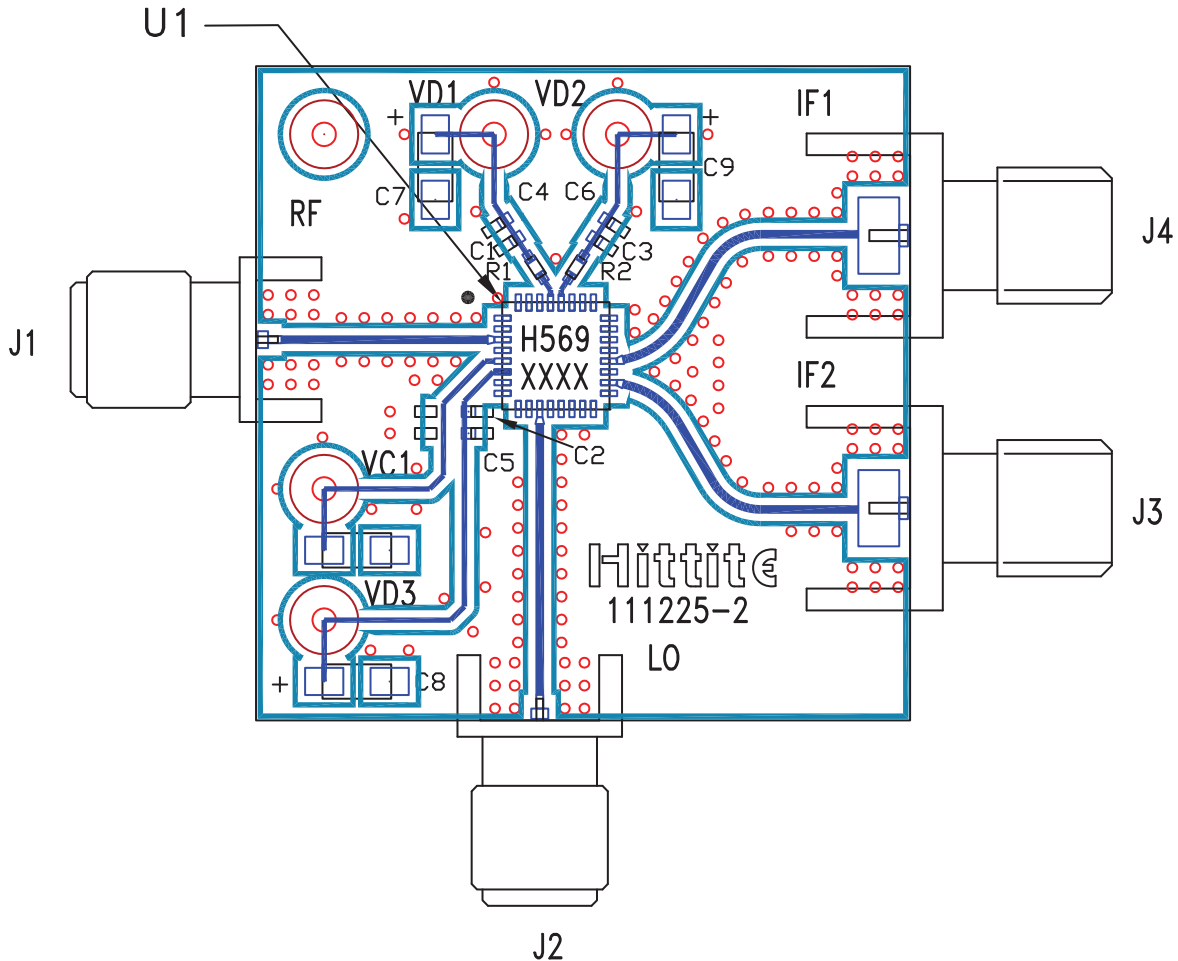
**Evaluation PCB**

**List of Materials for Evaluation PCB 111227 [1]**

Item	Description
C1, C2, C3	Capacitor 0402, Pkg. 100pF
C4, C5, C6	Capacitor 0402, Pkg. 1000pF
C7, C8, C9	Capacitor, Case A, 2.2uF *(Polarity)
J1, J2	PCB Mount SMA RF Connector, SRI
J3, J4	PCB Mount SMA Connector, Johnson
J5, J6	DC Pin
J7	DC Pin
R1, R2	Resistor, 0402 Pkg. 0 Ohm
U1	HMC569LC5
VC1	N/C
PCB [2]	111225 Evaluation Board

[1] Reference this number when ordering complete evaluation PCB

[2] Circuit Board Material: Rogers 4350

The circuit board used in the final application should use RF circuit design techniques. Signal lines should have 50 ohm impedance while the package ground leads and exposed paddle should be connected directly to the ground plane similar to that shown. A sufficient number of via holes should be used to connect the top and bottom ground planes. The evaluation circuit board shown is available from Hittite upon request.