

# SKiiP 36NAB126V1

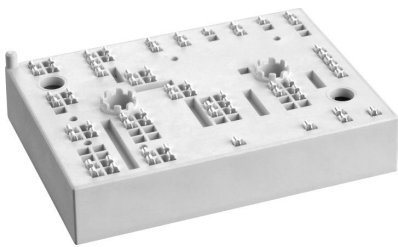

## MiniSKiiP® 3

3-phase bridge rectifier +  
brake chopper + 3-phase  
bridge inverter  
SKiiP 36NAB126V1

### Features

- Fast Trench IGBTs
- Robust and soft freewheeling diodes in CAL technology
- Highly reliable spring contacts for electrical connections
- UL recognised file no. E63532

### Typical Applications

- Inverter up to 36 kVA
- Typical motor power 18,5 kW

### Remarks

- $V_{CEsat}$ ,  $V_F$  = chip level value

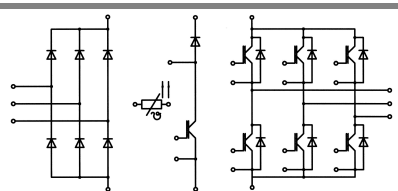

NAB

Absolute Maximum Ratings		$T_s = 25\text{ °C}$ , unless otherwise specified		
Symbol	Conditions	Values	Units	
<b>IGBT - Inverter, Chopper</b>				
$V_{CES}$	$T_s = 25\text{ (70) °C}$	1200	V	
$I_C$		88 (66)	A	
$I_{CRM}$		140	A	
$V_{GES}$		$\pm 20$	V	
$T_j$		- 40 ... + 150	°C	
<b>Diode - Inverter, Chopper</b>				
$I_F$	$T_s = 25\text{ (70) °C}$	91 (68)	A	
$I_{FRM}$		140	A	
$T_j$		- 40 ... + 150	°C	
<b>Diode - Rectifier</b>				
$V_{RRM}$	$T_s = 70\text{ °C}$	1600	V	
$I_F$		61	A	
$I_{FSM}$		$t_p = 10\text{ ms, sin } 180\text{ °}, T_j = 25\text{ °C}$	700	A
$i^2t$		$t_p = 10\text{ ms, sin } 180\text{ °}, T_j = 25\text{ °C}$	2400	A <sup>2</sup> s
$T_j$		- 40 ... + 150	°C	
<b>Module</b>				
$I_{RMS}$	per power terminal (20 A / spring)	80	A	
$T_{stg}$		- 40 ... + 125	°C	
$V_{isol}$	AC, 1 min.	2500	V	

Characteristics		$T_s = 25\text{ °C}$ , unless otherwise specified			
Symbol	Conditions	min.	typ.	max.	Units
<b>IGBT - Inverter, Chopper</b>					
$V_{CEsat}$	$I_{Cnom} = 70\text{ A}, T_j = 25\text{ (125) °C}$		1,7 (2)	2,1 (2,4)	V
$V_{GE(th)}$	$V_{GE} = V_{CE}, I_C = 3\text{ mA}$	5	5,8	6,5	V
$V_{CE(TO)}$	$T_j = 25\text{ (125) °C}$		1 (0,9)	1,2 (1,1)	V
$r_T$	$T_j = 25\text{ (125) °C}$		10 (16)	13 (19)	mΩ
$C_{ies}$	$V_{CE} = 25\text{ V}, V_{GE} = 0\text{ V}, f = 1\text{ MHz}$		4,8		nF
$C_{oes}$	$V_{CE} = 25\text{ V}, V_{GE} = 0\text{ V}, f = 1\text{ MHz}$		1		nF
$C_{res}$	$V_{CE} = 25\text{ V}, V_{GE} = 0\text{ V}, f = 1\text{ MHz}$		0,6		nF
$R_{th(j-s)}$	per IGBT		0,5		K/W
$t_{d(on)}$	under following conditions		80		ns
$t_r$	$V_{CC} = 600\text{ V}, V_{GE} = \pm 15\text{ V}$		25		ns
$t_{d(off)}$	$I_{Cnom} = 70\text{ A}, T_j = 125\text{ °C}$		390		ns
$t_f$	$R_{Gon} = R_{Goff} = 9\text{ Ω}$		90		ns
$E_{on}$	inductive load		9		mJ
$E_{off}$			7,7		mJ
<b>Diode - Inverter, Chopper</b>					
$V_F = V_{EC}$	$I_{Fnom} = 70\text{ A}, T_j = 25\text{ (125) °C}$		1,5 (1,5)	1,7 (1,7)	V
$V_{(TO)}$	$T_j = 25\text{ (125) °C}$		1 (0,8)	1,1 (0,9)	V
$r_T$	$T_j = 25\text{ (125) °C}$		7,1 (10)	8,6 (11)	mΩ
$R_{th(j-s)}$	per diode		0,7		K/W
$I_{RRM}$	under following conditions		77		A
$Q_{rr}$	$I_{Fnom} = 70\text{ A}, V_R = 600\text{ V}$		18		μC
$E_{rr}$	$V_{GE} = 0\text{ V}, T_j = 125\text{ °C}$		7,5		mJ
	$di_F/dt = 2000\text{ A/μs}$				
<b>Diode - Rectifier</b>					
$V_F$	$I_{Fnom} = 35\text{ A}, T_j = 25\text{ °C}$		1,1		V
$V_{(TO)}$	$T_j = 150\text{ °C}$		0,8		V
$r_T$	$T_j = 150\text{ °C}$		11		mΩ
$R_{th(j-s)}$	per diode		0,9		K/W
<b>Temperature Sensor</b>					
$R_{ts}$	3 %, $T_r = 25\text{ (100) °C}$		1000(1670)		Ω
<b>Mechanical Data</b>					
w			95		g
$M_s$	Mounting torque	2		2,5	Nm

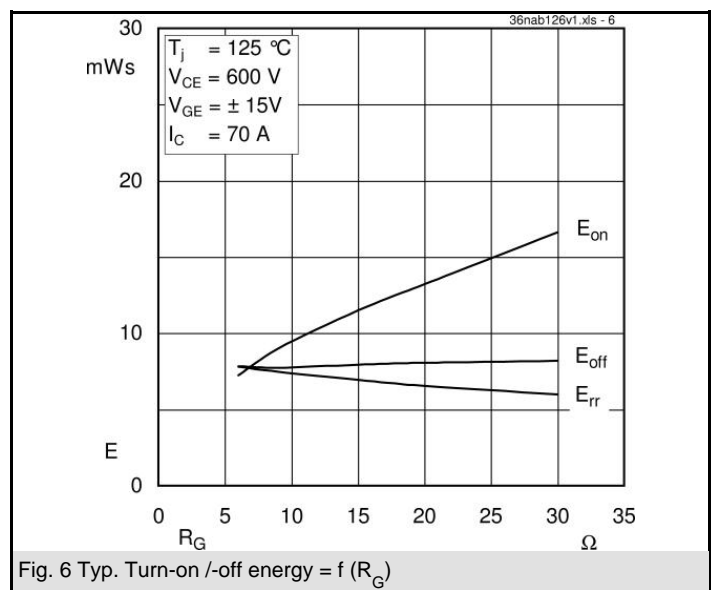
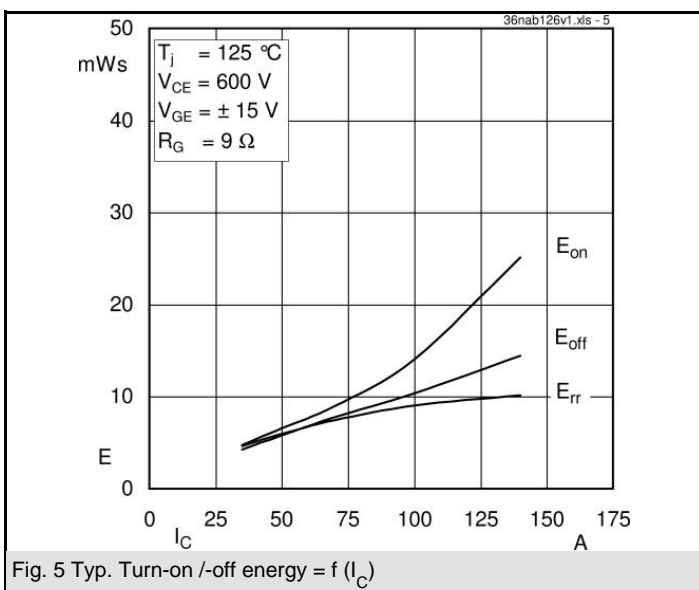
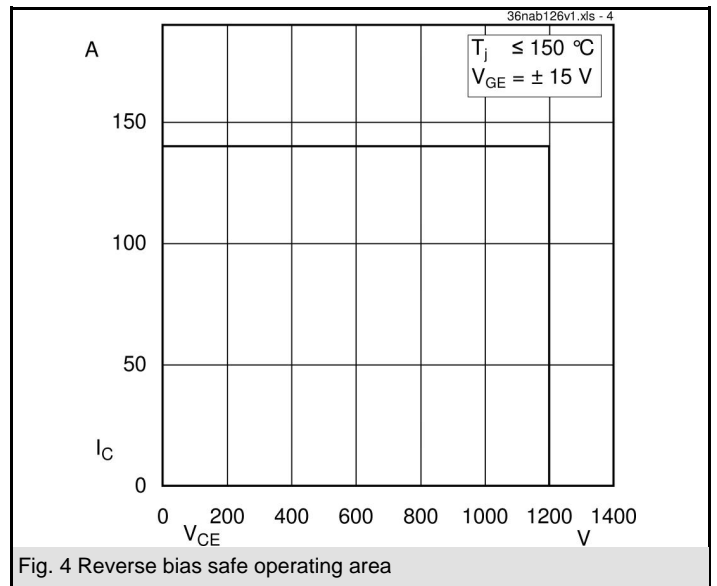
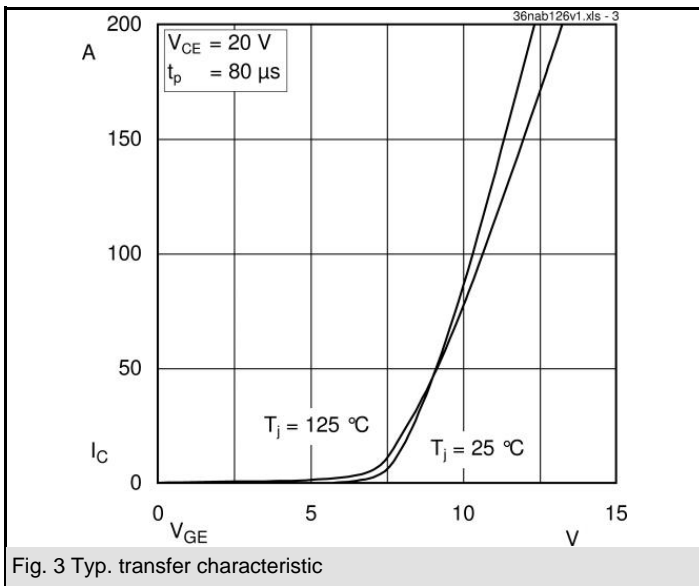
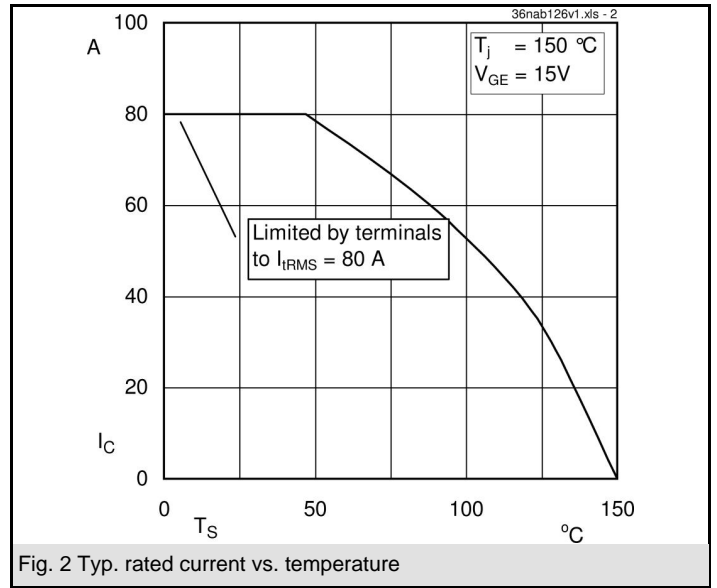
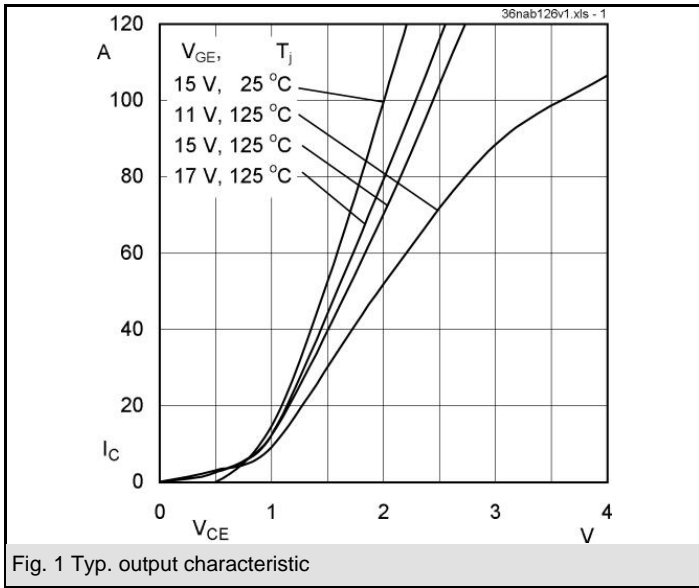

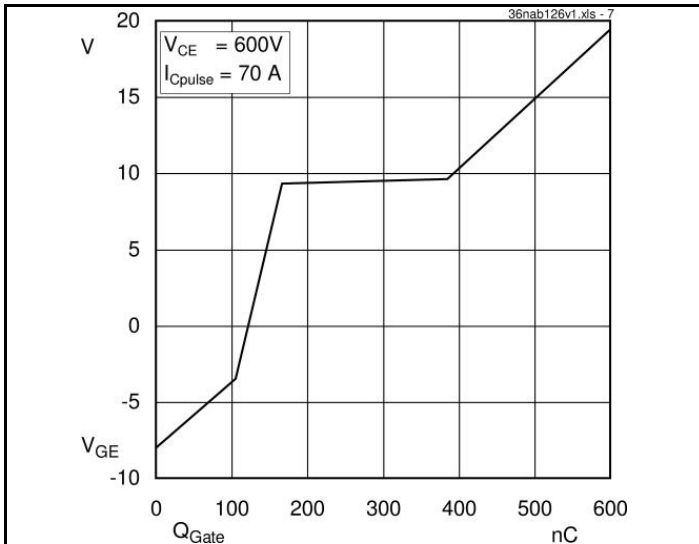

Fig. 7 Typ. gate charge characteristic

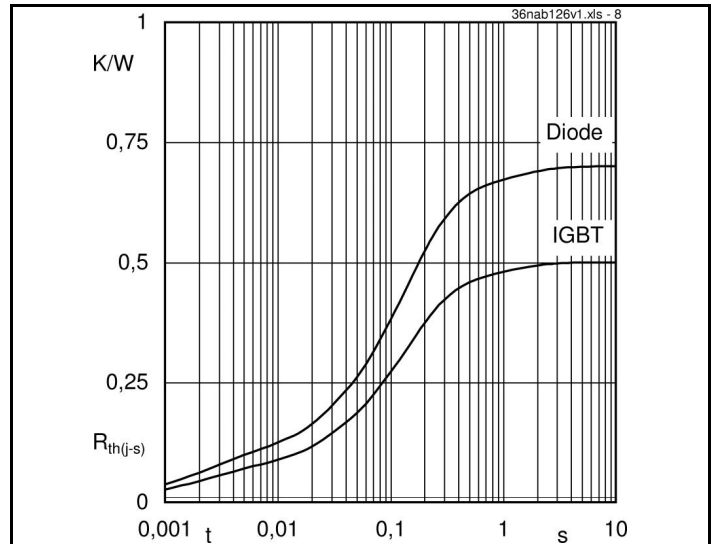

Fig. 8 Typ. thermal impedance

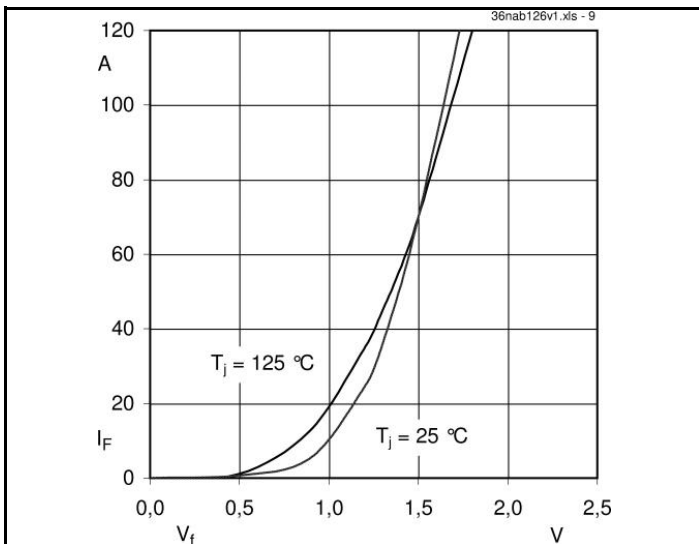

Fig. 9 Typ. freewheeling diode forward characteristic

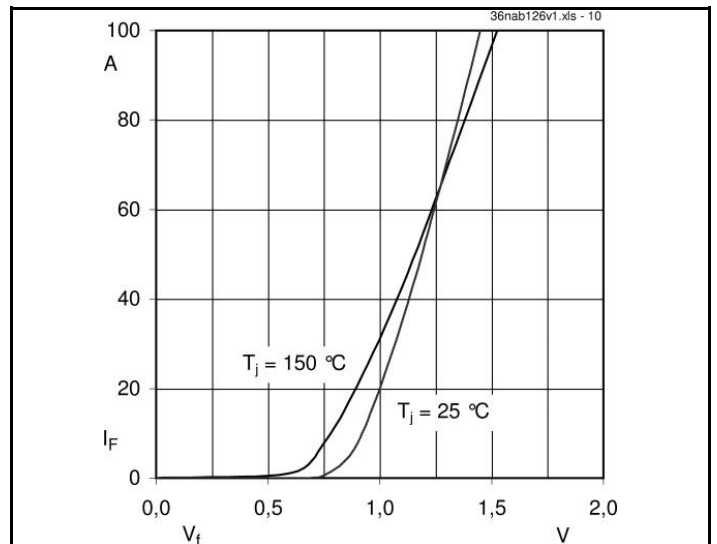
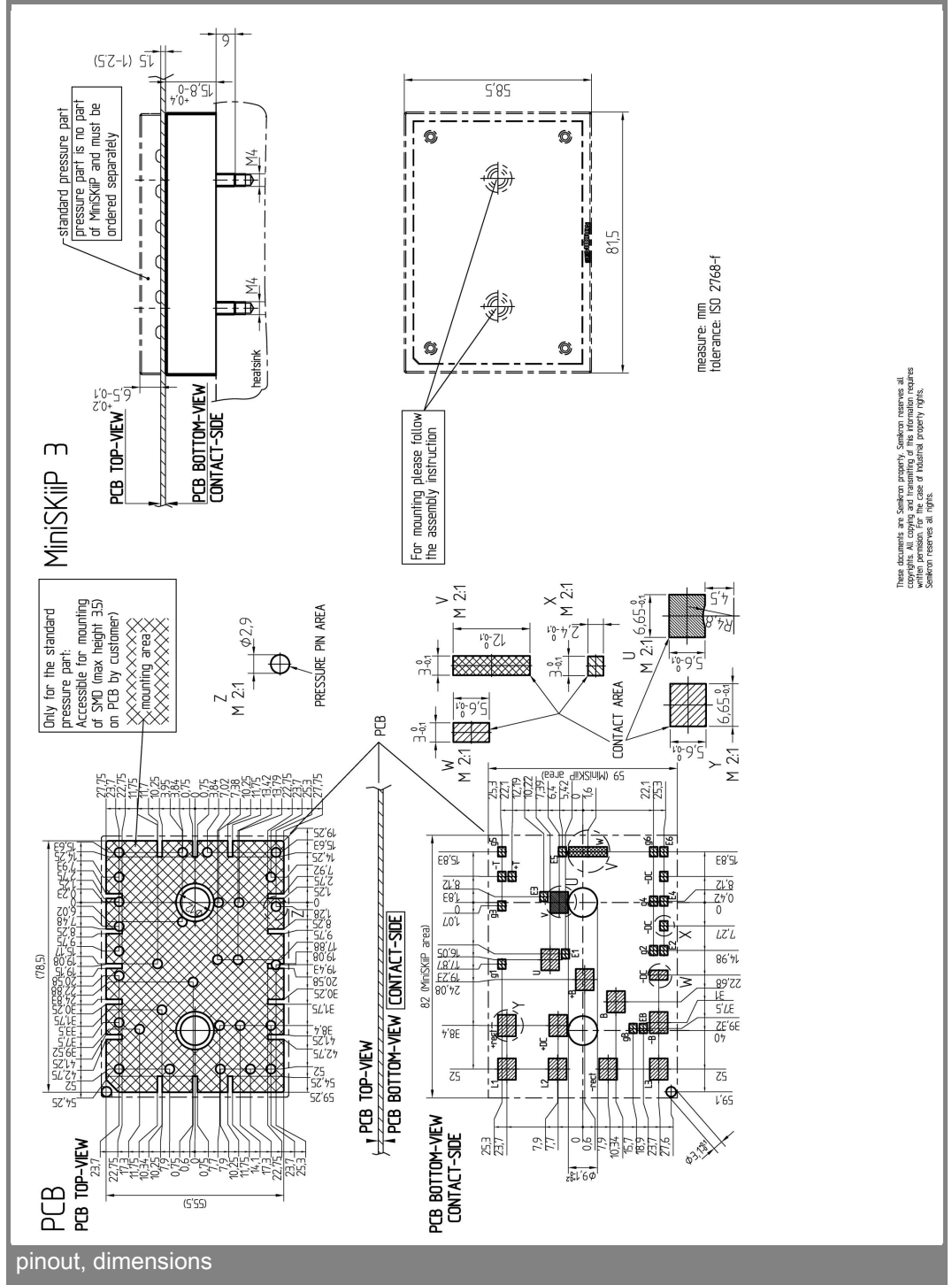
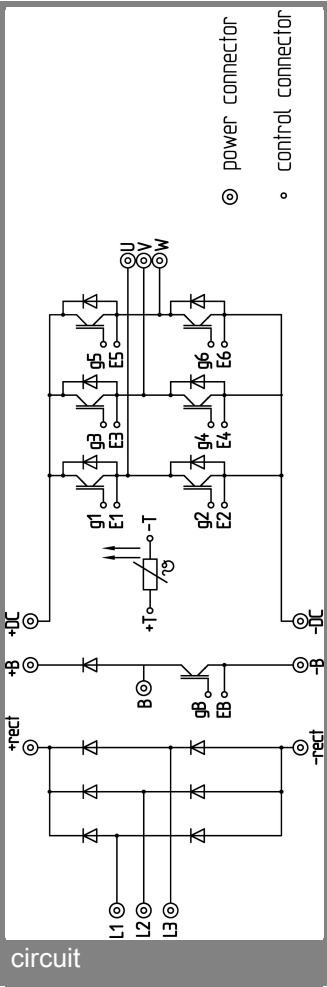

Fig. 10 Typ. input bridge forward characteristic



These documents are Semikron property. Semikron reserves all  
copyrights. All copying and releasing of this information requires  
written permission. In the case of industrial property rights,  
Semikron reserves all rights.