

0603<1.6×0.8 t=0.55mm> High Brightness Type

SML-51□ Series

Emitting Color	Green(Yellowish Green)	Yellow		Orange			Red			
Material	AlGaInP on GaAs									
Package Size(mm)										
1608(0603) 1.6×0.8(t=0.55)	New									
Part No.	SML-512PW(A)	SML-512MW	SML-511WW	SML-512WW	SML-511DW	SML-512DW	SML-512CW(A)	SML-511UW	SML-512UW	SML-512VW(A)

Absolute Maximum Ratings (Ta=25°C)

Part No.	Emitting color	Power dissipation P _d (mW)	Forward current I _F (mA)	Peak forward current I _{Fp} (mA)	Reverse voltage V _R (V)	Operating temperature T _{opr} (°C)	Storage temperature T _{stg} (°C)
SML-512MW	Green (Yellowish Green)	65	25	100*2	5	-30 to +85	-40 to +85
SML-511WW	Yellow	62	30	60*1	4	-30 to +85	-40 to +85
SML-512WW		75	30	100*2	5	-40 to +100	-40 to +100
SML-511DW	Orange	62	25	60*1	4	-30 to +85	-40 to +85
SML-512DW		75	30	100*2	5	-40 to +100	-40 to +100
SML-512CW(A)	Red	62	25	60*1	4	-30 to +85	-40 to +85
SML-511UW		75	30	100*2	5	-40 to +100	-40 to +100
SML-512UW		62	25	60*1	4	-30 to +85	-40 to +85
SML-512VW(A)	Green (Yellowish Green)	65	25	100*2	5	-40 to +100	-40 to +100

*1:Duty ≤ 1/5, pulse width ≤ 1ms.
*2:Duty 1/10, 1kHz

Dimensions (Unit:mm)

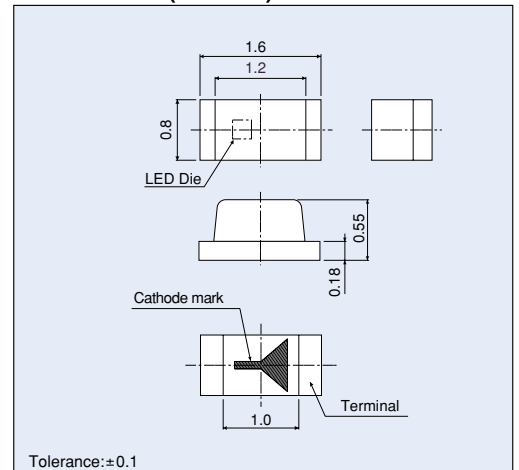

Electrical Optical Characteristics (Ta=25°C)

Part No.	Resin Color	Forward voltage V _F		Reverse current I _R		Light wavelength		Brightness I _v		
		Typ. (V)	I _F (mA)	Max. (μA)	V _R (V)	Peak λ _p (nm)	Half-wave Δλ (nm)	Min. (mcd)	Typ. (mcd)	I _F (mA)
SML-512MW	Milky White	2.1	20	100	5	570	18	14	40	20
SML-511WW		100		4	590	15	22	63		
SML-512WW		10		5	14	40				
SML-511DW		100		4	36	100				
SML-512DW		10		5	71	112				
SML-512CW(A)		100		4	14	40				
SML-511UW		10		5	22	63				
SML-512UW		100		4	35.5	56				
SML-512VW(A)		10		5	5.6	14				
SML-512PW(A)		2.1		100	5	563	15	5.6	14	

Directivity (Typ.)

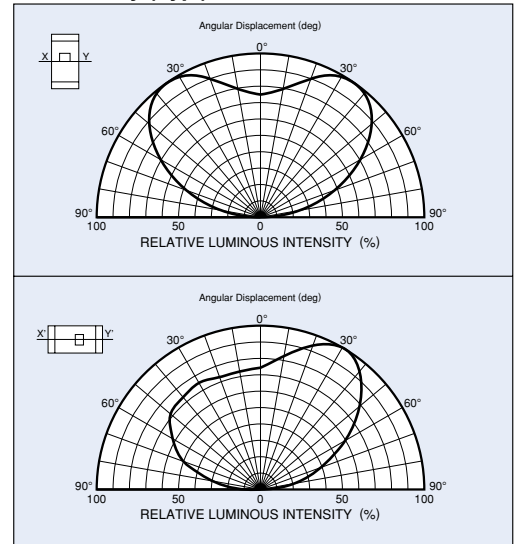

Recommended Pad Layout

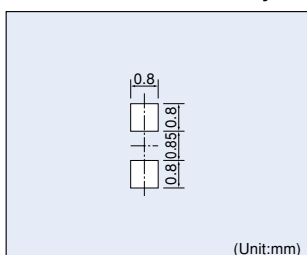

The recommended thickness of the screen mask for soldering is between 100 and 150μm. The hole size of the screen mask should be the same as the recommended land pattern or smaller.

Packaging Specifications (Unit : mm)

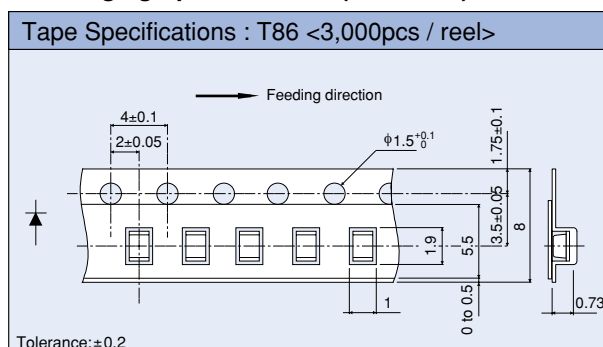

Reel Specifications

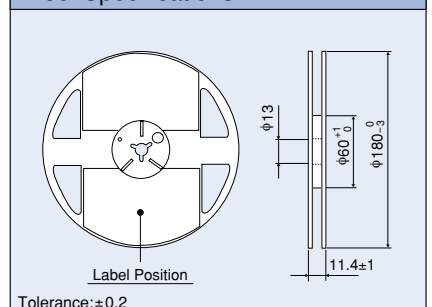

Electrical Characteristic Curves

Forward Current - Forward Voltage

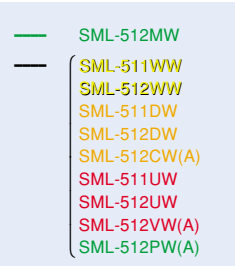
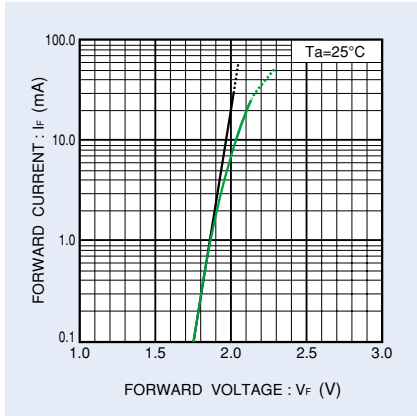

Relative Luminous Intensity - Case Temperature

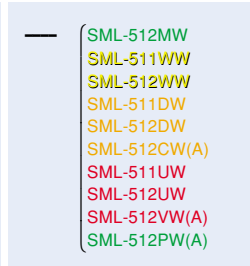
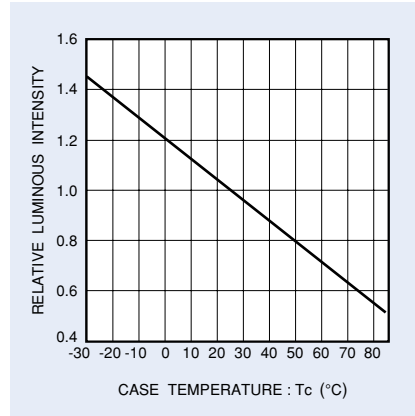

Relative Luminous Intensity - Forward Current

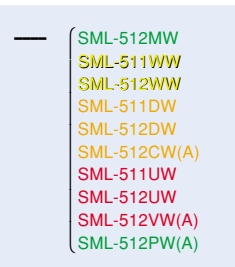
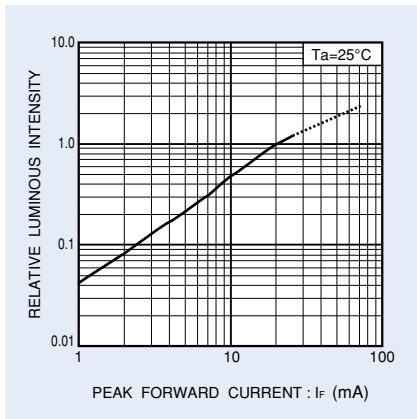

Ratio of Maximum Tolerable Peak Current - Pulse Duration

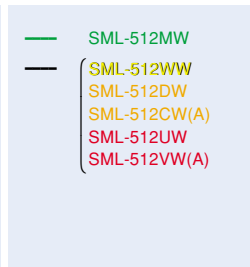
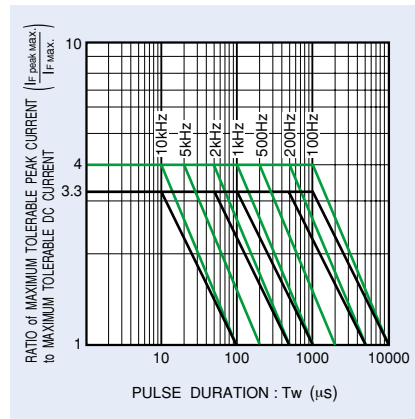

Ratio of Maximum Tolerable Peak Current - Pulse Duration

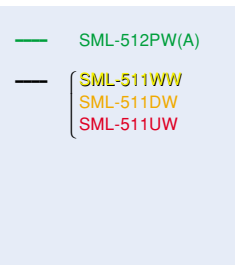
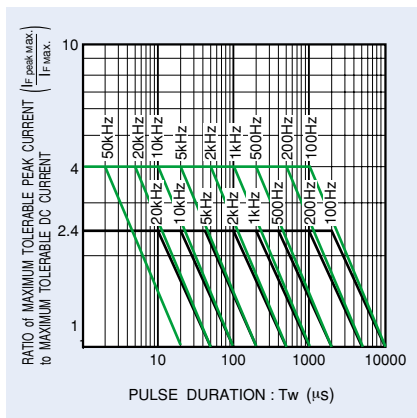

Derating

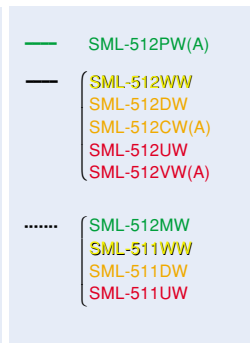
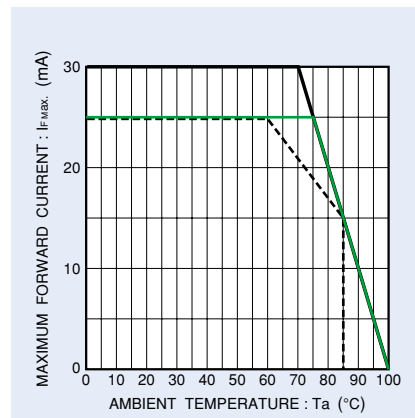

Notes

- No technical content pages of this document may be reproduced in any form or transmitted by any means without prior permission of ROHM CO.,LTD.
- The contents described herein are subject to change without notice. The specifications for the product described in this document are for reference only. Upon actual use, therefore, please request that specifications to be separately delivered.
- Application circuit diagrams and circuit constants contained herein are shown as examples of standard use and operation. Please pay careful attention to the peripheral conditions when designing circuits and deciding upon circuit constants in the set.
- Any data, including, but not limited to application circuit diagrams information, described herein are intended only as illustrations of such devices and not as the specifications for such devices. ROHM CO.,LTD. disclaims any warranty that any use of such devices shall be free from infringement of any third party's intellectual property rights or other proprietary rights, and further, assumes no liability of whatsoever nature in the event of any such infringement, or arising from or connected with or related to the use of such devices.
- Upon the sale of any such devices, other than for buyer's right to use such devices itself, resell or otherwise dispose of the same, no express or implied right or license to practice or commercially exploit any intellectual property rights or other proprietary rights owned or controlled by
- ROHM CO., LTD. is granted to any such buyer.
- Products listed in this document are no antiradiation design.

The products listed in this document are designed to be used with ordinary electronic equipment or devices (such as audio visual equipment, office-automation equipment, communications devices, electrical appliances and electronic toys).

Should you intend to use these products with equipment or devices which require an extremely high level of reliability and the malfunction of which would directly endanger human life (such as medical instruments, transportation equipment, aerospace machinery, nuclear-reactor controllers, fuel controllers and other safety devices), please be sure to consult with our sales representative in advance.

About Export Control Order in Japan

Products described herein are the objects of controlled goods in Annex 1 (Item 16) of Export Trade Control Order in Japan.

In case of export from Japan, please confirm if it applies to "objective" criteria or an "informed" (by MITI clause) on the basis of "catch all controls for Non-Proliferation of Weapons of Mass Destruction.