

SPGP0365A/SPGN0365A

VER : Preliminary
(SEMIHOW POWER SWITCH)

FEATURES

- Variable frequency operation
- Low Start-up Current(Typ.100uA)
- Pulse by Pulse Current Limiting
- Over Current Protection
- Over Voltage Protection (Min. 20)
- Internal Thermal Shutdown Function
- Under Voltage Lockout
- Internal High Voltage Sense FET
- Auto-Restart Mode
- Frequency Modulation for low EMI
- Advanced Burst-Mode Operation

APPLICATION

- SMPS for STB, SVR, DVD & DVCD
- SMPS for Printer, Facsimile & Scanner
- Adaptor

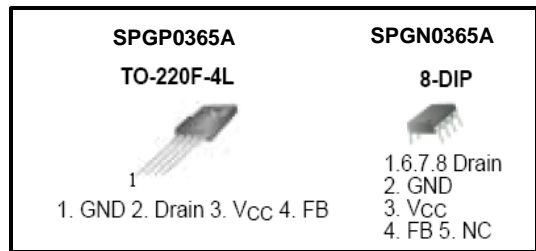

DESCRIPTION

The SemiHow Power Switch product family is specially designed for an off-line SMPS with minimal external components.

The SemiHow Power Switch consists of a high voltage power SenseFET and a current mode PWM IC.

It has a basic platform well suited for the cost effective design in either a flyback converter

INTERNAL BLOCK DIAGRAM

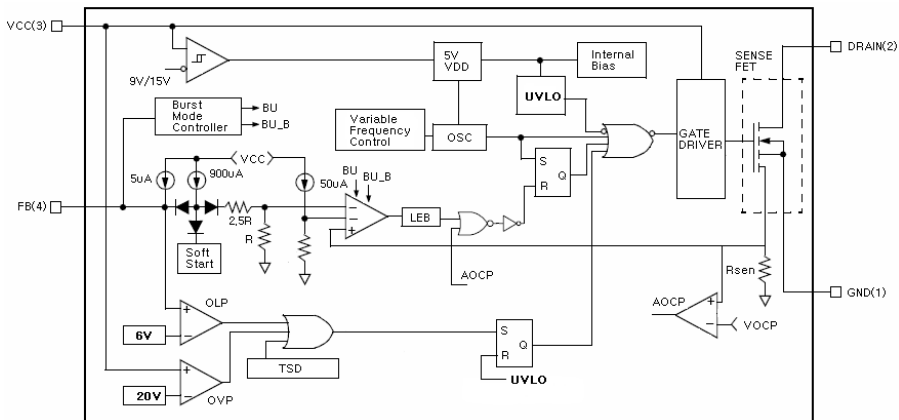

Absolute Maximum Ratings $T_C=25^\circ\text{C}$ unless otherwise specified

SPGP0365A

Symbol	Parameter	Value	Units
V_{DSS}	Drain-Source Voltage	650	V
I_D	Drain Current – Continuous ($T_C = 25^\circ\text{C}$)	3.0	A
	Drain Current – Continuous ($T_C = 100^\circ\text{C}$)	2.4	A
V_{GD}	Gate - source Voltage	± 30	V
I_{DM}	Drain Current – Pulsed (Note 1)	12	A
V_{GS}	Gate-Source Voltage	± 30	V
E_{AS}	Single Pulsed Avalanche Energy (Note 2)	358	mJ
$V_{CC(MAX)}$	Maximum Supply voltage	20	V
V_{FB}	Analog Input Voltage Range	-0.3 To V_{SD}	V
P_D	Power Dissipation ($T_C = 25^\circ\text{C}$) - Derate above 25°C	75	W
		0.6	W/ $^\circ\text{C}$
T_J	Operating Junction Temperature	+160	$^\circ\text{C}$
T_A	Operating Ambient Temperature	-25 to +85	$^\circ\text{C}$
T_{STG}	Storage Temperature Range	-55 to +150	$^\circ\text{C}$

SPGN0365A

Symbol	Parameter	Value	Units
V_{DSS}	Drain-Source Voltage	650	V
I_D	Drain Current – Continuous ($T_C = 25^\circ\text{C}$)	0.42	A
	Drain Current – Continuous ($T_C = 100^\circ\text{C}$)	0.28	A
V_{GD}	Gate - source Voltage	± 30	V
I_{DM}	Drain Current – Pulsed (Note 1)	3	A
V_{GS}	Gate-Source Voltage	± 30	V
E_{AS}	Single Pulsed Avalanche Energy (Note 2)	127	mJ
$V_{CC(MAX)}$	Maximum Supply voltage	20	V
V_{FB}	Analog Input Voltage Range	-0.3 To V_{SD}	V
P_D	Power Dissipation ($T_C = 25^\circ\text{C}$) - Derate above 25°C	1.56	W
		0.0125	W/ $^\circ\text{C}$
T_J	Operating Junction Temperature	+160	$^\circ\text{C}$
T_A	Operating Ambient Temperature	-25 to +85	$^\circ\text{C}$
T_{STG}	Storage Temperature Range	-55 to +150	$^\circ\text{C}$

Electrical Characteristics (SenseFet Part)

$T_C=25\text{ }^\circ\text{C}$ unless otherwise specified

Symbol	Parameter	Test Conditions	Min	Typ	Max	Units
On Characteristics						
$R_{DS(ON)}$	Static Drain-Source On-Resistance	$V_{GS} = 10\text{ V}, I_D = 0.5\text{ A}$	--	3.6	4.5	Ω
Off Characteristics						
BV_{DSS}	Drain-Source Breakdown Voltage	$V_{GS} = 0\text{ V}, I_D = 50\text{ }\mu\text{A}$	650	--	--	V
I_{DSS}	Zero Gate Voltage Drain Current	$V_{DS} = 650\text{ V}, V_{GS} = 0\text{ V}$	--	--	50	μA
		$V_{DS} = 520\text{ V}, T_C = 125\text{ }^\circ\text{C}$	--	--	200	μA
Dynamic Characteristics						
C_{iss}	Input Capacitance	$V_{DS} = 25\text{ V}, V_{GS} = 0\text{ V},$ $f = 1.0\text{ MHz}$	--	950	1230	pF
C_{oss}	Output Capacitance		--	550	710	pF
C_{rss}	Reverse Transfer Capacitance		--	120	155	pF
Switching Characteristics						
$t_{d(on)}$	Turn-On Time	$V_{DS} = 325\text{ V}, I_D = 1\text{ A},$ $R_G = 25\text{ }\Omega$ (Note 4,5)	--	18	--	ns
T_r	Turn-On Rise Time		--	12	--	ns
$t_{d(off)}$	Turn-Off Delay Time		--	80	--	ns
t_f	Turn-Off Fall Time		--	22	--	ns
Q_g	Total Gate Charge	$V_{DS} = 325\text{ V}, I_D = 1\text{ A},$ $V_{GS} = 10\text{ V}$ (Note 4,5)	--	13	17	nC
Q_{gs}	Gate-Source Charge		--	2.0	--	nC
Q_{gd}	Gate-Drain Charge		--	5.5	--	nC

Notes ;

1. Repetitive Rating : Pulse width limited by maximum junction temperature
2. $L=14.2\text{mH}, I_{AS}=9.5\text{A}, V_{DD}=50\text{V}, R_G=25\Omega,$ Starting $T_J=25\text{ }^\circ\text{C}$
3. $I_{SD}\leq 9.5\text{A}, di/dt\leq 200\text{A}/\mu\text{s}, V_{DD}\leq BV_{DSS},$ Starting $T_J=25\text{ }^\circ\text{C}$
4. Pulse Test : Pulse Width $\leq 300\mu\text{s},$ Duty Cycle $\leq 2\%$
5. Essentially Independent of Operating Temperature

Electrical Characteristics (Control Part)

$T_C=25^\circ\text{C}$ unless otherwise specified

Symbol	Parameter	Test Conditions	Min	Typ	Max	Units
UVLO Section						
V_{START}	Start Threshold Voltage	$V_{FB} = \text{GND}$	14	15	16	V
V_{STOP}	Stop Threshold Voltage	$V_{FB} = \text{GND}$	8.4	9	9.6	V
Oscillator Section						
F_{OSC}	Initial Accuracy		57	64	71	KHz
--	Frequency Change With Temperature (Note 2)	$-25^\circ\text{C} \leq T_a \leq +85^\circ\text{C}$	--	± 5	± 10	%
D_{MAX}	Maximum Duty Cycle		73	77	82	%
FEEDBACK Section						
I_{FB}	Feedback Source Current	$T_a=25^\circ\text{C}, 0V < V_{fb} < 3V$	0.7	0.9	1.1	mA
V_{SD}	Shutdown Feedback Voltage	$V_{fb} > 6.5V$	5.4	6	6.6	V
I_{delay}	Shutdown Delay Current	$T_a=25^\circ\text{C}, 5V \delta V_{fb} \delta V_{SD}$	4	5	6	mA
Reference Section						
V_{REF}	Reference Output Voltage (Note 1)	$T_a=25^\circ\text{C}$	4.8	5	5.2	V
$V_{ref}/\Delta T$	Temperature Stability (Note 1, 2)	$-25^\circ\text{C} \leq T_a \leq +85^\circ\text{C}$	--	0.3	0.6	mV/ $^\circ\text{C}$
I_{OVER}	Peak Current Limit	Max. inductor current	1.62	2.0	2.38	A
Protection Section						
V_{OVP}	Over Voltage Protection	$V_{CC} > 20V$	20	--	23	V
T_{SD}	Thermal Shutdown Temperature (T_j) (Note 1)	--	140	160	--	$^\circ\text{C}$
Protection Section						
I_{START}	Start-up Current	$V_{CC} = 14V$	--	100	170	μA
I_{OP}	Operating Supply Current (Control Part Only)	$V_{CC} < 20V$	--	3	6	mA

Notes ;

1. These parameters, although guaranteed, are not 100% tested in production
2. These parameters, although guaranteed, are tested in EDS(water test) process

Typical Characteristics

(SPGP0365A)

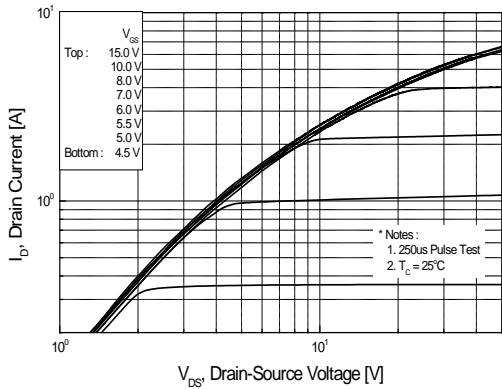

Figure 1. On Region Characteristics

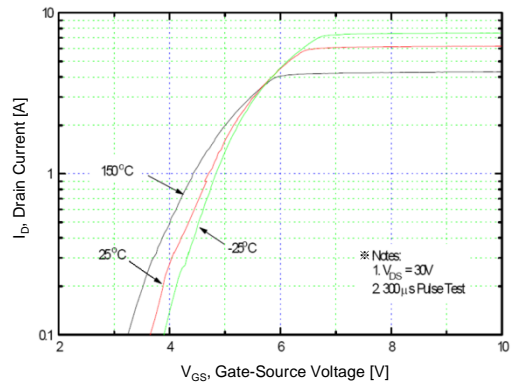

Figure 2. Transfer Characteristics

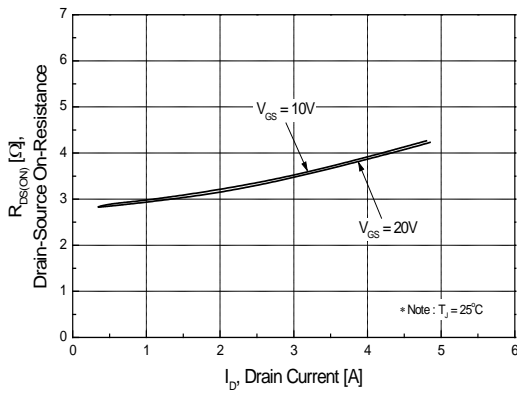

Figure 3. On Resistance Variation vs Drain Current and Gate Voltage

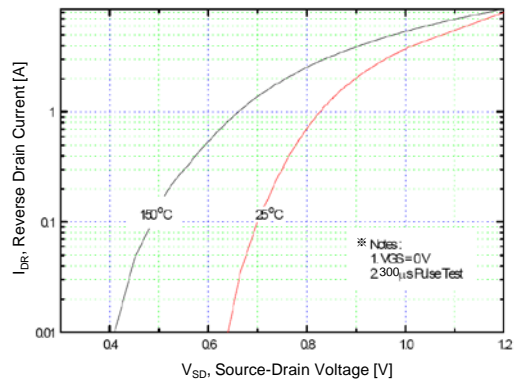

Figure 4. Body Diode Forward Voltage Variation with Source Current and Temperature

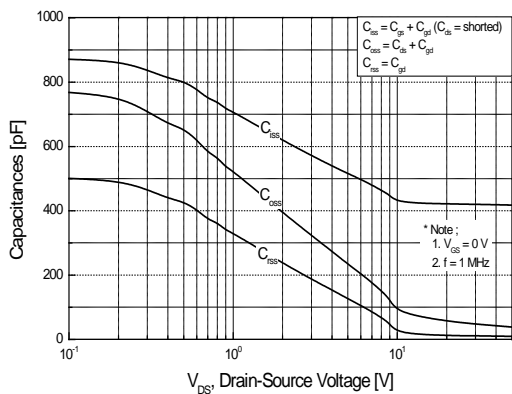

Figure 5. Capacitance Characteristics

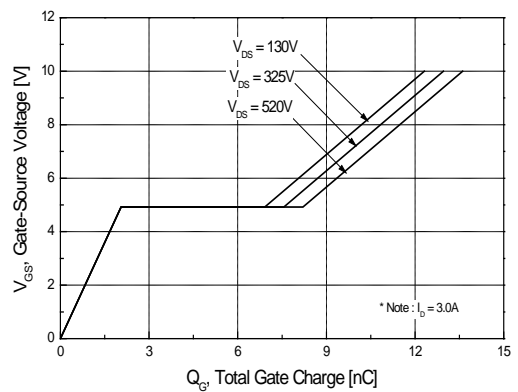

Figure 6. Gate Charge Characteristics

Typical Characteristics (continued)

(SPGP0365A)

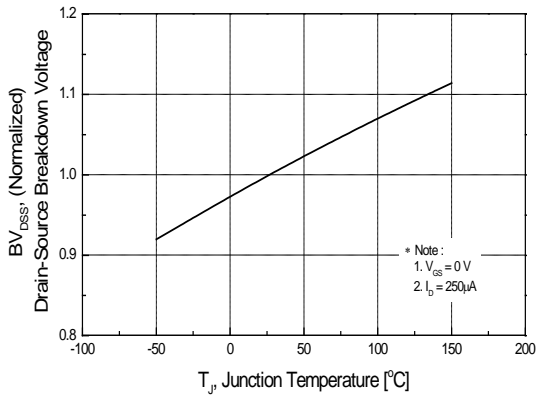

Figure 7. Breakdown Voltage Variation vs Temperature

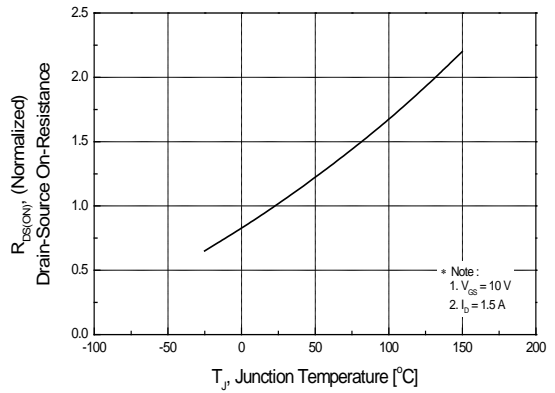

Figure 8. On-Resistance Variation vs Temperature

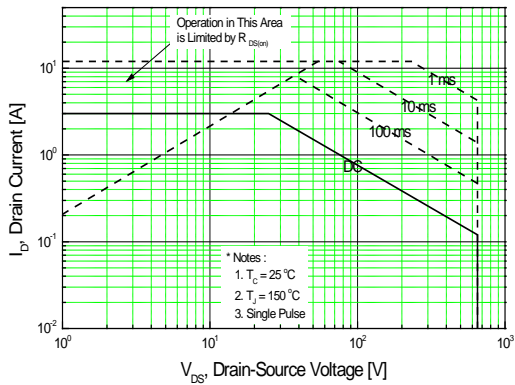

Figure 9. Maximum Safe Operating Area

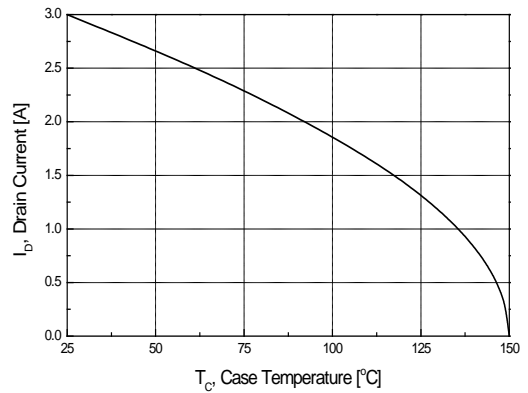

Figure 10. Maximum Drain Current vs Case Temperature

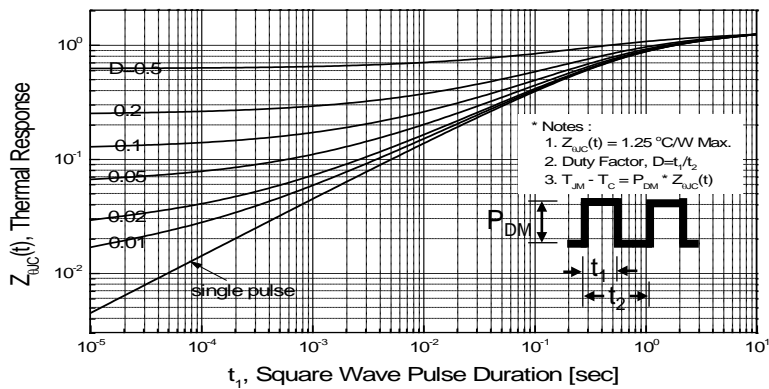

Figure 11. Transient Thermal Response Curve

Typical Characteristics

(SPGN0365A)

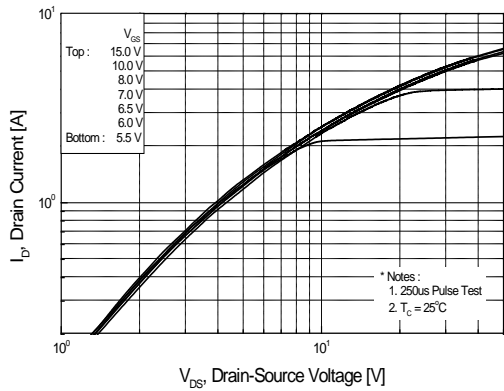

Figure 1. On Region Characteristics

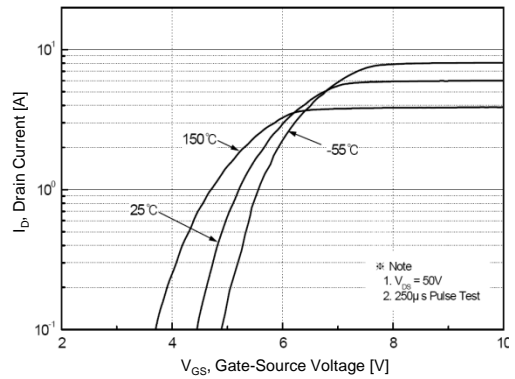

Figure 2. Transfer Characteristics

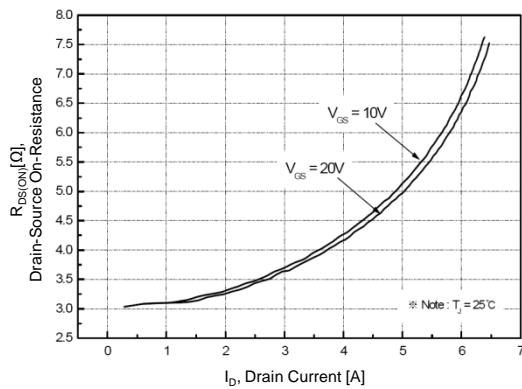

Figure 3. On Resistance Variation vs Drain Current and Gate Voltage

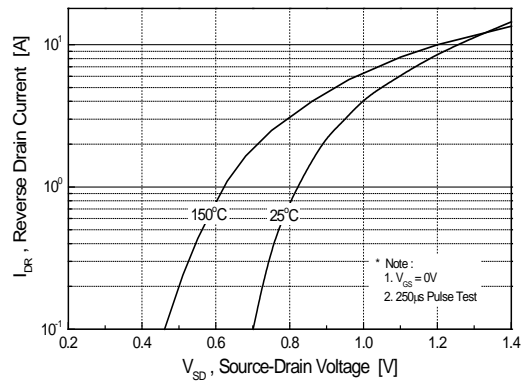

Figure 4. Body Diode Forward Voltage Variation with Source Current and Temperature

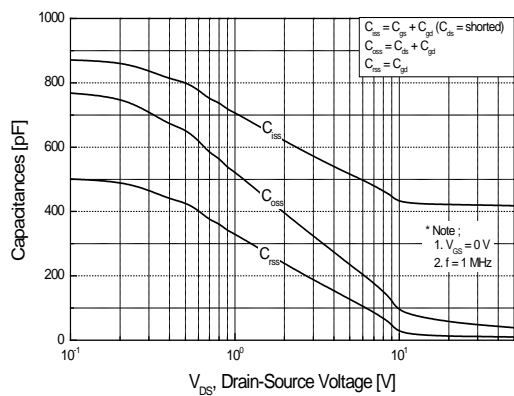

Figure 5. Capacitance Characteristics

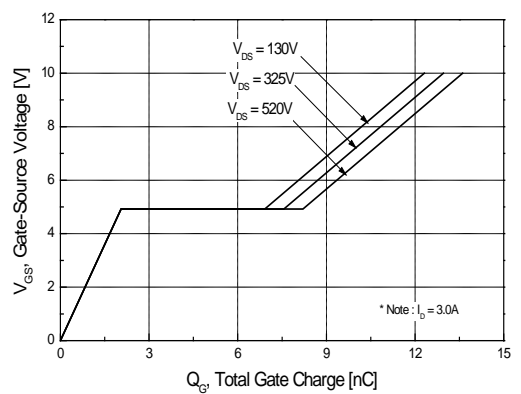

Figure 6. Gate Charge Characteristics

Typical Characteristics (continued)

(SPGN0365A)

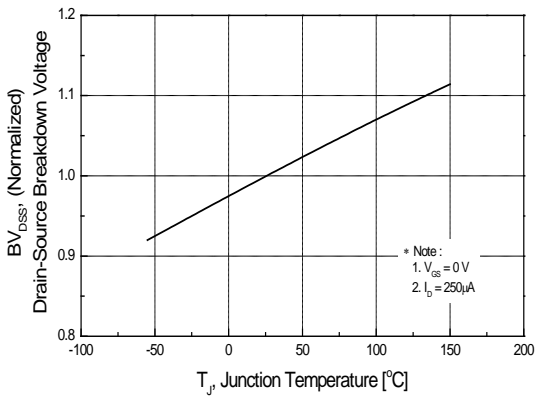

Figure 7. Breakdown Voltage Variation vs Temperature

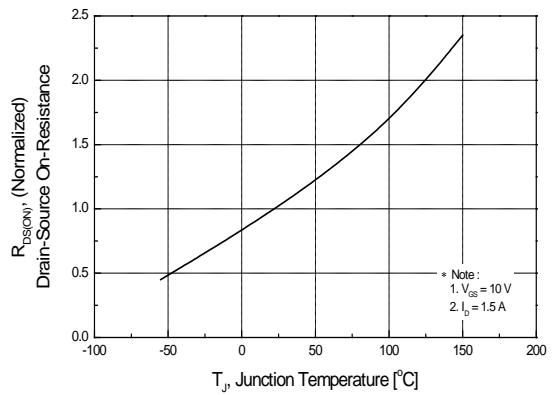

Figure 8. On-Resistance Variation vs Temperature

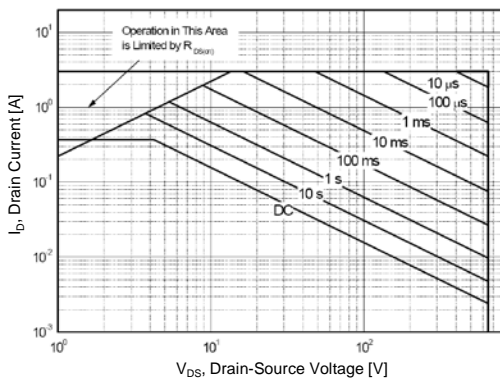

Figure 9. Maximum Safe Operating Area

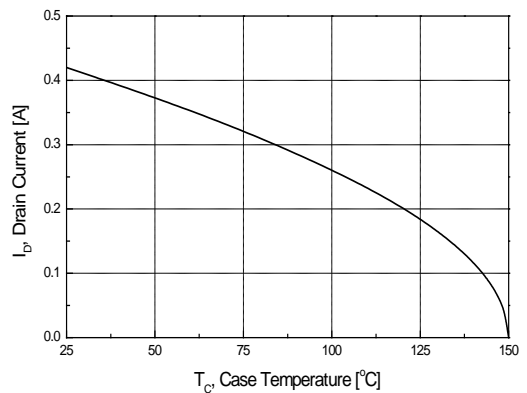

Figure 10. Maximum Drain Current vs Case Temperature

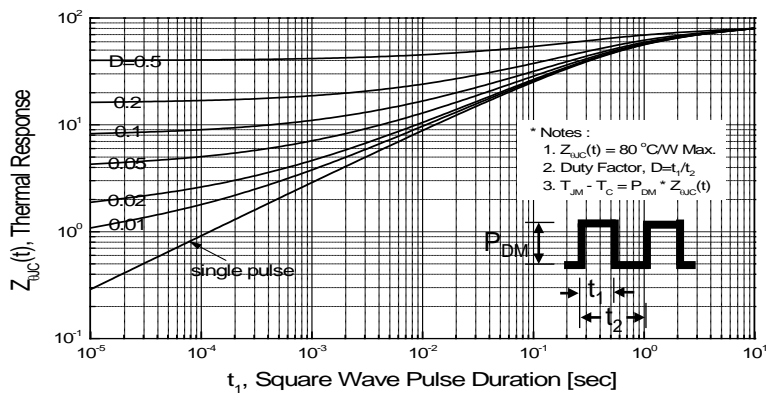
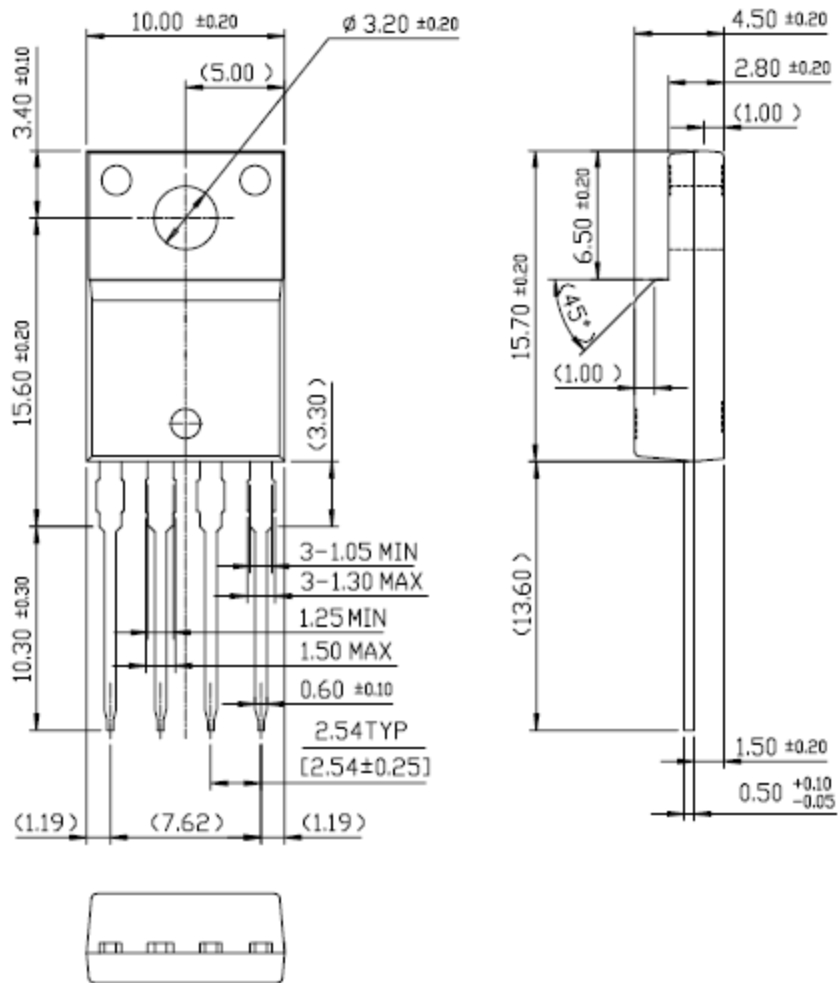

Figure 11. Transient Thermal Response Curve

Package Dimension

TO-220F-4L



8-DIP

