

- Designed to match Infineon Technologies VDSL Solutions
- Bandpass Filter with Integrated Hybrid Transformer
- Robust construction allows for IR/VP processes
- 1500 Vrms Isolation

Electrical Parameters @ 25° C

Impedance (Ω)	Impedance (Ω)	Insertion Loss ¹ (dB Max.)	Return Loss (dB Min.)	Attenuation (dB Min.)		Transhybrid Isolation (dB Typ.)
Cable Side	Xmit / Rcv	900 KHz - 7.9 MHz	900 KHz - 7.9 MHz	20 KHz - 150 KHz	@ 40 MHz	900 KHz - 7.9 MHz
120	40 / 270	-0.8	-10	-60	-15	15

• **Note 1** : Referenced to 2.7 MHz Center Frequency •

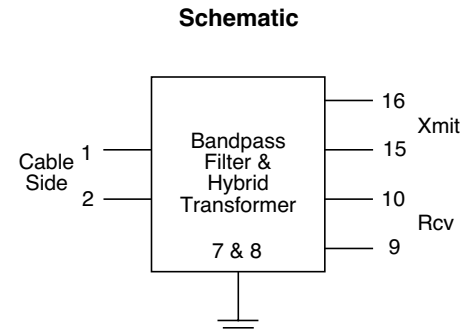
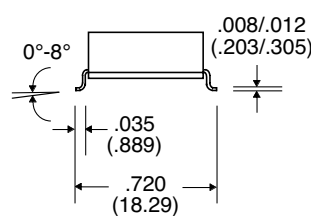
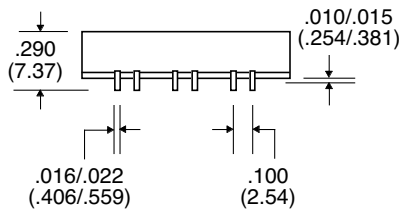
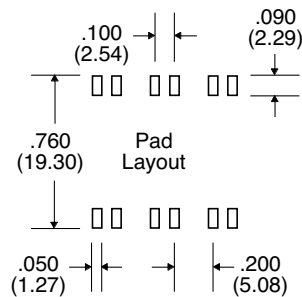
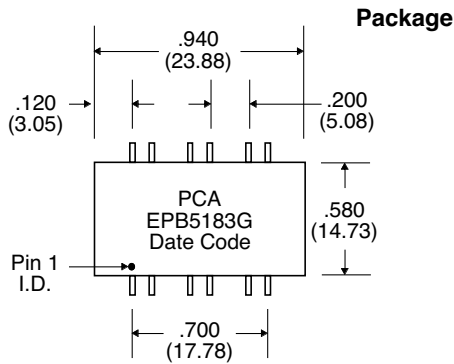
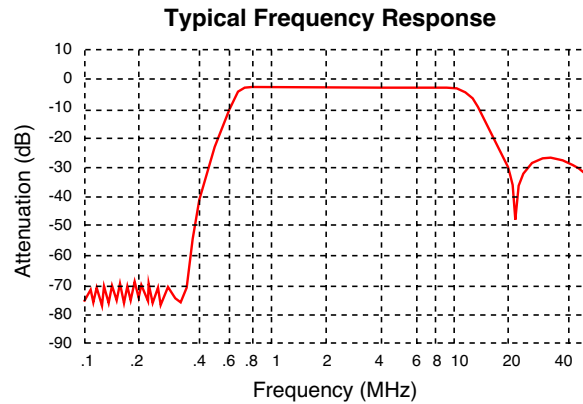
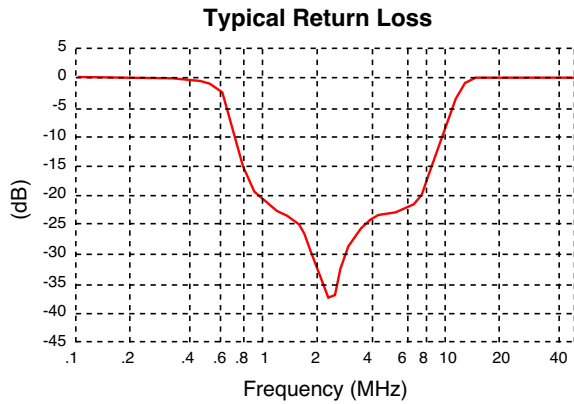

Unless Otherwise Specified Dimensions are in Inches /mm ±.010 /.25