

Temperature Monitoring Relay K8AB-TH

CSM_K8AB-TH_DS_E_2_1

Compact and Slim Relay Ideal for Temperature Alarms and Monitoring

- Excessive temperature increases can be prevented and abnormal temperatures can be monitored.
- Temperature monitoring in slim design with a width of just 22.5 mm.
- Simple function settings using DIP switch.
- Universal-input support for thermocouple or Pt100 sensor input.
- Selectable output relay: Non-fail safe/fail safe.
- Alarm status identification with LED indicator.

 Refer to *Safety Precautions for All Temperature Controllers.*

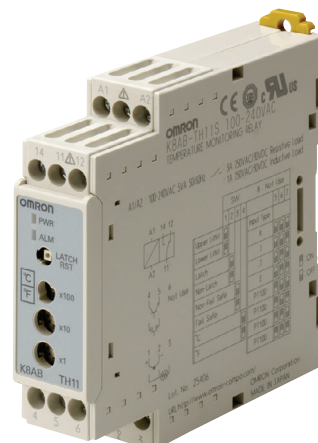

Features

- This Temperature Monitoring Relay was designed specially for monitoring abnormal temperatures to prevent excessive temperature increase and to protect equipment.
- A relay capacity of 3 A at 250 VAC (resistive load) is provided in a slim body only 22.5 mm wide. An output latch function is also supported.
- Settings can be made and functions can be selected using the DIP switch.
- Reduce the number of models by using universal-input support for thermocouple or Pt100 sensor input.

Selecting Functions and Modes

- The following settings are provided: alarm mode (upper limit/lower limit), enable/disable latch, °C/°F, relay output non-fail safe/fail safe, setting protection.

Terminal Wiring with Ferrules

- Wire with 2 × 2.5 mm² solid wire or 2 × 1.5 mm² wiring ferrules.

Third-party Certification of CE Mark Compliance, Certified UL Standard Compliance, and Certified TÜV and SUD Standard Compliance



Model Number Structure

Model Number Legend

K8AB-TH1□□□
1 2 3 4

1. Basic Model

K8AB: Measuring and Monitoring Relay

2. Function

TH1: Temperature Monitoring Relay

3. Setting Range

- 1: Low-temperature range (0 to 399°C: setting in increments of 1°C)
- 2: High-temperature range (0 to 1700°C max.: setting in increments of 10°C)

4. Output Form

S: One SPDT relay output

Ordering Information

List of Models

Size	Supply voltage	Type	Number of outputs	Input type	Setting unit (setting range)	Model
K8AB-TH 22.5 × 90 × 100 mm	100 to 240 VAC	Temperature input	1 (relay)	Thermocouple/Pt100	Unit: 1°C/°F (0 to 399°C/°F)	K8AB-TH11S
				Thermocouple	Unit: 10°C/°F (See note 1.)	K8AB-TH12S
	24 VAC/VDC			Thermocouple/Pt100	Unit: 1°C/°F (0 to 399°C/°F)	K8AB-TH11S
				Thermocouple	Unit: 10°C/°F (See note 1.)	K8AB-TH12S

Note: 1. Refer to page 3 for setting ranges.

2. Specify the power supply voltage when ordering. Different models must be ordered for 100 to 240 VAC and 24 VAC/DC.

Specifications

■ Ratings

Item	Power supply voltage	100 to 240 VAC 50/60 Hz	24 VAC 50/60 Hz or 24 VDC
Allowable voltage range		85% to 110% of power supply voltage	
Power consumption		5 VA max.	2 W max. (24 VDC), 4 VA max. (24 VAC)
Sensor inputs	K8AB-TH11S	Thermocouple: K, J, T, E; Platinum-resistance thermometer: Pt100	
	K8AB-TH12S	Thermocouple: K, J, T, E, B, R, S, PLII	
Output relay		One SPDT relay (3 A at 250 VAC, resistive load)	
External inputs (for latch setting)	Contact input	ON: 1 k Ω max., OFF: 100 k Ω min.	
	Non-contact input	ON residual voltage: 1.5 V max., OFF leakage current: 0.1 mA max. Leakage current: Approx. 10 mA	
Setting method		Rotary switch setting (set of three switches)	
Indicators		Power (PWR): Green LED, Relay output (ALM): Red LED	
Other functions		Alarm Mode (upper limit/lower limit), non-fail safe/fail safe selection, output latch, setting protection, temperature unit $^{\circ}\text{C}/^{\circ}\text{F}$	
Ambient operating temperature		-10 to 55 $^{\circ}\text{C}$ (with no condensation or icing)	
Ambient operating humidity		Relative humidity: 25% to 85%	
Storage temperature		-25 to 65 $^{\circ}\text{C}$ (with no condensation or icing)	

■ Characteristics

Setting accuracy	$\pm 2.0\%$ of full scale		
hysteresis width	2 $^{\circ}\text{C}$		
Output relay	Resistive load	3 A at 250 VAC ($\cos\phi = 1$), 3 A at 30 VDC (L/R = 0 ms)	
	Inductive load	1 A at 250 VAC ($\cos\phi = 0.4$), 1 A at 30 VDC (L/R = 7 ms)	
	Minimum load	10 mA at 5 VDC	
	Maximum contact voltage	250 VAC	
	Maximum contact current	3 A AC	
	Maximum switching capacity	1,500 VA	
	Mechanical life	10,000,000 operations	
	Electrical life	Make: 50,000 times, Break: 30,000 times	
Sampling cycle	500 ms		
Insulation resistance	20 M Ω (at 500 V) between charged terminals and exposed uncharged parts 20 M Ω (at 500 V) between any charged terminals (i.e., between input, output, and power supply terminals) 20 M Ω (at 500 V) between contacts (open)		
Dielectric strength	2,000 VAC 50/60 Hz for 1 min between charged terminals of different polarity		
Vibration resistance	Vibration of 10 to 55 Hz and acceleration of 50 m/s 2 for 5 min with 10 sweeps each in X, Y, and Z directions		
Shock resistance	150 m/s 2 (100 m/s 2 for relay contacts) 3 times each in 6 directions in X, Y, and Z directions		
Weight	130 g		
Degree of protection	IP20		
Memory protection	Non-volatile memory (number or writes: 200,000)		
Safety Standards	Approved standards	EN 61010-1	
	EMC	EN 61326	
	Application standards	EN 61010-1 (pollution level 2, overvoltage category II)	
EMC	EMI:	EN 61326	
	Radiation Interference Field Intensity:	EN 55011 Group 1 Class A	
	Noise Terminal Voltage:	EN 55011 Group 1 Class A	
	EMS:	EN 61326	
	Immunity ESD:	EN 61000-4-2:	4 kV contact discharge (level 2) 8 kV air discharge (level 3)
	Immunity RF:	EN 61000-4-3:	10 V/m, amplitude-modulated (80 MHz to 1 GHz, 1.4 GHz to 2 GHz) (level 3)
	Immunity Burst:	EN 61000-4-4:	2 kV power line (level 3) 2 kV output line (relay output) (level 4) 1 kV measurement line and I/O signal lines (level 4)
	Immunity Conducted Disturbance:	EN 61000-4-6:	3 V (0.15 to 80 MHz) (level 3)
	Immunity Surge:	EN 61000-4-5:	1 kV line-to-line: power line, output line (relay output) (level 2) 2 kV line-to-ground: power line, output line (relay output) (level 3)
	Commercial Frequency Immunity Magnetic Field:	EN 61000-4-8:	30 A/m (50Hz) continuous time
Immunity Voltage Dip/Interrupting:	EN 61000-4-11:	0.5 cycle, 100% (rated voltage)	
Terminal screw tightening torque	0.54 to 0.55 N-m		
Crimp terminals	Two solid wires of 2.5 mm 2 or two ferrules of 1.5 mm 2 with insulation sleeves can be tightened together.		
Case color	Munsell 5Y8/1 (ivory)		
Case material	ABS resin (self-extinguishing resin)		
Mounting	Mounted to DIN Track or with M4 screws		
Dimensions	22.5 \times 100 \times 90 mm (W \times D \times H)		

■ Setting Ranges

K8AB-TH11S

Centigrade

Input	K	J	T	E	Pt100
Setting temperature range	500 400 300 200 100 0	399 399 399 399 399 0	399 399 399 399 399 0	399 399 399 399 399 0	399 399 399 399 399 0
Minimum setting increment	1°C				

Fahrenheit

Input	K	J	T	E	Pt100
Setting temperature range	500 400 300 200 100 0	399 399 399 399 399 0	399 399 399 399 399 0	399 399 399 399 399 0	399 399 399 399 399 0
Minimum setting increment	1°F				

K8AB-TH12S

Centigrade

Input	K	J	T	E	B	R	S	PLII
Setting temperature range	1,800 1,700 1,600 1,500 1,400 1,300 1,200 1,100 1,000 900 800 700 600 500 400 300 200 100 0	1,300 850 400 0	850 400 0	600 0	1,800 100	1,700 0	1,700 0	1,300 0
Minimum setting increment	10°C							

Fahrenheit

Input	K	J	T	E	B	R	S	PLII
Setting temperature range	3,200 3,100 3,000 2,900 2,800 2,700 2,600 2,500 2,400 2,300 2,200 2,100 2,000 1,900 1,800 1,700 1,600 1,500 1,400 1,300 1,200 1,100 1,000 900 800 700 600 500 400 300 200 100 0	2,300 1,500 700 0	1,500 700 0	1,100 0	3,200 300	3,000 0	3,000 0	2,300 0
Minimum setting increment	10°F							

Connections

Wiring Diagrams

K8AB-TH11S

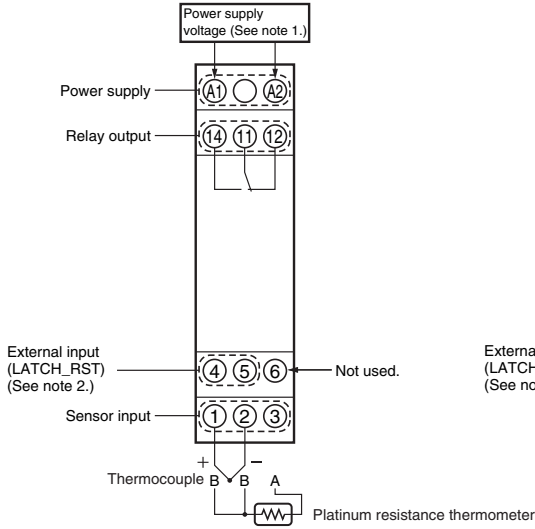

K8AB-TH12S

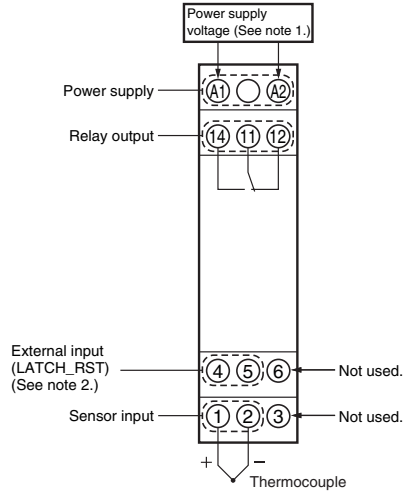

- Note: 1.** The input power supply depends on the model: 100 to 240 VAC or 24 VAC/VDC (no polarity)
- 2.** Wiring of the external input terminals is as shown below.

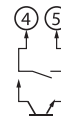

Operation (Using the Upper-limit Alarm Mode)

Output Latch Enabled (Default Setting: Latch Enabled)

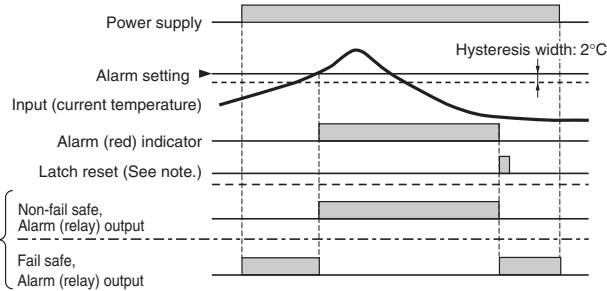

Note: The output latch is reset using the output latch reset button on the Temperature Monitoring Relay or the external input terminal.

Output Latch Disabled

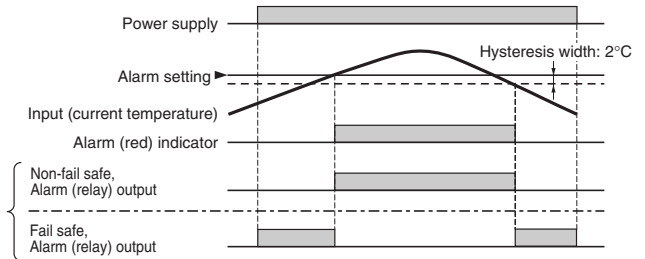

Nomenclature

Front Operations

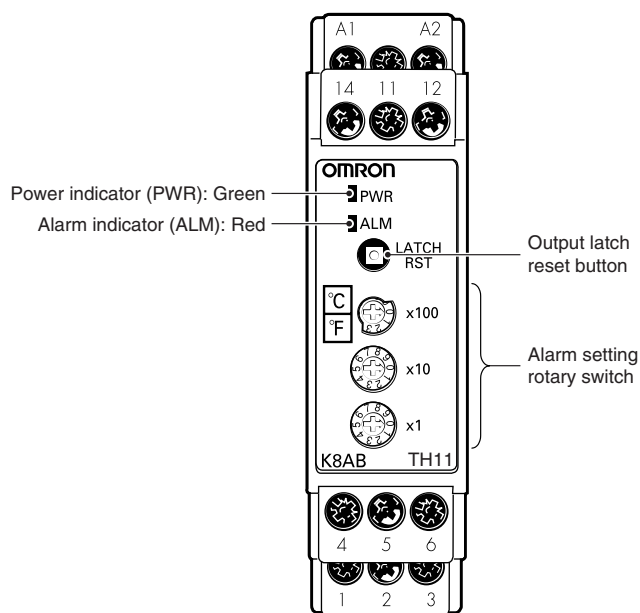

Indicators

Item	Usage
Power indicator (PWR)	Lit: Power supply is ON. Flashing: SV protected.
Alarm indicator (ALM)	Lit: Relay is operating. Flashing: Sensor is disconnected or there is a Temperature Monitoring Relay error. (See note 1.).

Operation Switches

Item	Usage
Output latch reset button	The output latch can be reset by pressing this button. (Enabled when latch is enabled.) (See note 2.)
Alarm setting rotary switch	Set each digit of the alarm set temperature. K8AB-TH11S: x1, x10, x100 digits K8AB-TH12S: x10, x100, x1000 digits

- Note:**
- The ALM indicator will flash and the relay outputs will turn ON if any of the following conditions occur.
 - The temperature input value exceeds the specified range.
 - The temperature set value exceeds the specified range.
 - There is an error in the internal circuits.
 - The SV protection will function when the latch reset button is pressed for at least 5 s.
The power indicator will flash when the SV is protected. To release the protection, press the latch reset button again for at least 5 s.

Alarm Setting Rotary Switch



Turn the arrow in the direction of the number to set.

Function Setting DIP Switch

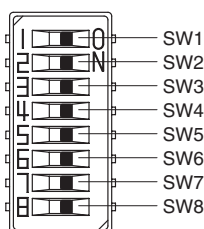

This DIP switch is provided on the side of the Temperature Monitoring Relay. (All switches are OFF for the default settings.)



	Function	Function		Default
		OFF	ON	
SW1	Alarm mode	OFF	Upper-limit alarm	OFF
		ON	Lower-limit alarm	
SW2	Output latch selector	OFF	Enabled	OFF
		ON	Disabled	
SW3	Operation selector: Non-fail safe/fail safe	OFF	Non-fail safe	OFF
		ON	Fail safe	
SW4	Temperature unit	OFF	°C	OFF
		ON	°F	
SW5	Input type selector	Refer to the following table.		OFF
SW6		OFF		
SW7		OFF		
SW8		Not used.	---	OFF

K8AB-TH11S

	Sensor type							
	K	J	T	E	Pt100*	Pt100*	Pt100*	Pt100*
SW5	OFF	OFF	OFF	OFF	ON	ON	ON	ON
SW6	OFF	OFF	ON	ON	OFF	OFF	ON	ON
SW7	OFF	ON	OFF	ON	OFF	ON	OFF	ON

* The type will be Pt100 for any of these settings.

K8AB-TH12S

	Sensor type							
	K	J	T	E	B	R	S	PLII
SW5	OFF	OFF	OFF	OFF	ON	ON	ON	ON
SW6	OFF	OFF	ON	ON	OFF	OFF	ON	ON
SW7	OFF	ON	OFF	ON	OFF	ON	OFF	ON

■ Functions

SV Protection

This function protects (i.e., prohibits changing) the alarm setting, operating method, and modes for the Temperature Monitoring Relay that have been set on the rotary switches and DIP switch.

The protection function is activated by pressing the output latch reset button on the Temperature Monitoring Relay for at least 5 s or by turning ON the input to the external input terminal for at least 5 s.

The power indicator will flash when the protection is activated.

The protection function can be released by pressing the output latch reset button on the Temperature Monitoring Relay for at least 5 s or by turning ON the input to the external input terminal for at least 5 s.

The power indicator will light while the protection is being reset.

Dimensions

Note: All units are in millimeters unless otherwise indicated.

■ Temperature Monitoring Relay

K8AB-TH

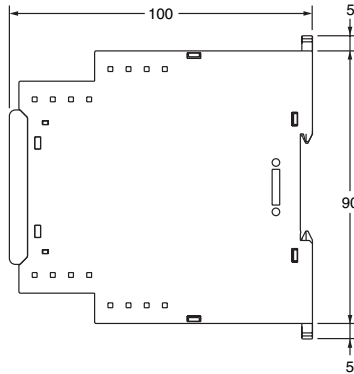
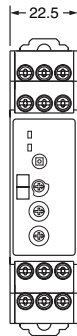
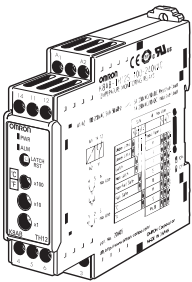

Mounting Hole Dimensions

Two, M4 screws or two, 4-dia screws

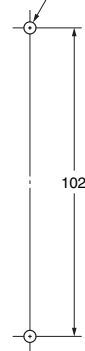

Note: Pull out and use the hooks when mounting using screws.

■ Track Mounting Products (Sold Separately)

Mounting Track

PFP-100N
PFP-50N

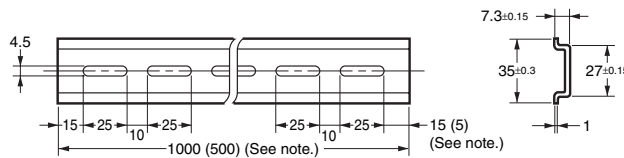
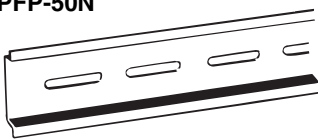

Note: Dimensions in parentheses are for the PFP-50N.

Safety Precautions

Refer to *Safety Precautions for All Temperature Controllers*.

ALL DIMENSIONS SHOWN ARE IN MILLIMETERS.
To convert millimeters into inches, multiply by 0.03937. To convert grams into ounces, multiply by 0.03527.

In the interest of product improvement, specifications are subject to change without notice.

Read and Understand This Catalog

Please read and understand this catalog before purchasing the products. Please consult your OMRON representative if you have any questions or comments.

Warranty and Limitations of Liability

WARRANTY

OMRON's exclusive warranty is that the products are free from defects in materials and workmanship for a period of one year (or other period if specified) from date of sale by OMRON.

OMRON MAKES NO WARRANTY OR REPRESENTATION, EXPRESS OR IMPLIED, REGARDING NON-INFRINGEMENT, MERCHANTABILITY, OR FITNESS FOR PARTICULAR PURPOSE OF THE PRODUCTS. ANY BUYER OR USER ACKNOWLEDGES THAT THE BUYER OR USER ALONE HAS DETERMINED THAT THE PRODUCTS WILL SUITABLY MEET THE REQUIREMENTS OF THEIR INTENDED USE. OMRON DISCLAIMS ALL OTHER WARRANTIES, EXPRESS OR IMPLIED.

LIMITATIONS OF LIABILITY

OMRON SHALL NOT BE RESPONSIBLE FOR SPECIAL, INDIRECT, OR CONSEQUENTIAL DAMAGES, LOSS OF PROFITS OR COMMERCIAL LOSS IN ANY WAY CONNECTED WITH THE PRODUCTS, WHETHER SUCH CLAIM IS BASED ON CONTRACT, WARRANTY, NEGLIGENCE, OR STRICT LIABILITY.

In no event shall the responsibility of OMRON for any act exceed the individual price of the product on which liability is asserted.

IN NO EVENT SHALL OMRON BE RESPONSIBLE FOR WARRANTY, REPAIR, OR OTHER CLAIMS REGARDING THE PRODUCTS UNLESS OMRON'S ANALYSIS CONFIRMS THAT THE PRODUCTS WERE PROPERLY HANDLED, STORED, INSTALLED, AND MAINTAINED AND NOT SUBJECT TO CONTAMINATION, ABUSE, MISUSE, OR INAPPROPRIATE MODIFICATION OR REPAIR.

Application Considerations

SUITABILITY FOR USE

OMRON shall not be responsible for conformity with any standards, codes, or regulations that apply to the combination of products in the customer's application or use of the products.

At the customer's request, OMRON will provide applicable third party certification documents identifying ratings and limitations of use that apply to the products. This information by itself is not sufficient for a complete determination of the suitability of the products in combination with the end product, machine, system, or other application or use.

The following are some examples of applications for which particular attention must be given. This is not intended to be an exhaustive list of all possible uses of the products, nor is it intended to imply that the uses listed may be suitable for the products:

- Outdoor use, uses involving potential chemical contamination or electrical interference, or conditions or uses not described in this catalog.
- Nuclear energy control systems, combustion systems, railroad systems, aviation systems, medical equipment, amusement machines, vehicles, safety equipment, and installations subject to separate industry or government regulations.
- Systems, machines, and equipment that could present a risk to life or property.

Please know and observe all prohibitions of use applicable to the products.

NEVER USE THE PRODUCTS FOR AN APPLICATION INVOLVING SERIOUS RISK TO LIFE OR PROPERTY WITHOUT ENSURING THAT THE SYSTEM AS A WHOLE HAS BEEN DESIGNED TO ADDRESS THE RISKS, AND THAT THE OMRON PRODUCTS ARE PROPERLY RATED AND INSTALLED FOR THE INTENDED USE WITHIN THE OVERALL EQUIPMENT OR SYSTEM.

PROGRAMMABLE PRODUCTS

OMRON shall not be responsible for the user's programming of a programmable product, or any consequence thereof.

Disclaimers

CHANGE IN SPECIFICATIONS

Product specifications and accessories may be changed at any time based on improvements and other reasons.

It is our practice to change model numbers when published ratings or features are changed, or when significant construction changes are made. However, some specifications of the products may be changed without any notice. When in doubt, special model numbers may be assigned to fix or establish key specifications for your application on your request. Please consult with your OMRON representative at any time to confirm actual specifications of purchased products.

DIMENSIONS AND WEIGHTS

Dimensions and weights are nominal and are not to be used for manufacturing purposes, even when tolerances are shown.

PERFORMANCE DATA

Performance data given in this catalog is provided as a guide for the user in determining suitability and does not constitute a warranty. It may represent the result of OMRON's test conditions, and the users must correlate it to actual application requirements. Actual performance is subject to the OMRON Warranty and Limitations of Liability.

ERRORS AND OMISSIONS

The information in this document has been carefully checked and is believed to be accurate; however, no responsibility is assumed for clerical, typographical, or proofreading errors, or omissions.

2008.12

In the interest of product improvement, specifications are subject to change without notice.

OMRON Corporation
Industrial Automation Company

<http://www.ia.omron.com/>

(c)Copyright OMRON Corporation 2008 All Right Reserved.