

MMBZ27VCWT1G

40 Watt Peak Power Zener Transient Voltage Suppressors

SC-70 Dual Common Cathode Zeners for ESD Protection

These dual monolithic silicon zener diodes are designed for applications requiring transient overvoltage protection capability. They are intended for use in voltage and ESD sensitive equipment such as computers, printers, business machines, communication systems, medical equipment and other applications. Their dual junction common cathode design protects two separate lines using only one package. These devices are ideal for situations where board space is at a premium.

Specification Features:

- SC-70 Package Allows Either Two Separate Unidirectional Configurations or a Single Bidirectional Configuration
- Working Peak Reverse Voltage Range – 22 V
- Standard Zener Breakdown Voltage – 27 V
- Peak Power – 40 W @ 1.0 ms (Bidirectional), per Figure 4 Waveform
- ESD Rating of Class N (exceeding 16 kV) per the Human Body Model
- Low Leakage < 100 nA
- Flammability Rating: UL 94 V-O
- This is a Pb-Free Device

Mechanical Characteristics:

CASE: Void-free, transfer-molded, thermosetting plastic case

FINISH: Corrosion resistant finish, easily solderable

MAXIMUM CASE TEMPERATURE FOR SOLDERING PURPOSES:
260°C for 10 Seconds



ON Semiconductor®

<http://onsemi.com>

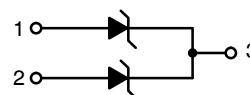

PIN 1. ANODE
2. ANODE
3. CATHODE



SC-70
CASE 419
STYLE 4

MARKING DIAGRAM

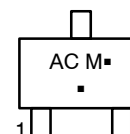

AC = Specific Device Code
M = Date Code
▪ = Pb-Free Package
(Note: Microdot may be in either location)

ORDERING INFORMATION

Device	Package	Shipping†
MMBZ27VCWT1G	SC-70 (Pb-Free)	3000/Tape & Reel

† For information on tape and reel specifications, including part orientation and tape sizes, please refer to our Tape and Reel Packaging Specifications Brochure, BRD8011/D.

MMBZ27VCWT1G

MAXIMUM RATINGS

Rating	Symbol	Value	Unit
Peak Power Dissipation @ 1.0 ms (Note 1) @ $T_L \leq 25^\circ\text{C}$	P_{pk}	40	Watts
Total Power Dissipation on FR-5 Board (Note 2) @ $T_A = 25^\circ\text{C}$ Derate above 25°C	P_D	200 1.6	mW mW/ $^\circ\text{C}$
Thermal Resistance Junction-to-Ambient	$R_{\theta JA}$	618	$^\circ\text{C}/\text{W}$
Junction and Storage Temperature Range	T_J, T_{stg}	- 55 to +150	$^\circ\text{C}$

Stresses exceeding Maximum Ratings may damage the device. Maximum Ratings are stress ratings only. Functional operation above the Recommended Operating Conditions is not implied. Extended exposure to stresses above the Recommended Operating Conditions may affect device reliability.

1. Nonrepetitive current pulse per Figure 4 and derate above $T_A = 25^\circ\text{C}$ per Figure 5.
2. FR-5 = 1.0 x 0.75 x 0.62 in.

ELECTRICAL CHARACTERISTICS

($T_A = 25^\circ\text{C}$ unless otherwise noted)

UNIDIRECTIONAL (Circuit tied to Pins 1 and 3 or 2 and 3)

Symbol	Parameter
I_{PP}	Maximum Reverse Peak Pulse Current
V_C	Clamping Voltage @ I_{PP}
V_{RWM}	Working Peak Reverse Voltage
I_R	Maximum Reverse Leakage Current @ V_{RWM}
V_{BR}	Breakdown Voltage @ I_T
I_T	Test Current
V_{BR}	Maximum Temperature Coefficient of V_{BR}
I_F	Forward Current
V_F	Forward Voltage @ I_F

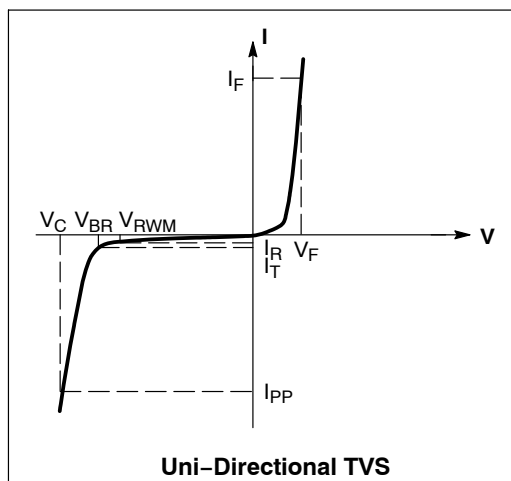

ELECTRICAL CHARACTERISTICS ($T_A = 25^\circ\text{C}$ unless otherwise noted)

UNIDIRECTIONAL (Circuit tied to Pins 1 and 3 or Pins 2 and 3)

($V_F = 1.1 \text{ V Max @ } I_F = 200 \text{ mA}$)

Device	Device Marking	V_{RWM} Volts	$I_R @ V_{RWM}$ nA	Breakdown Voltage			$V_C @ I_{PP}$ (Note 4)		V_{BR} mV/ $^\circ\text{C}$	
				V_{BR} (Note 3) (V)			V_C V	I_{PP} A		
				Min	Nom	Max				@ I_T mA
MMBZ27VCWT1G	AC	22	50	25.65	27	28.35	1.0	38	1.0	26

3. V_{BR} measured at pulse test current I_T at an ambient temperature of 25°C .
4. Surge current waveform per Figure 4 and derate per Figure 5

MMBZ27VCWT1G

TYPICAL CHARACTERISTICS

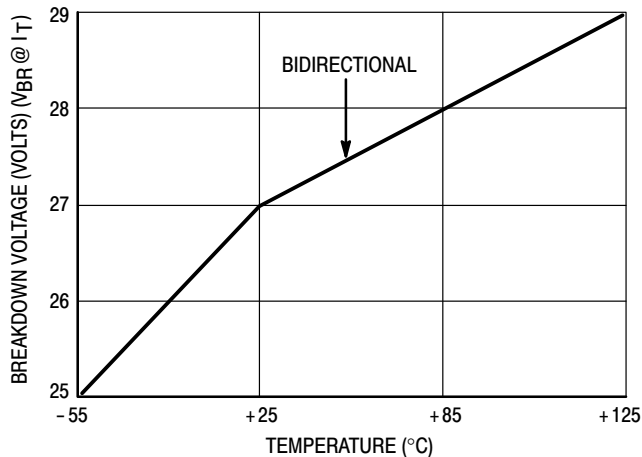

Figure 1. Typical Breakdown Voltage versus Temperature

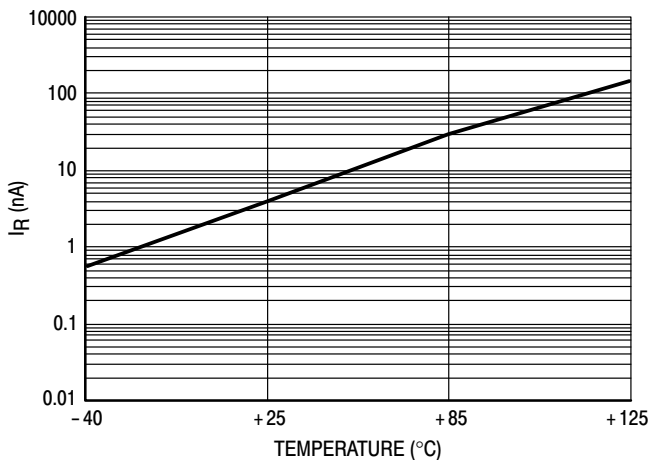

Figure 2. Typical Leakage Current versus Temperature

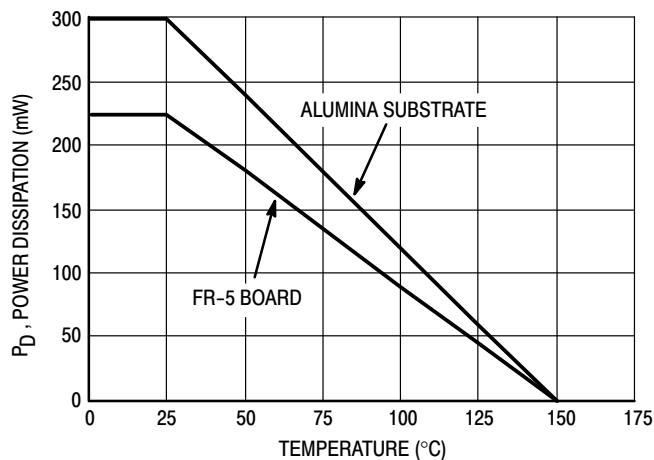

Figure 3. Steady State Power Derating Curve

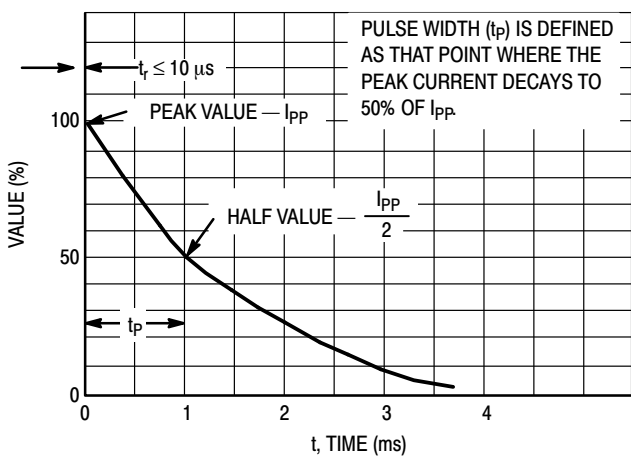

Figure 4. Pulse Waveform

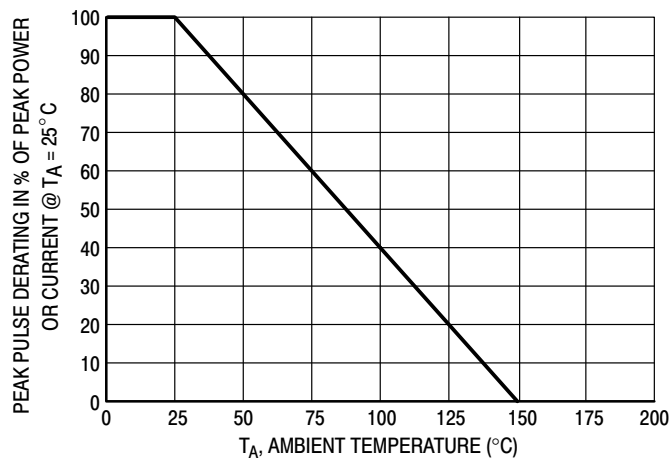
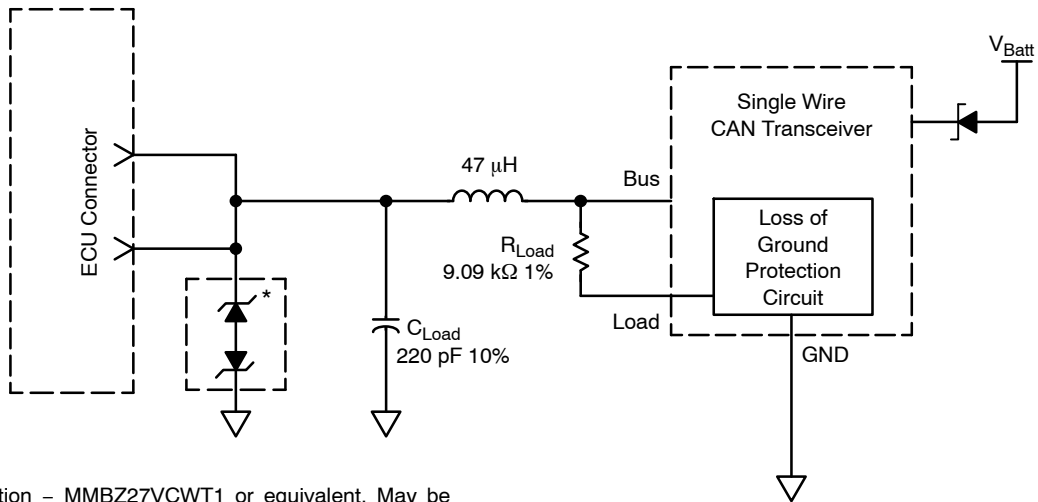

Figure 5. Pulse Derating Curve

MMBZ27VCWT1G

TYPICAL APPLICATIONS



*ESD Protection – MMBZ27VCWT1 or equivalent. May be located in each ECU (C_{Load} needs to be reduced accordingly) or at a central point near the DLC.

Figure 6. Single Wire CAN Network

Figure is the recommended solution for transient EMI/ESD protection. This circuit is shown in the Society of Automotive Engineers February, 2000 J2411 “Single Wire CAN Network for Vehicle Applications” specification (Figure 6, page 11). Note: the dual common anode zener configuration shown above is electrically equivalent to a dual common cathode zener configuration.

MMBZ27VCWT1G

PACKAGE DIMENSIONS

SC-70 (SOT-323)
CASE 419-04
ISSUE M

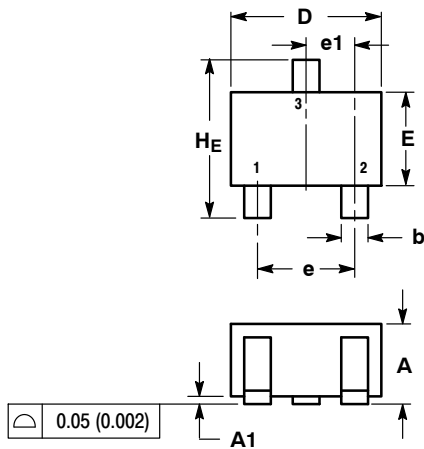

NOTES:

1. DIMENSIONING AND TOLERANCING PER ANSI Y14.5M, 1982.
2. CONTROLLING DIMENSION: INCH.

DIM	MILLIMETERS			INCHES		
	MIN	NOM	MAX	MIN	NOM	MAX
A	0.80	0.90	1.00	0.032	0.035	0.040
A1	0.00	0.05	0.10	0.000	0.002	0.004
A2	0.7 REF			0.028 REF		
b	0.30	0.35	0.40	0.012	0.014	0.016
c	0.10	0.18	0.25	0.004	0.007	0.010
D	1.80	2.10	2.20	0.071	0.083	0.087
E	1.15	1.24	1.35	0.045	0.049	0.053
e	1.20	1.30	1.40	0.047	0.051	0.055
e1	0.65 BSC			0.026 BSC		
L	0.425 REF			0.017 REF		
HE	2.00	2.10	2.40	0.079	0.083	0.095

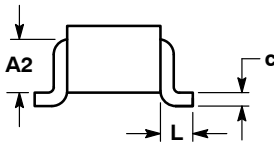

STYLE 4:

1. CATHODE
2. CATHODE
3. ANODE

SOLDERING FOOTPRINT*

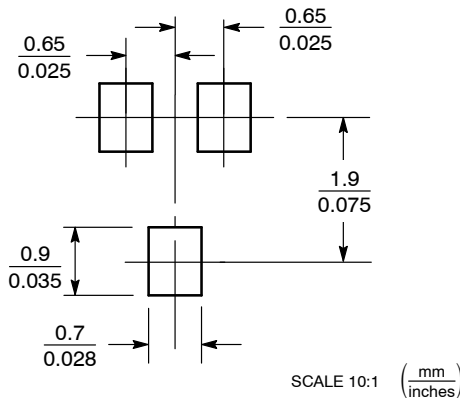

*For additional information on our Pb-Free strategy and soldering details, please download the ON Semiconductor Soldering and Mounting Techniques Reference Manual, SOLDERRM/D.

ON Semiconductor and are registered trademarks of Semiconductor Components Industries, LLC (SCILLC). SCILLC reserves the right to make changes without further notice to any products herein. SCILLC makes no warranty, representation or guarantee regarding the suitability of its products for any particular purpose, nor does SCILLC assume any liability arising out of the application or use of any product or circuit, and specifically disclaims any and all liability, including without limitation special, consequential or incidental damages. "Typical" parameters which may be provided in SCILLC data sheets and/or specifications can and do vary in different applications and actual performance may vary over time. All operating parameters, including "Typicals" must be validated for each customer application by customer's technical experts. SCILLC does not convey any license under its patent rights nor the rights of others. SCILLC products are not designed, intended, or authorized for use as components in systems intended for surgical implant into the body, or other applications intended to support or sustain life, or for any other application in which the failure of the SCILLC product could create a situation where personal injury or death may occur. Should Buyer purchase or use SCILLC products for any such unintended or unauthorized application, Buyer shall indemnify and hold SCILLC and its officers, employees, subsidiaries, affiliates, and distributors harmless against all claims, costs, damages, and expenses, and reasonable attorney fees arising out of, directly or indirectly, any claim of personal injury or death associated with such unintended or unauthorized use, even if such claim alleges that SCILLC was negligent regarding the design or manufacture of the part. SCILLC is an Equal Opportunity/Affirmative Action Employer. This literature is subject to all applicable copyright laws and is not for resale in any manner.

PUBLICATION ORDERING INFORMATION

LITERATURE FULFILLMENT:
Literature Distribution Center for ON Semiconductor
P.O. Box 5163, Denver, Colorado 80217 USA
Phone: 303-675-2175 or 800-344-3860 Toll Free USA/Canada
Fax: 303-675-2176 or 800-344-3867 Toll Free USA/Canada
Email: orderlit@onsemi.com

N. American Technical Support: 800-282-9855 Toll Free
USA/Canada
Europe, Middle East and Africa Technical Support:
Phone: 421 33 790 2910
Japan Customer Focus Center
Phone: 81-3-5773-3850

ON Semiconductor Website: www.onsemi.com

Order Literature: <http://www.onsemi.com/orderlit>

For additional information, please contact your local Sales Representative