



| | |
|-----------|------------|
| Spec. No. | PS-ND-0712 |
| Rev. | A |

PRODUCT SPECIFICATION

Model No : CSS-5160S/CSS-5161S

Descriptions:

- 0.50 Inch Single Digit Alphanumeric Display
- Emitting Color: Super-Bright Red



| CUSTOMER APPROVED | APPROVED BY | CHECKED BY | PREPARED BY |
|-------------------|-------------|------------|-------------|
| SIGNATURES | | | |
| | | | |

CHINA SEMICONDUCTOR CORPORATION

Address:2FL. NO.909,Chung-Cheng Road,
Chung-Ho City Taipei Hsien,Taiwan.

Tel:886-2-2223-9696
Fax:886-2-2223-9377

OPTO PLUS TECHNOLOGIES CO.,LTD

Address:696 Shun jiang Rd.,Ji Shan St.Shaoxing,
ZheJiang,China

Tel:86-0575-8623888
Fax:86-0575-8623112



| | |
|------------------|------------|
| Spec. No. | PS-ND-0712 |
| Rev. | A |

Model No : CSS-5160S/5161S

Features -

1. 0.50 inch (12.7 mm) digit height.
2. Case mold type.
3. RoHs compliant.
4. Low power consumption.
5. Easy mounting on P.C. board or socket.

Device Selection Guide -

| Part No. | Chip | | Description |
|------------------|---------------|-------------------------|-----------------------|
| | Material | Emitted Color | |
| CSS-5160S | AlGaAs | Super-Bright Red | Common Anode |
| CSS-5161S | | | Common Cathode |

Package Dimensions -

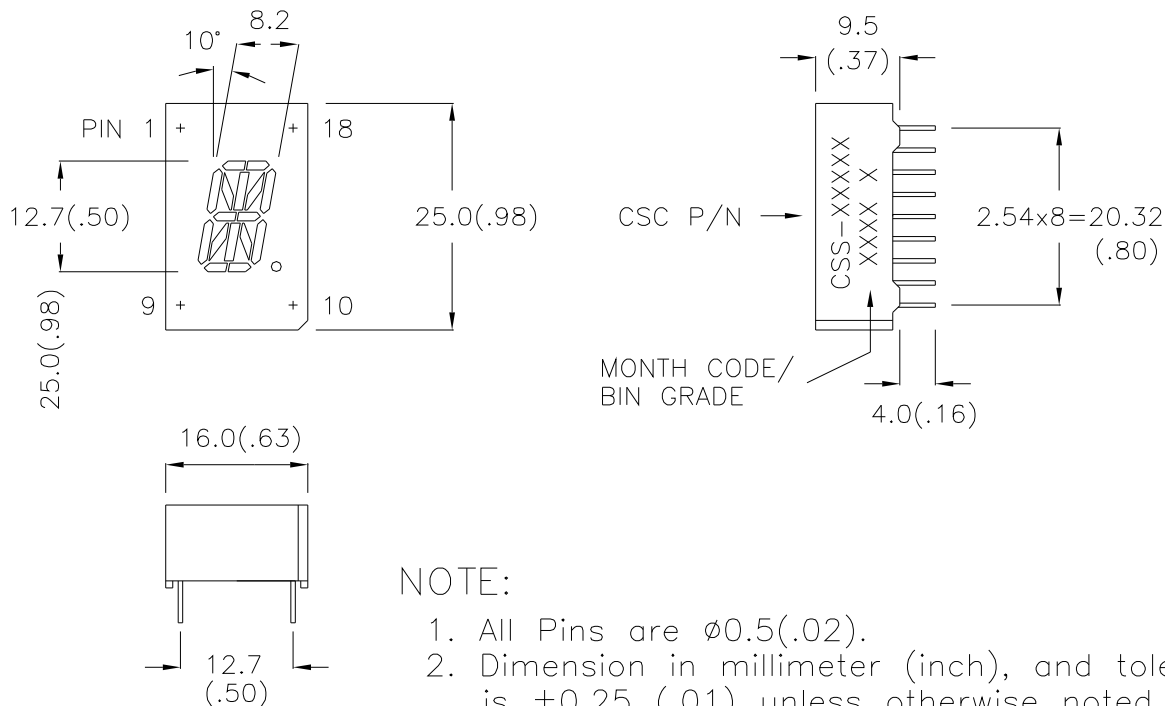

NOTE:

1. All Pins are $\phi 0.5(.02)$.
2. Dimension in millimeter (inch), and tolerance is $\pm 0.25 (.01)$ unless otherwise noted.



| | |
|------------------|------------|
| Spec. No. | PS-ND-0712 |
| Rev. | A |

Model No : CSS-5160S/5161S

■ **Internal Circuit Diagrams -**

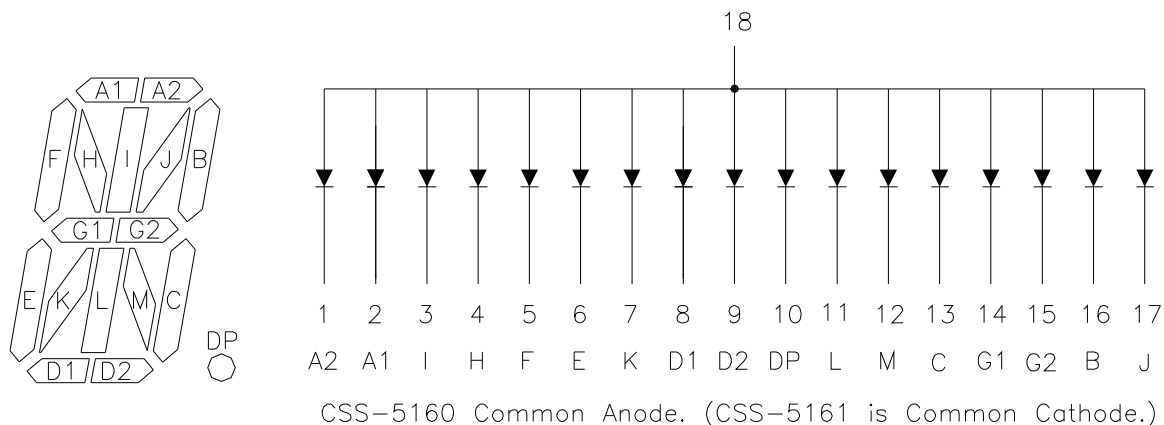

■ **Absolute Maximum Rating -**

(Ta=25°C)

| Parameter | Symbol | Rating | Unit |
|---|--------|-----------|-------|
| Power Dissipation Per Dice | Pd | 75 | mW |
| Continuous Forward Current Per Dice | IAF | 30 | mA |
| Peak Current Per Dice (duty cycle 1/10, 1kHz) | IPF | 125 | mA |
| Derating Linear From 25°C Per Dice | - | 0.42 | mA/°C |
| Reverse Voltage Per Dice | VR | 5 | V |
| Operating Temperature | Topr | -25 ~ +85 | °C |
| Storage Temperature | Tstg | -25 ~ +85 | °C |
| Solder temperature 1/16 inch below seating plane for 3 seconds at 260°C | | | |



| | |
|-----------|------------|
| Spec. No. | PS-ND-0712 |
| Rev. | A |

Model No : CSS-5160S/5161S

■ Electro-optical Characteristics -

(Ta=25°C)

| Parameter | Symbol | Min. | Typ. | Max. | Unit | Condition |
|-----------------------------------|------------------|------|------|-------|---------|-----------|
| Forward Voltage Per Segment | VF | - | 1.8 | 2.5 | V | IF=20mA |
| Luminous Intensity Per Segment | Iv | - | 5 | - | mcd | IF=10mA |
| Peak Emission Wavelength | λ_p | - | 660 | - | nm | IF=20mA |
| Spectrum Radiation Bandwidth | $\Delta \lambda$ | - | 20 | - | nm | IF=20mA |
| Reverse Current | IR | - | - | 100 | μA | VR=5V |
| Luminous Intensity Matching Ratio | IV-m | - | - | 2 : 1 | - | IF=20mA |



| | |
|-----------|------------|
| Spec. No. | PS-ND-0712 |
| Rev. | A |

Model No : CSS-5160S/5161S

Typical Electrical / Optical Characteristics Curves -

(Ta = 25°C Unless Otherwise Noted)

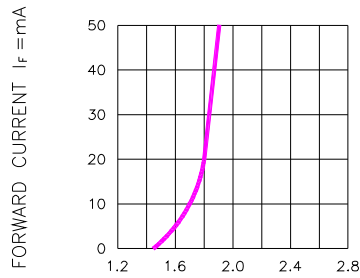

Fig.1 FORWARD CURRENT VS. FORWARD VOLTAGE

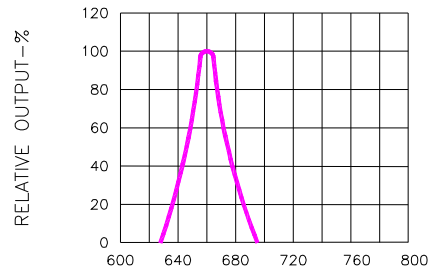

Fig.2 SPECTRAL RESPONSE

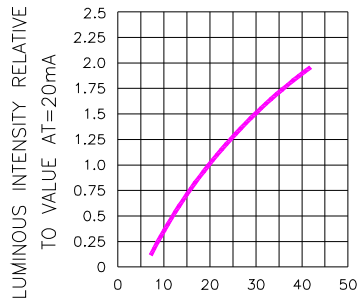

Fig.3 RELATIVE LUMINOUS INTENSITY VS. FORWARD CURRENT

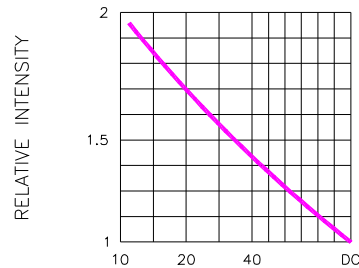

Fig.5 LUMINOUS INTENSITY VS. DUTY CYCLE

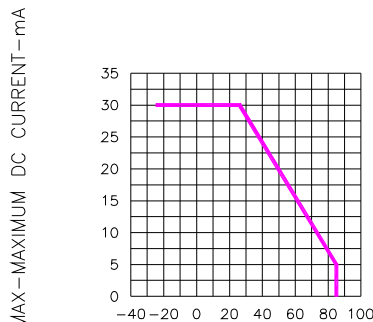

Fig.4 MAXIMUM ALLOWABLE DC CURRENT PER SEGMENT VS. A FUNCTION OF AMBIENT TEMPERATURE

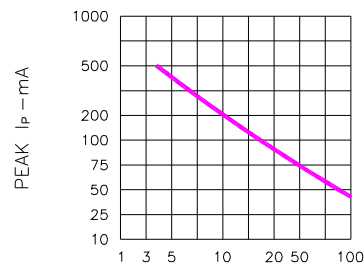

Fig.6 MAX PEAK CURRENT VS. DUTY CYCLE % (REFRESH RATE f=1 KHz)



| | |
|-----------|------------|
| Spec. No. | PS-ND-0712 |
| Rev. | A |

Model No : CSS-5160S/5161S

■ Package Dimensions

Single Digit Display
Dice Code
CSS-516XS

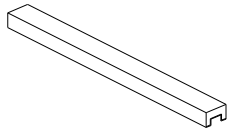

1 TUBE From Box = 20 PCS

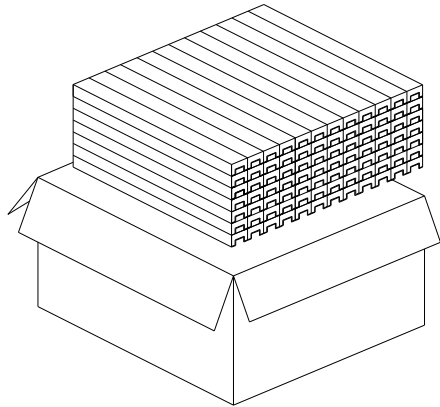

1 BOX= 60 TUBE From Box
Q'TY: 1200 PCS.



1 CARTON = 3 BOX.
Q'TY: 3600 PCS.

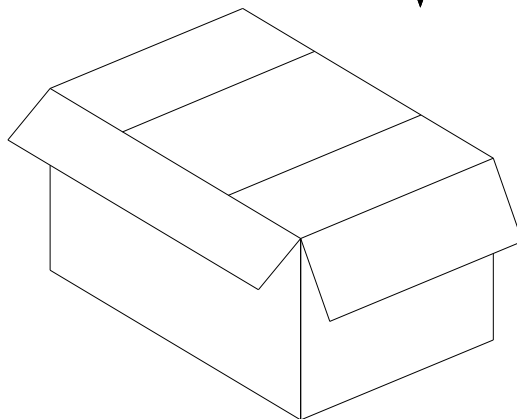

Carton Size:
L540 x W485 x 305 mm

Note: The specifications are subject to change without notice. Please contact us for updated information.