

SPECIFICATION FOR APPROVAL

REF : 20091021-C

PAGE: 1

PROD. NAME	SMD POWER INDUCTOR	ABC'S DWG NO.	SR3015□□□□L□-□□□
		ABC'S ITEM NO.	

I . CONFIGURATION & DIMENSIONS :

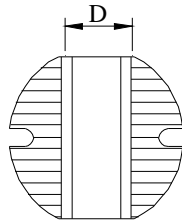
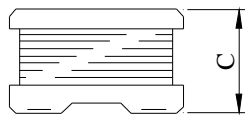
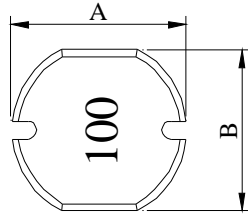

- A : 3.0 ±0.2 m/m
- B : 2.8 ±0.2 m/m
- C : 1.5 ±0.2 m/m
- D : 0.9 typ. m/m
- G : 0.8 ref. m/m
- H : 3.0 ref. m/m
- I : 1.4 ref. m/m

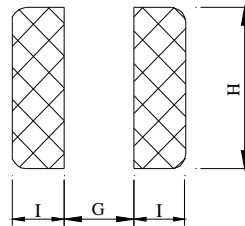

(PCB Pattern)

II . SCHEMATIC DIAGRAM :

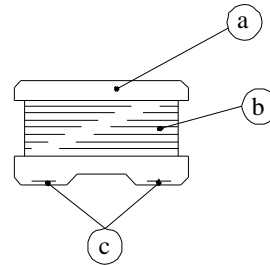
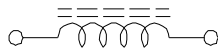

III . MATERIALS :

- a . Core : Ferrite DR core
- b . Wire : Enamelled copper wire (class F & H)
- c . Terminal : Ag/Ni/Sn
- d . Remark : Products comply with RoHS' requirements

Peak Temp : 260°C max.
 Max time above 230°C : 50sec max.
 Max time above 200°C : 70sec max.

IV . GENERAL SPECIFICATION :

- a . Temp. rise : 30°C max.
- b . Rated current : Base on temp. rise
& $\Delta L / LOA = 10\%$ typ.
- c . Storage temp. : -40°C ---- +125°C
- d . Operating temp. : -40°C ---- +105°C
- e . Resistance to solder heat : 260°C.10 secs.

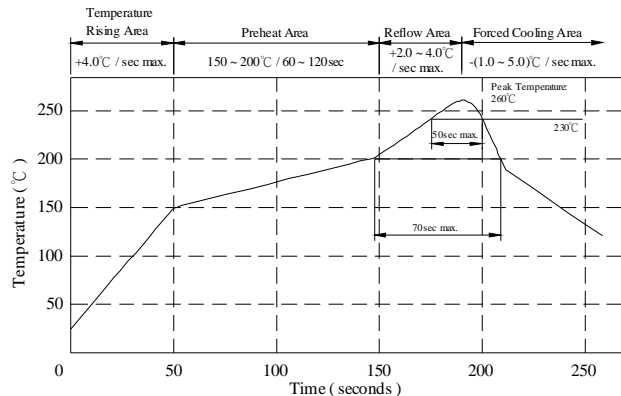

AR-001A

SPECIFICATION FOR APPROVAL

REF : 20091021-C

PAGE: 2

PROD. NAME	SMD POWER INDUCTOR	ABC'S DWG NO.	SR3015□□□□L□-□□□
		ABC'S ITEM NO.	

V . ELECTRICAL CHARACTERISTICS :

DWG No.	Inductance (μ H)	Q ref.	Test Freq.		RDC (Ω)		SRF (MHz) typ.	Isat (mA) typ.	Irms (mA) max.
			L (Hz)/0.1V	Q (MHz)	typ.	max.			
SR30152R2ML□-□□□	2.2 \pm 20 %	12.0	100K	7.96	0.095	0.125	100	1000	1200
SR30154R7ML□-□□□	4.7 \pm 20 %	10.0	100K	7.96	0.165	0.215	80	700	1000
SR3015100ML□-□□□	10.0 \pm 20 %	12.0	100K	2.52	0.360	0.450	55	500	650
SR3015150ML□-□□□	15.0 \pm 20 %	15.0	100K	2.52	0.540	0.675	40	400	500
SR3015220ML□-□□□	22.0 \pm 20 %	20.0	100K	2.52	0.850	1.060	35	330	420
SR3015330KL□-□□□	33.0 \pm 10 %	20.0	100K	2.52	1.150	1.430	28	270	350
SR3015470KL□-□□□	47.0 \pm 10 %	15.0	100K	2.52	1.550	1.950	23	220	300
SR3015680KL□-□□□	68.0 \pm 10 %	22.0	100K	2.52	2.350	2.950	18	180	230
SR3015101KL□-□□□	100.0 \pm 10 %	40.0	100K	0.796	3.500	4.400	15	160	200

- 1) . □ : Packaging Information... [A] : Bulk [B] : Taping Reel
- 2) . "- □□□" : Reference code
- 3) . Inductance Test Freq. : 100KHz / 0.1V
- 4) . Isat base on $\Delta L / L0A = 10\%$ typ.
- 5) . Irms base on Temp. rise 30°C max.

Inductance VS. DC Current curve

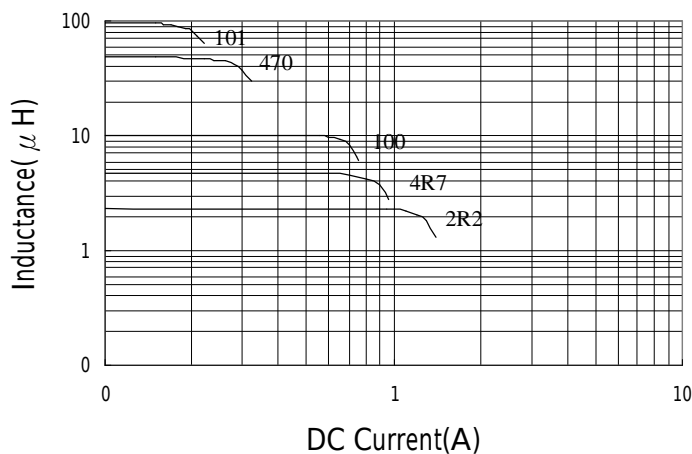

SPECIFICATION FOR APPROVAL

REF : 20091021-C

PAGE: 3

PROD. NAME	SMD POWER INDUCTOR	ABC'S DWG NO.	SR3015□□□□L□-□□□
		ABC'S ITEM NO.	

VI . PACKAGING INFORMATION

(1) Configuration

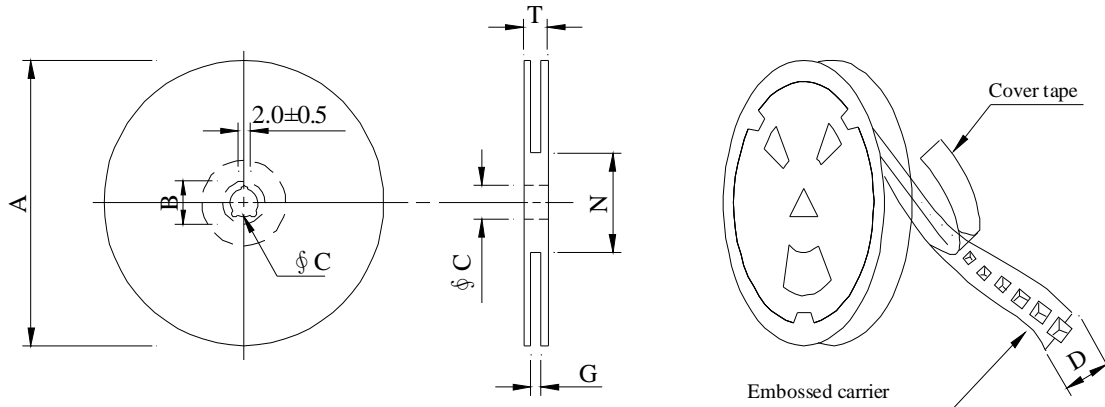

※Carrier tape width : D

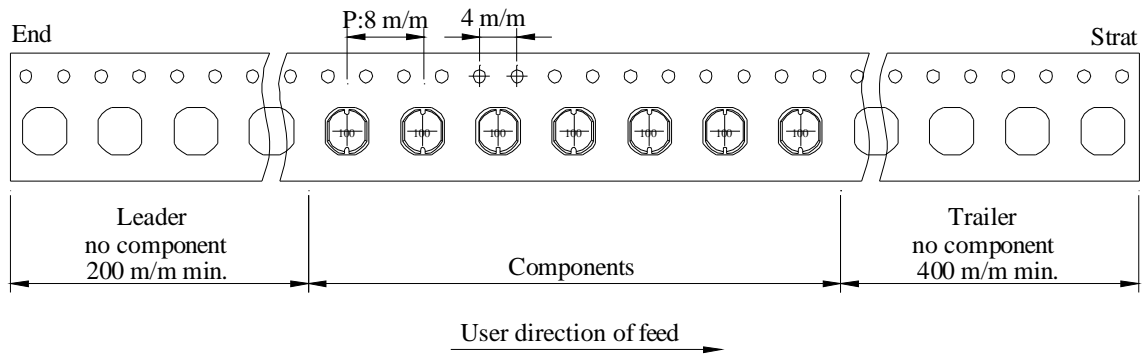

(2) Dimensions

Unit:m/m

Style	A	B	C	D	G	N	T
07 - 12	178	21±0.8	13	12	14 ⁺⁰	50 ⁻⁰	16.5

(3) Q'TY & G.W. Per package

Series	Inner : Reel			Outer : Carton		
	Q'TY (pcs)	G.W. (gw)	Style	Q'TY (pcs)	G.W. (Kg)	Size (cm)
SR3015	1200	300	07 - 12	48,000	10.5	42 x 41 x 24

AR-001A

SPECIFICATION FOR APPROVAL

REF : 20091021-C

PAGE: 4

PROD. NAME	SMD POWER INDUCTOR	ABC'S DWG NO.	SR3015□□□□L□-□□□
		ABC'S ITEM NO.	

VII . DWGING NUMBER EXPRESSION :

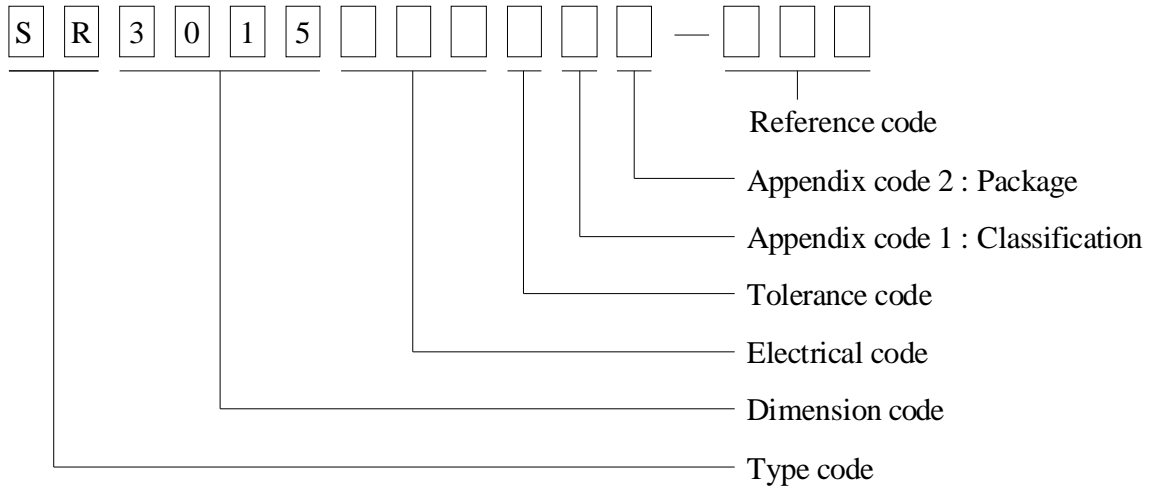

Appendix code 1 : Product Classification

- L : Lead Free Standard products comply with RoHS' requirements
- 1 ~ 9 : Lead Free Special products comply with RoHS' requirements

Appendix code 2 : Package Information

Code	Inner package	Inner package QTY	Remark
A	T.B.D.	T.B.D.	
B	T / R (Reel package)	1,200 pcs	

SPECIFICATION FOR APPROVAL

REF : 20091021-C

PAGE: 5

PROD. NAME	SMD POWER INDUCTOR	ABC'S DWG NO.	SR3015□□□□L□-□□□
		ABC'S ITEM NO.	

VIII . RELIABILITY TEST :

Test item	Specification	Test condition						
Solderability	More than 95% of the terminal electrode shall be covered With fresh solder.	Preheat : 155°C / 4 hours. Solder : Sn96.5 / Ag3 / Cu0.5 or equivalent Solder temp. : 235±5°C Flux : Rosin Dip time : 5±0.5 seconds						
Thermal shock test (Temp. cycle)	Electrical oharacteristics shall not change more than ±20%	<table style="width: 100%; border: none;"> <tr> <td style="text-align: center;">Room temp. 15 minutes</td> <td style="text-align: center; vertical-align: middle;">→</td> <td style="text-align: center;">-40 °C 30 minutes</td> </tr> <tr> <td style="text-align: center;">Room temp. 15 minutes</td> <td style="text-align: center; vertical-align: middle;">→</td> <td style="text-align: center;">+105 °C 30 minutes</td> </tr> </table> <p>Total : 50 cycles</p>	Room temp. 15 minutes	→	-40 °C 30 minutes	Room temp. 15 minutes	→	+105 °C 30 minutes
Room temp. 15 minutes	→	-40 °C 30 minutes						
Room temp. 15 minutes	→	+105 °C 30 minutes						
Humidity test		Temperature : 40±2°C Humidity : 90±5% Time : 1000 hours						
High temp. Resistance test		Temperature : 105±5°C Applied current : Per spec. Time : 96 hours						

SPECIFICATION FOR APPROVAL

REF : 20091021-C

PAGE: 6

PROD. NAME	SMD POWER INDUCTOR	ABC'S DWG NO.	SR3015□□□□L□-□□□
		ABC'S ITEM NO.	

IX . UL CARD :

OBMW2 September 8, 2000
 Magnet Wire-Component

JUNG SHING WIRE CO LTD E174837
 231 CHUNG CHENG RD, SEC 3 JEN-TEH HSIANG, TAINAN
 HSIEN TAIWAN

Mtl Dsg	Mark Dsg	Coat Typ		ANSI Type	Temp Class
		BC	OC		
AIW	---	Polyamideimide	---	MW81-C	220
CFUEWB	---	Polyurethane	---	MW75C	130
EIAIW	---	Polyesterimide	Polyamideimide	MW35C	200
EILOCKY	---	Polyesterimide	Polyamide	---	180
EILOCKW	---	Polyesterimide	Modified Epoxy	---	200
EIW	---	Polyesterimide	---	---	220
EIW-2	---	Polyesterimide	---	MW74-C	200
FLIELOCKY	---	Modified Polyester	Polyamide	---	155
LSFFW	---	Polyurethane	---	MW79-C	155
LSUEW	---	Polyurethane	---	---	130
PEW	---	Polyester	---	---	155
PEY	---	Polyester	Nylon	MW24-C	155
SF.FLW	---	Modified Polyester	---	MW26C	155
SF.EIW	---	Polyesterimide	---	MW77C	180
SF.BY@	---	Modified Polyester	Nylon	MW27-C	155
SF.FLY@	---	Modified Polyester	Nylon	MW27-C	155
SF.BLOCKBS	---	Modified Polyester	Modified Polyamide	---	155
SF.EILOCKY#	---	Polyesterimide	Polyamide	---	180
SF.EILOCKBS	---	Polyesterimide	Modified Polyamide	---	180
SF.BW@	---	Modified Polyester	---	MW26C	155
SFFW	---	Polyurethane	---	MW79	155

A not-for-profit organization
dedicated to public safety and
committed to quality service

287806002 Page 1 of 2

Mtl Dsg	Mark Dsg	Coat Typ		ANSI Type	Temp Class
		BC	OC		
SFFY	---	Polyurethane	Polyamide	MW80C	155
UEW-1	---	Polyurethane	---	MW2-C	105
UEW-2	---	Polyurethane	---	---	130
UEW-4	---	Polyurethane	---	MW75C	130
UEY	---	Polyurethane	Nylon	MW28-C	130
UEY-2	---	Polyurethane	Polyamide	MW28-C	130

@-May be suffixed by LZ; # - May be suffixed by LZ, EL or LZI.
 LZ - Signifies magnd wires twisted together; EL - signifies base coated magnet wire laid parallel with top coat applied overall; LZL - signi-
 fies base coated magnet wire twisted together and covered with top coat overall.

Marking: Company name or trademarks **JSW** or 榮星電線 , material designation or marked designation on packaed or reel, and
 Recognized Component Mark.

See General Information Preceding These Recognitions
 For use only in equipment where the acceptability of the combination is determined by Underwriters Laboratories Inc.

287806002 Page 2 of 2 OBMW2E174837
September 8 , 2000

SPECIFICATION FOR APPROVAL

REF : 20091021-C

PAGE: 7

PROD. NAME	SHIELDED SMD POWER INDUCTOR	ABC'S DWG NO. ABC'S ITEM NO.	SR3015□□□□L□-□□□
---------------	--------------------------------	---------------------------------	------------------

OBMW2 October 06, 2005

Magnet Wire-Component

ELEKTRISOLA (MALAYSLA) SDN BHD E143312

JALAN DAMAI SATU JANDA BAIK 28750 BENTONG, PAHANG
DARUL MAKMUR MALAYSIA

Mtl Dsg	Mark Dsg	Coating Type		ANSI Typ	Temp Class
		BC	OC		
Estersol 180	E180	Polyesterimide (solderable)	—	MW-77	180
Amldester 200	A200	Polyesterimide	—	MW-74	200
Polysol-N 155	PN155	Polyurethane	Nylon	MW-80, MW-28	155, 130
Polysol 155	P155, G155	Polyurethane	—	MW-79, MW-75	155, 130
Polysol 155g	Pg155	Polyurethane	—	MW-75	130
Polysol 155p	Pp155,Gp155	Polyurethane	—	MW-79	155
Polysol 160	P160	Polyurethane	—	MW-79	155
Polysol 180	P180,G180	Polyurethane	—	MW-82, MW-79	180, 155
Polysol 170	P170 or G170	Polyurethane	—	MW-79	155
Polysol-N 180	PN180	Polyurethane	Nylon	MW-83	180
Polysol P155p	P155p	Polyurethane	—	MW-79	155

Marking : Company name, material designation or marked designation and factory identification on package ok reel

See General Information preceding These Recognitions

For use only in equipment where the acceptability of the combination is determined by Underwriters Laboratories Inc.

AR-001A

