

P-tec Corp. Tel:(800)688-0613
 2405 Commerce Circle Tel:(719) 589 3122
 Alamosa Co. 81101 Fax:(719) 589 3592
 www.p-tec.net sales@p-tec.net



PL0055 Series SMD LED PLCC-6 Package

Features

- *Flat Lens Package 5.0 x 5.0 x 1.8mm
- *6 InGaN Ultra Bright White Chips used
- *Very High Luminous Output
- *Wide Viewing Angle
- *1000 pc reels, 12mm Tape
- *Integrated Zener Diode for ESD protection
- *RoHS Compliant

Absolute Maximum Ratings at T_A = 25°C

Power Dissipation.....	120mW
Reverse Voltage (<100μA).....	5.0V
Max Forward Current.....	30mA
Peak Forward Current (1/10 Duty Cycle, 0.1ms Pulse Width).....	100mA
Operating Temperature Range.....	-25°C to +85°C
Storage Temperature Range.....	-40°C to +100°C
Reflow Soldering Temperature.....	260°C for 10 seconds
Electric Static Discharge Threshold (HBM).....	6000V

Electrical & Optical Characteristics at T_A = 25°C

Part Number	Emitting Color	Chip Material	Chromaticity Coordinates Typ		Viewing Angle 2θ ½ Deg	Forward Voltage @40mA (V)		Luminous Intensity @40mA (mcd)		Luminous Flux @40mA (mlm) Typ
			X	Y		Typ	Max	Min	Max	
PL0055-WC6W24Z	White	InGaN	0.31	0.30	120°	3.2	4.0	4800	7000	15000

Package Dimensions are in **Millimeters**. Tolerance is ± 0.25mm unless otherwise specified.

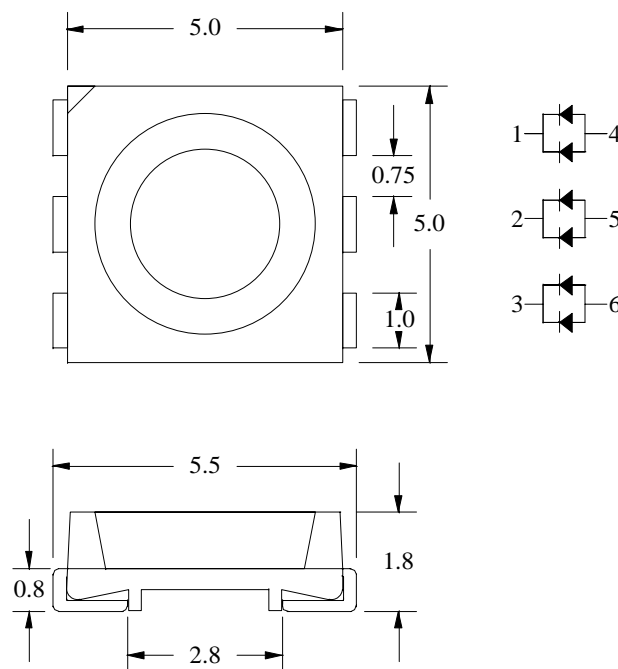

Recommended Soldering Pad Layout

