



SEMiX[®]2s

Trench IGBT Modules

SEMiX402GB066HDs

Preliminary Data

Features

- Homogeneous Si
- Trench = Trenchgate technology
- $V_{CE(sat)}$ with positive temperature coefficient
- UL recognised file no. E63532

Typical Applications

- Matrix Converter
- Resonant Inverter
- Current Source Inverter

Remarks

- Case temperature limited to $T_C=125^\circ\text{C}$ max.
- Product reliability results are valid for $T_j=150^\circ\text{C}$
- For short circuit: Soft R_{Goff} recommended
- Take care of over-voltage caused by stray inductance

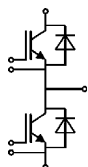

GB

Absolute Maximum Ratings

Symbol	Conditions	Values	Unit	
IGBT				
V_{CES}		600	V	
I_C	$T_j = 175^\circ\text{C}$	$T_c = 25^\circ\text{C}$	509	A
		$T_c = 80^\circ\text{C}$	383	A
I_{Cnom}		400	A	
I_{CRM}	$I_{CRM} = 2 \times I_{Cnom}$	800	A	
V_{GES}		-20 ... 20	V	
t_{psc}	$V_{CC} = 360\text{ V}$	6	μs	
	$V_{GE} \leq 15\text{ V}$			
	$T_j = 150^\circ\text{C}$			
	$V_{CES} \leq 600\text{ V}$			
T_j		-40 ... 175	$^\circ\text{C}$	
Inverse diode				
I_F	$T_j = 175^\circ\text{C}$	$T_c = 25^\circ\text{C}$	543	A
		$T_c = 80^\circ\text{C}$	397	A
I_{Fnom}		400	A	
I_{FRM}	$I_{FRM} = 2 \times I_{Fnom}$	800	A	
I_{FSM}	$t_p = 10\text{ ms, sin } 180^\circ, T_j = 25^\circ\text{C}$	1800	A	
T_j		-40 ... 175	$^\circ\text{C}$	
Module				
$I_{t(RMS)}$		600	A	
T_{stg}		-40 ... 125	$^\circ\text{C}$	
V_{isol}	AC sinus 50Hz, $t = 1\text{ min}$	4000	V	

Characteristics

Symbol	Conditions	min.	typ.	max.	Unit
IGBT					
$V_{CE(sat)}$	$I_C = 400\text{ A}$ $V_{GE} = 15\text{ V}$ chipelevel	$T_j = 25^\circ\text{C}$	1.45	1.9	V
		$T_j = 150^\circ\text{C}$	1.70	2.1	V
V_{CE0}		$T_j = 25^\circ\text{C}$	0.9	1	V
		$T_j = 150^\circ\text{C}$	0.85	0.9	V
r_{CE}	$V_{GE} = 15\text{ V}$	$T_j = 25^\circ\text{C}$	1.4	2.3	$\text{m}\Omega$
		$T_j = 150^\circ\text{C}$	2.1	3.0	$\text{m}\Omega$
$V_{GE(th)}$	$V_{GE}=V_{CE}, I_C = 6.4\text{ mA}$	5	5.8	6.5	V
I_{CES}	$V_{GE} = 0\text{ V}$ $V_{CE} = 600\text{ V}$	$T_j = 25^\circ\text{C}$	0.15	0.45	mA
		$T_j = 150^\circ\text{C}$			mA
C_{ies}	$V_{CE} = 25\text{ V}$ $V_{GE} = 0\text{ V}$	$f = 1\text{ MHz}$	24.7		nF
C_{oes}		$f = 1\text{ MHz}$	1.54		nF
C_{res}		$f = 1\text{ MHz}$	0.73		nF
Q_G	$V_{GE} = -8\text{ V...} + 15\text{ V}$		3200		nC
R_{Gint}	$T_j = 25^\circ\text{C}$		1.00		Ω
$t_{d(on)}$	$V_{CC} = 300\text{ V}$		150		ns
t_r	$I_C = 400\text{ A}$		125		ns
E_{on}	$T_j = 150^\circ\text{C}$		22		mJ
$t_{d(off)}$	$R_{G on} = 4.5\ \Omega$ $R_{G off} = 4.5\ \Omega$		900		ns
					ns
t_f			65		ns
E_{off}			24		mJ
$R_{th(j-c)}$	per IGBT			0.12	K/W
$R_{th(j-s)}$	per IGBT				K/W



SEMiX[®]2s

Trench IGBT Modules

SEMiX402GB066HDs

Preliminary Data

Features

- Homogeneous Si
- Trench = Trenchgate technology
- $V_{CE(sat)}$ with positive temperature coefficient
- UL recognised file no. E63532

Typical Applications

- Matrix Converter
- Resonant Inverter
- Current Source Inverter

Remarks

- Case temperature limited to $T_C=125^\circ\text{C}$ max.
- Product reliability results are valid for $T_j=150^\circ\text{C}$
- For short circuit: Soft R_{Goff} recommended
- Take care of over-voltage caused by stray inductance

Characteristics						
Symbol	Conditions		min.	typ.	max.	Unit
Inverse diode						
$V_F = V_{EC}$	$I_F = 400\text{ A}$ $V_{GE} = 0\text{ V}$ chipelevel	$T_j = 25^\circ\text{C}$		1.4	1.6	V
		$T_j = 150^\circ\text{C}$		1.4	1.6	V
V_{F0}		$T_j = 25^\circ\text{C}$	0.9	1	1.1	V
		$T_j = 150^\circ\text{C}$	0.75	0.85	0.95	V
r_F		$T_j = 25^\circ\text{C}$	0.8	1.0	1.3	m Ω
		$T_j = 150^\circ\text{C}$	1.1	1.4	1.6	m Ω
I_{RRM}	$I_F = 400\text{ A}$ $di/dt_{off} = 3700\text{ A}/\mu\text{s}$ $V_{GE} = -8\text{ V}$ $V_{CC} = 300\text{ V}$	$T_j = 150^\circ\text{C}$		250		A
Q_{rr}		$T_j = 150^\circ\text{C}$		47		μC
E_{rr}		$T_j = 150^\circ\text{C}$			10	
$R_{th(j-c)}$	per diode				0.15	K/W
$R_{th(j-s)}$	per diode					K/W
Module						
L_{CE}				18		nH
$R_{CC+EE'}$	res., terminal-chip	$T_C = 25^\circ\text{C}$		0.7		m Ω
		$T_C = 125^\circ\text{C}$		1		m Ω
$R_{th(c-s)}$	per module			0.045		K/W
M_s	to heat sink (M5)		3		5	Nm
M_t		to terminals (M6)	2.5		5	Nm
						Nm
w					250	g
Temperature sensor						
R_{100}	$T_C=100^\circ\text{C}$ ($R_{25}=5\text{ k}\Omega$)			0,493 $\pm 5\%$		k Ω
$B_{100/125}$	$R_{(T)}=R_{100}\exp[B_{100/125}(1/T-1/T_{100})]$; $T[\text{K}]$;			3550 $\pm 2\%$		K

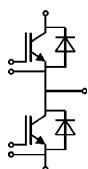

GB

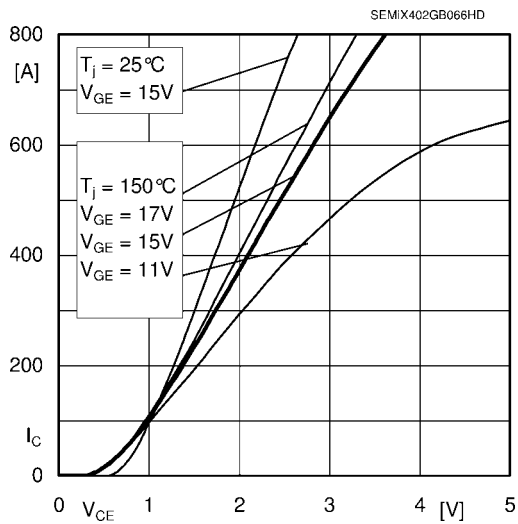

Fig. 1 Typ. output characteristic, inclusive $R_{CC'+EE'}$

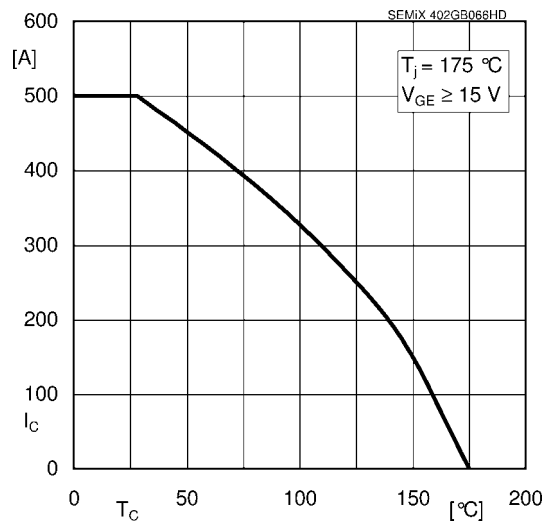

Fig. 2 Rated current vs. temperature $I_C = f(T_C)$

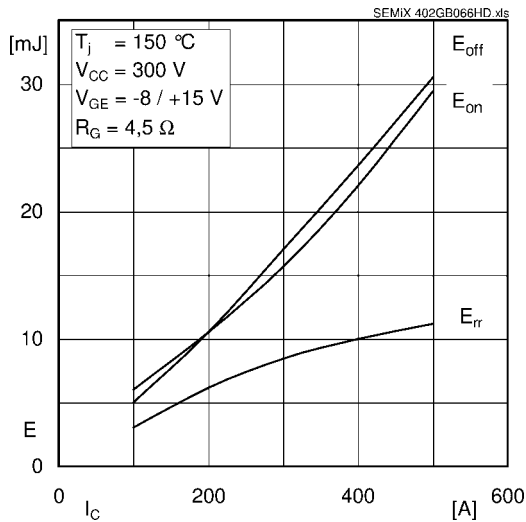

Fig. 3 Typ. turn-on /-off energy = $f(I_C)$

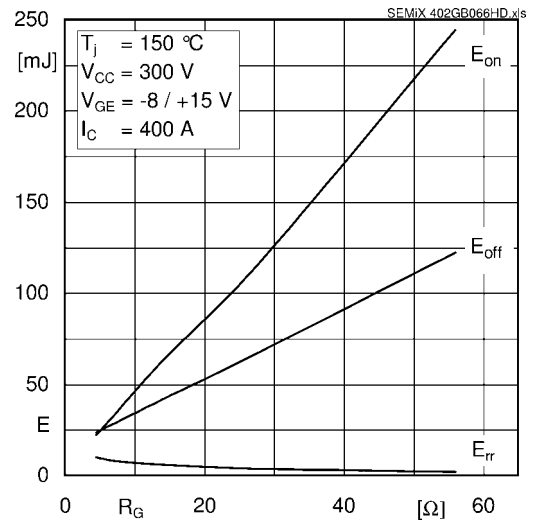

Fig. 4 Typ. turn-on /-off energy = $f(R_G)$

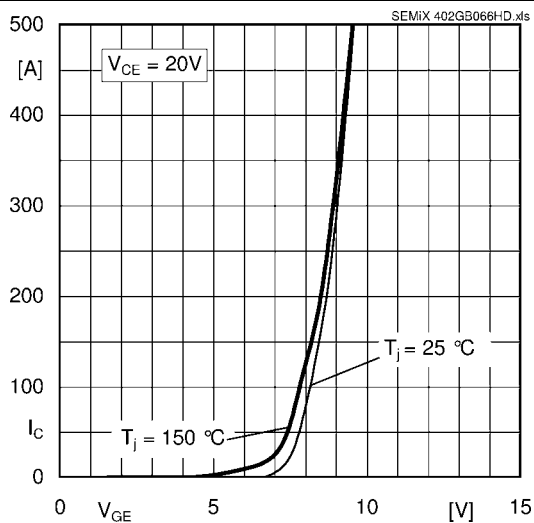

Fig. 5 Typ. transfer characteristic

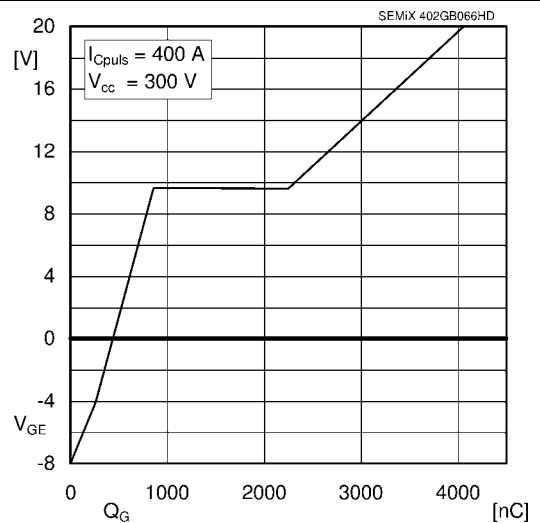
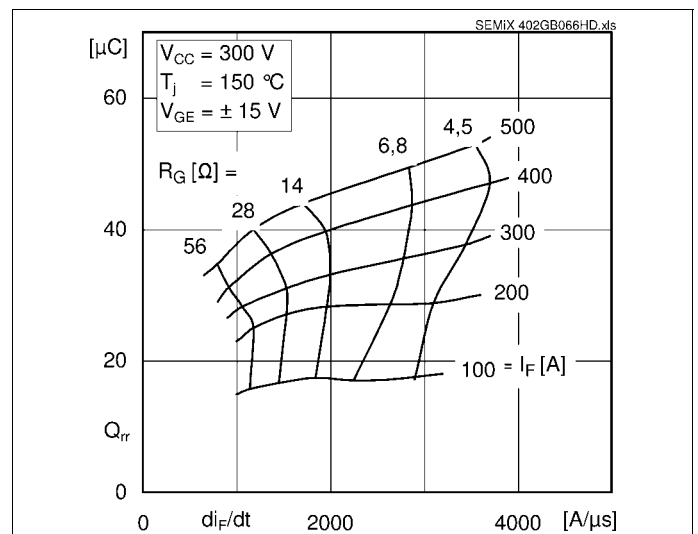
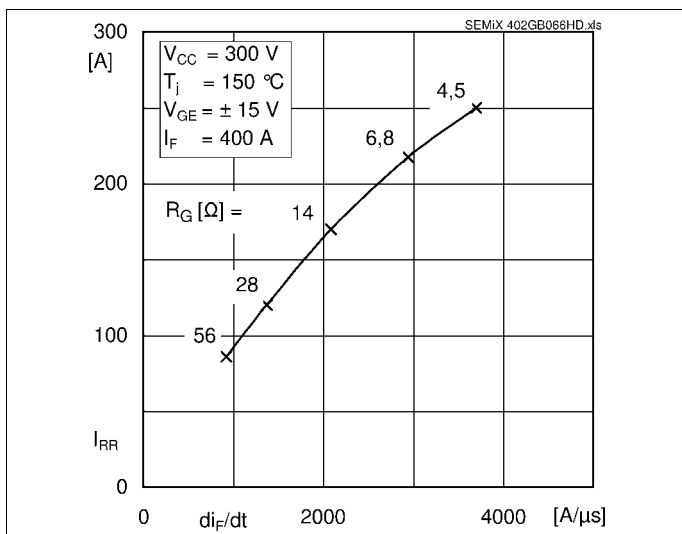
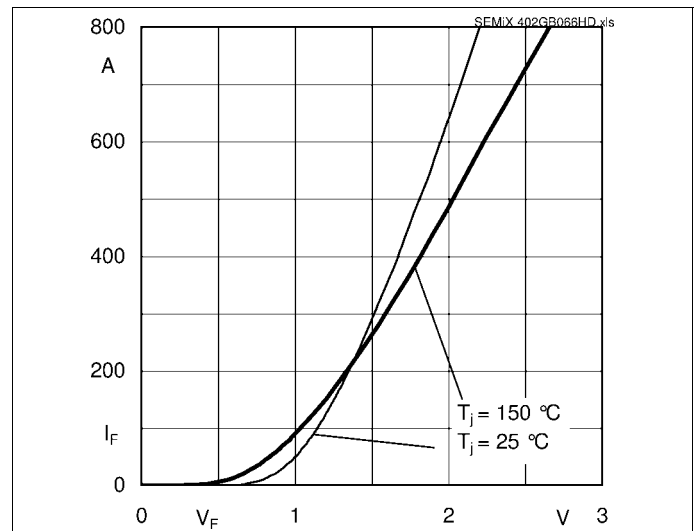
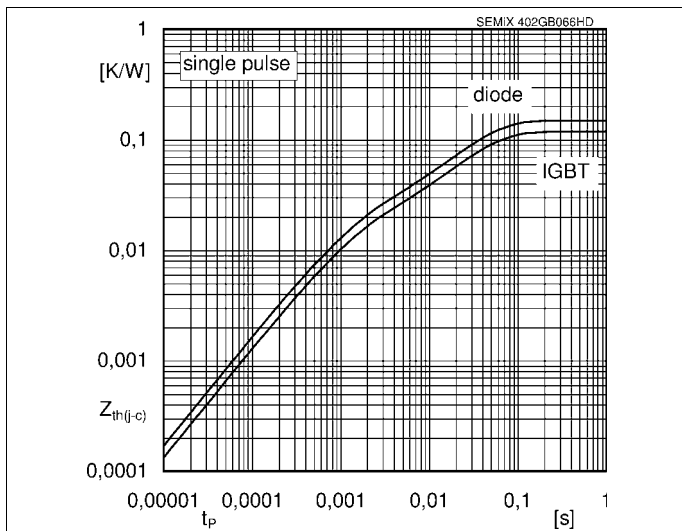
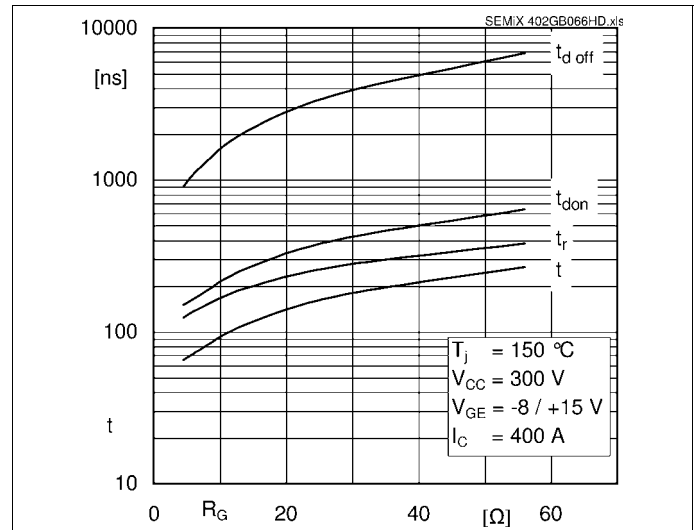
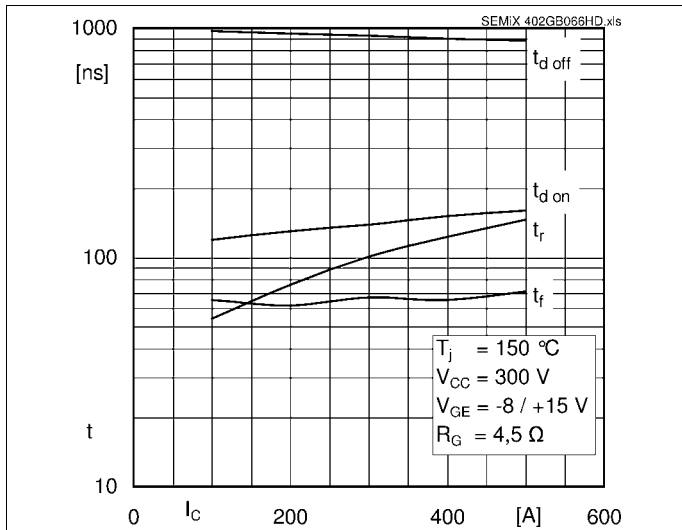

Fig. 6 Typ. gate charge characteristic



SEMiX402GB066HDs

case: SEMiX 2s

screw duct (4x):
A-A (2 : 1)

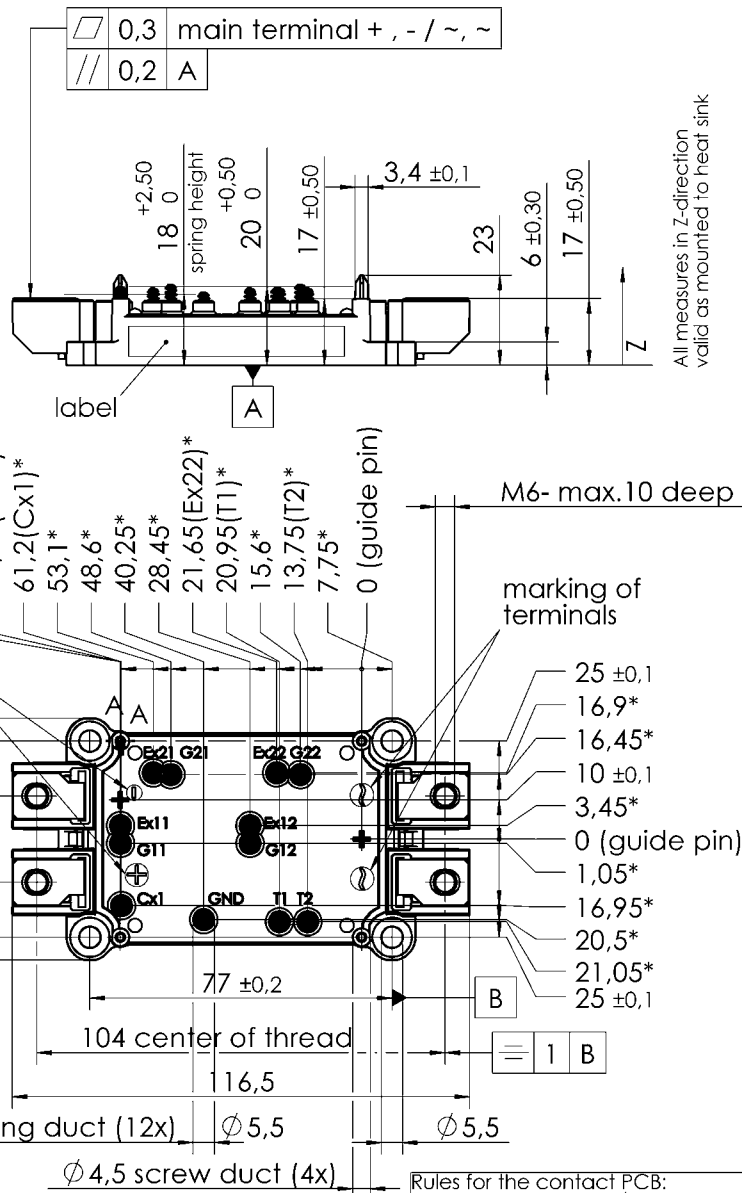
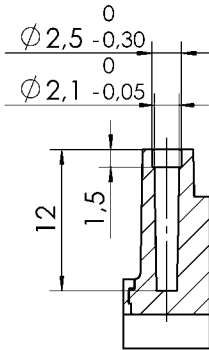

All measures in Z-direction valid as mounted to heat sink

* all measures with $\pm 0,2$ B C

Rules for the contact PCB:
- holes guidepins = $\varnothing 4 \pm 0,1$
- spring landing pad = $\varnothing 3,5 \pm 0,2$

SEMiX 2s

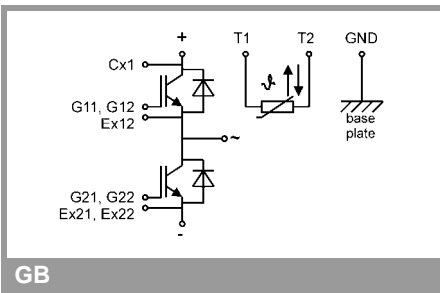

This is an electrostatic discharge sensitive device (ESDS), international standard IEC 60747-1, Chapter IX

This technical information specifies semiconductor devices but promises no characteristics. No warranty or guarantee expressed or implied is made regarding delivery, performance or suitability.