

Part Number	Description
EPC24N10A	10A, 265 Vac
EPC24N40A	40A, 265 Vac
EPC24N40R	40A, 265 Vac
EPC46N70A	70A, 460 Vac
EPC46N110A	110A, 460 Vac

Part Number Explanation

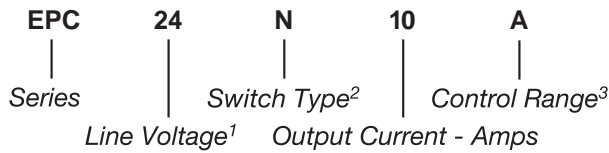

NOTES

- 1) Line Voltage (nominal): 24 = 240 Vac; 46 = 460 Vac
- 2) Switch Type: N = Phase Angle Control
- 3) Control Range: A = 0-10 Vdc; R = 4-20 mA

MECHANICAL SPECIFICATION

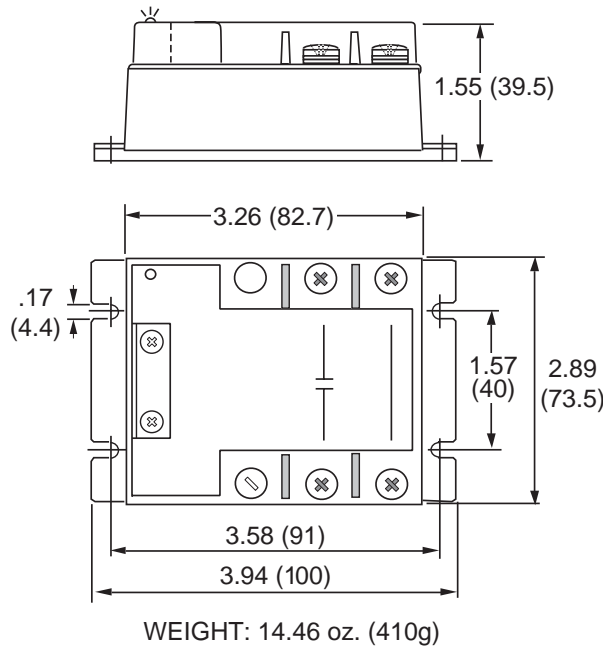

Figure 1 – EPC relays; dimensions in inches (mm)



FEATURES/BENEFITS

- External phase angle adjust
- Designed for all loads
- Excellent thermal performance
- Internal output protection
- Proportional control with voltage or current input.

DESCRIPTION

The Series EPC phase angle controller has an analog input isolated from the mains to vary the phase angle proportionally to the input and load voltage. The EPC phase angle controller is designed mainly for resistive loads. The EPC may be used with inductive loads, but with limitations. It provides internal protection from load transients. The conduction level is controlled by the input. The Series EPC provides an external adjust that allows the user to modify the cycle time for any particular application.

APPLICATIONS

- Lighting control (light dimming)
- Single-phase motors
- Heating control (regulation)

TYPICAL APPLICATION

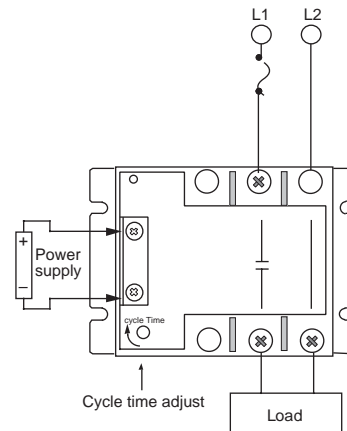

Figure 2 – EPC relays

INPUT (CONTROL) SPECIFICATION

	Min	Max	Units
Control Voltage Range			
EPCXXNXXA	0	10	V
EPC24N40R	1	5	V
Control Current Range			
EPC24N40R	5.5	20	mAdc
Must Turn-Off Voltage			
EPCXXNXXA		0.2	V
Must Turn-Off Current			
EPC24N40R		4	mA
Input Resistance (Typical)			
EPCXXNXXA		400±2%	Ohms
EPC24N40R		0.25	Ohms

OUTPUT (LOAD) SPECIFICATION

	Min	Max	Unit
Operating Range			
EPC24	115	265	Vrms
EPC46	200	460	Vrms
Peak Voltage (Clamping Voltage)			
EPC24		600 (450)	Vpeak
EPC46		1200 (800)	Vpeak
Internal Circuit Consumption			
EPC24		7	mArms
EPC46		4	mArms
Load Current Range (See Figure 8)			
EPC24N10A	.01	10	Arms
EPC24N40A	.01	40	Arms
EPC24N40R	.01	40	Arms
EPC46N70A	.01	70	Arms
EPC46N110A	.01	110	Arms

OUTPUT (LOAD) SPECIFICATION (Continued)

	Min	Max	Unit
Maximum Surge Current Rating (Non-Repetitive, See Figure 9)			
EPC24N10A		120	A
EPC24N40A		550	A
EPC24N40R		550	A
EPC46N70A		1000	A
EPC46N110A		2000	A
On-State Voltage Drop			
All relays		1.6	V
Off-State Leakage Current			
EPC24N10A		4	mArms
EPC24N40A		4	mArms
EPC24N40R		4	mArms
EPC46N70A		5	mArms
EPC46N110A		5	mArms
Turn-On Time			
All relays (60 Hz)		8.3	ms
Turn-Off Time			
All relays		41.5	ms
Operating Frequency (Trimmer must be adjusted)			
All relays	47	100	Hz
Off-State dv/dt (Non-Repetitive)			
All relays		500	V/μs
I²t for Match Fusing (<8.3ms)			
EPC24N10A		72	A ² S
EPC24N40A		1500	A ² S
EPC24N40R		1500	A ² S
EPC46N70A		5000	A ² S
EPC46N110A		20,000	A ² S

EQUIVALENT CIRCUIT

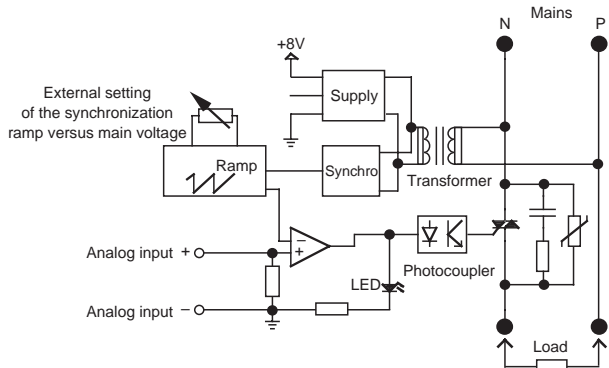
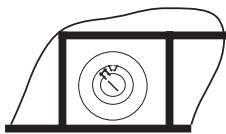

Figure 3 – EPC relays

ENVIRONMENTAL SPECIFICATION

	Min	Max	Unit
Storage Temperature	-40	85	°C
Operating Temperature	-40	85	°C
Junction Temperature	-40	125	°C
Junction-Case Thermal Resistance			
EPC24N10A		2.7	°C/W
EPC24N40A		1.1	°C/W
EPC24N40R		1.1	°C/W
EPC46N70A		0.43	°C/W
EPC46N110A		0.35	°C/W
Input-Output Isolation		8	pF
Shock (@11ms)		100	G
Vibrations (10 to 4000Hz)		50	G

EXTERNAL PHASE ANGLE ADJUST



Setting position of the integrated trimmer: 180°

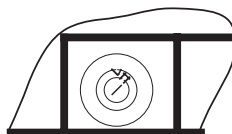

Setting position of the integrated trimmer: 90°

Figure 4 – EPC relays

Input-Output Isolation @500m

All relays	2500	Vrms
------------	------	------

Output-Case Isolation @500m

EPC24N10A	2500	Vrms
All relays	3300	Vrms

Rated Impulse Voltage

EPC24N10A	2500	V
All relays	4000	V

PRINCIPLE OF PHASE ANGLE CONTROL: INPUT/OUTPUT TRANSFER CHARACTERISTICS

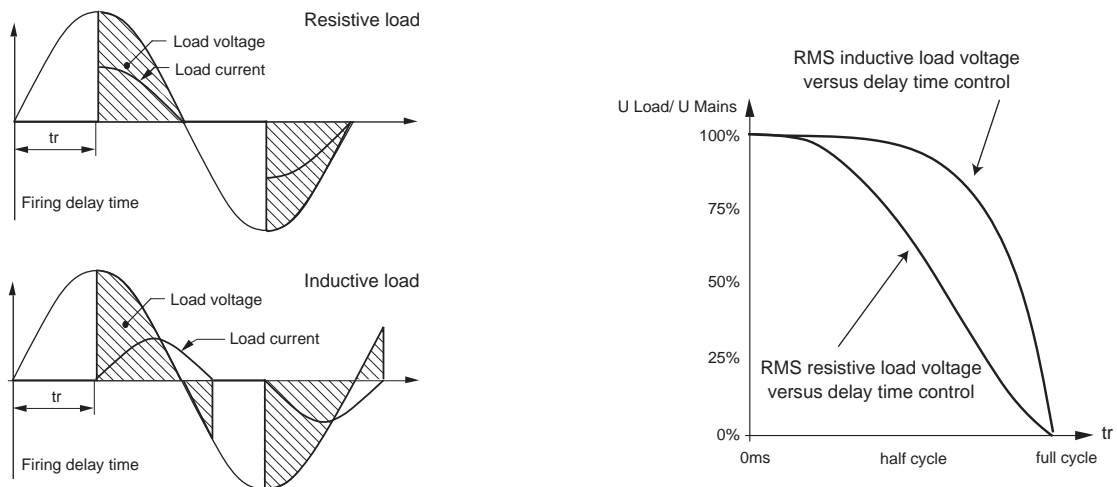

Figure 5 – EPC relays

INPUT/OUTPUT TRANSFER CHARACTERISTICS

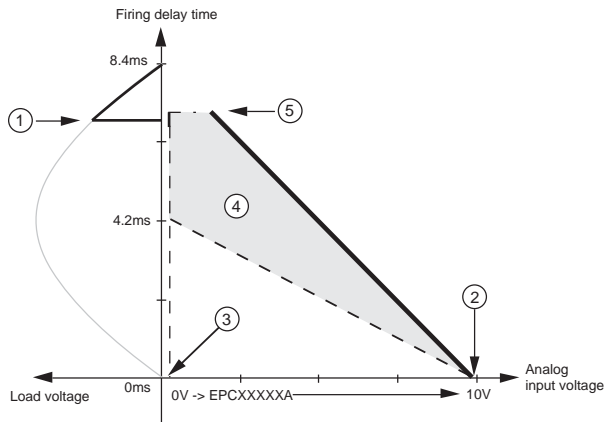

Figure 6a – EPCXXNXXA

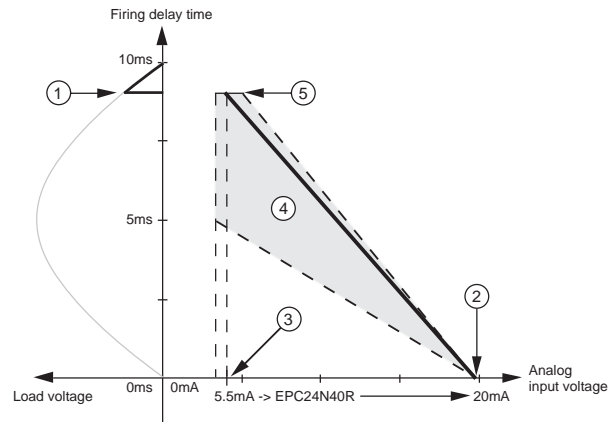

Figure 6b – EPC24N40R

1. **Factory presetting to $144^\circ \pm 10\%$ (@50Hz)** of the initial maximum firing delay angle. It can be modified by using the external phase angle adjust. A variation in the load voltage causes a small decrease of this angle. For 60Hz see item 4.
2. **Full conduction mode voltage:** Control Voltage = 10 Vdc (+0; -5%)
3. **Factory presetting to 0.2 Vdc $\pm 0.1V$** of the minimum control input voltage. Below 0.2Vdc, the relay is off; above 0.2Vdc, the relay is On at a firing delay angle that depends on the external phase angle adjust.
4. **Possible presetting zone by using the external phase angle adjust.**
5. **Firing delay angle limit:** 170° (0; +5%);
Conditions: EPC24 @ 135 Vac, EPC46 @ 240Vac

1. **Factory presetting to $170^\circ \pm 10\%$ (@50Hz)** of the initial maximum firing delay angle. It can be modified by using the external phase angle adjust. A variation in load voltage causes a small decrease of this angle. For 60Hz see item 4.
2. **Full conduction mode voltage:** 20 mA (+0; -10%)
3. **Factory presetting to 5.5 mA (+10%; -0)** of the minimum control input current.
4. **Possible presetting zone by using the external phase angle adjust.**
5. **Firing delay angle limit:** 170° (0; +5%);
Conditions: @135 Vac; Control input = 5.5 mA.

TYPICAL FILTER EXAMPLES

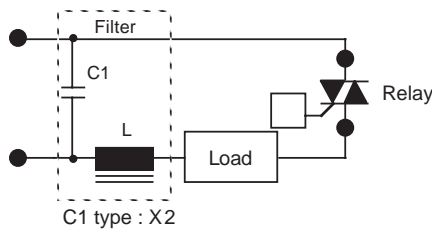

Figure 7a – Low currents

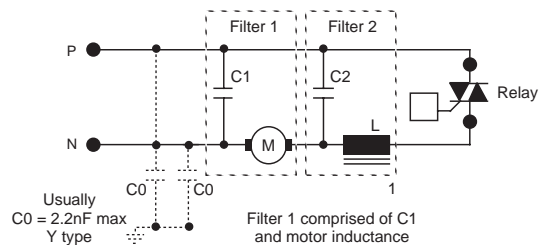

Figure 7b – High currents, filters in series

THERMAL CHARACTERISTICS

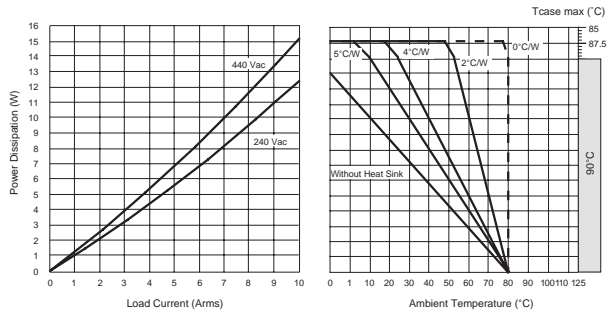

Figure 8a – EPC24N10A

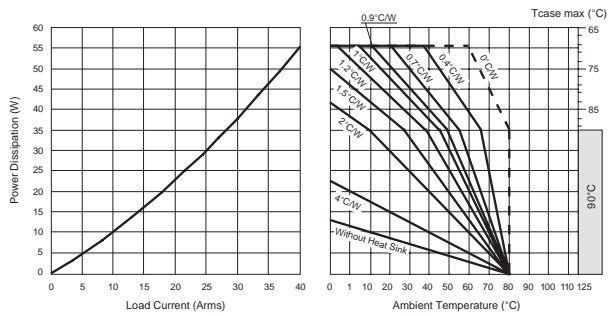

Figure 8b – EPC24N40A, EPC24N40R

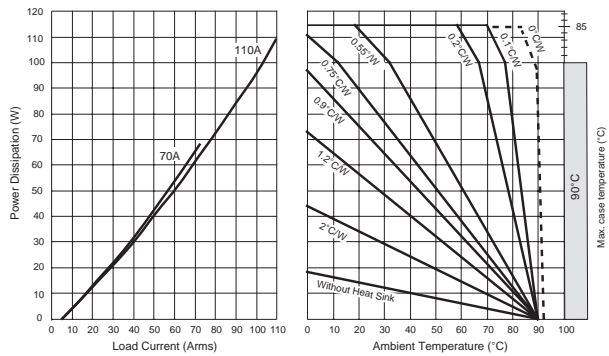

Figure 8c – EPC46N70A, EPC46N110A

SURGE CURRENT

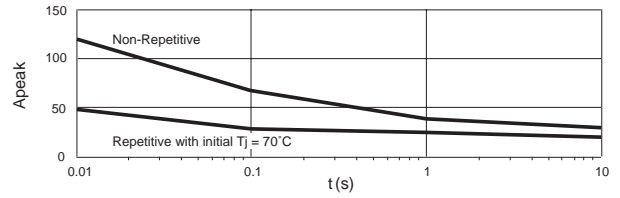

Figure 9a – EPC24N10A

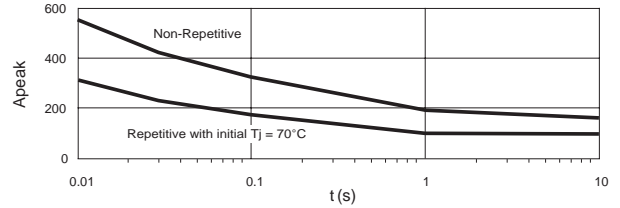

Figure 9b – EPC24N40A, EPC24N40R

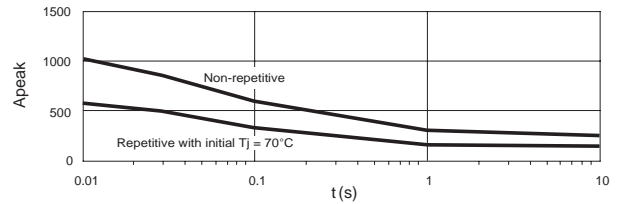

Figure 9c – EPC46N70A

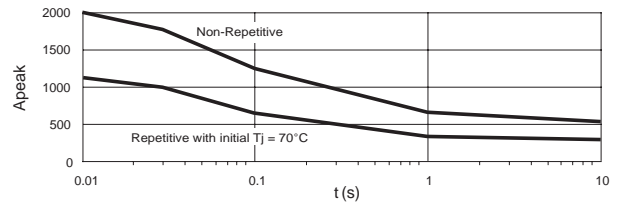

Figure 9d – EPC46N110A

NOTES:

1. Electrical specifications at 25°C unless otherwise specified.
2. Phase cutting generates RFI. Filters are recommended.
3. For inductive loads, contact factory.