

USB1T20 — Universal Serial Bus Transceiver

Features

- Complies with Universal Serial Bus Specification 2.0 for FS/LS Applications
- Utilizes Digital Inputs and Outputs to Transmit and Receive USB Cable Data
- Supports 12Mbit/s Full Speed (FS) and 1.5Mbit/s Low Speed (LS) Serial Data Transmission
- Supports Single-ended and Differential Data Interface as Function of MODE
- Single 3.3V Supply
- ESD Performance: Human Body Model
 - 9.5kV on D-, D+ Pins Only
 - 4.0kV on All Other Pins

Description

USB1T20 is a generic USB 2.0 compliant transceiver. Using a single voltage supply, the USB1T20 provides an ideal USB interface solution for any electronic device able to supply 3.0V to 3.6V. It is designed to allow 5.0V or 3.3V programmable and standard logic to interface with the physical layer of the Universal Serial Bus (USB). It is capable of transmitting and receiving serial data at both full speed (12Mbit/s) and low speed (1.5Mbit/s) data rates.

Packaged in industry-standard TSSOP package. The USB1T20 is ideal for mobile electronics and other space-constrained applications.

Ordering Information

Part Number	Operating Temperature Range	Eco Status	Package	Packing Method
USB1T20MTC	-40° to +85°C	RoHS	14-Lead Thin Shrink Small Outline Package (TSSOP) JEDEC MO-153, 4.4mm Wide	Tube
USB1T20MTCX	-40° to +85°C	RoHS	14-Lead Thin Shrink Small Outline Package (TSSOP) JEDEC MO-153, 4.4mm Wide	Tape and Reel

 For Fairchild's definition of "green" Eco Status, please visit: http://www.fairchildsemi.com/company/green/rohs_green.html.

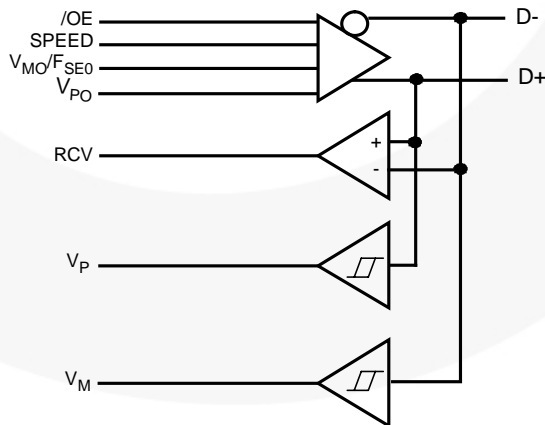

Figure 1. Logic Diagram

Pin Configuration

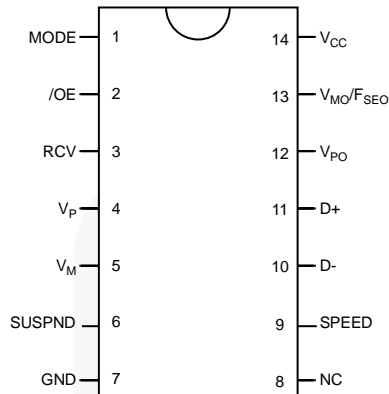

Figure 2. Pin Configuration (Top View)

Pin Definitions

Pin #	Name	I/O	Description			
1	MODE	I	Mode. When left unconnected, a weak pull-up transistor pulls mode pin to V_{CC} and, in this GND, the V_{MO}/F_{SEO} pin takes the function of F_{SEO} (force SEO).			
2	/OE	I	Output Enable. Active LOW; enables the transceiver to transmit data on the bus. When not active, the transceiver is in receive mode.			
3	RCV	O	Receive Data. CMOS-Level output for USB differential input.			
4, 5	V_P, V_M	O	Gated version of D- and D+. Outputs are logic "0" and logic "1." Used to detect single ended zero (/SEO), error conditions, and interconnected speed. (Input to SIE).			
			V_P	V_M	RESULT	
			0	0	/SEO	
			0	1	Low Speed	
			1	0	Full Speed	
0	1	Error				
6	SUSPND	I	Suspend. Enables a low-power state while the USB bus is inactive. While the suspend pin is active, it drives the RCV pin to a logic "0" state. Both D+ and D- are 3-state.			
7	GND		Ground reference.			
8	NC		No connect.			
9	SPEED	I	Edge Rate Control. Logic "1" operates at edge rates for full speed. Logic "0" operates edge rates for low speed.			
10, 11	D-, D+	A/I/O	Data+, Data-. Differential data bus conforming to the Universal Serial Bus standard.			
12, 13	$V_{PO}, V_{MO}/F_{SEO}$	I	Inputs to differential driver. (Outputs from SIE.)			
			Mode	V_{PO}	V_{MO}/F_{SEO}	RESULT
			0	0	0	Logic "0"
				0	1	/SEO
				1	0	Logic "1"
				1	1	/SEO
			1	0	0	/SEO
				0	1	Logic "0"
1	0	Logic "1"				
1	1	1	Illegal Code			
14	V_{CC}		3.0 to 3.6 power supply.			

Functional Truth Table

Input					I/O		Outputs			
Mode	V _{PO}	V _{MO} /F _{SEO}	/OE	SUSPND	D+	D-	RCV	V _P	V _M	Result
0	0	0	0	0	0	1	0	0	1	Logic "0"
0	0	1	0	0	0	0	Undefined State	0	0	/SEO
0	1	0	0	0	1	0	1	1	0	Logic "1"
0	1	1	0	0	0	0	Undefined State	0	0	/SEO
1	0	0	0	0	0	0	Undefined State	0	0	/SEO
1	0	1	0	0	0	1	0	0	1	Logic "0"
1	1	0	0	0	1	0	1	1	0	Logic "1"
1	1	1	0	0	1	1	Undefined State	Undefined State	Undefined State	Illegal Code
Don't Care	Don't Care	Don't Care	1	0	3-State	3-State	Undefined State	Undefined State	Undefined State	D+/D-Hi-Z
Don't Care	Don't Care	Don't Care	1	1	3-State	3-State	Undefined State	Undefined State	Undefined State	D+/D-Hi-Z

Absolute Maximum Ratings

Stresses exceeding the absolute maximum ratings may damage the device. The device may not function or be operable above the recommended operating conditions and stressing the parts to these levels is not recommended. In addition, extended exposure to stresses above the recommended operating conditions may affect device reliability. The absolute maximum ratings are stress ratings only.

Symbol	Parameter	Min.	Max.	Unit	
V_{CC}	DC Supply Voltage	-0.5	7.0	V	
I_{IK}	DC Input Diode Current, $V_{IN} < 0V$		-50	mA	
V_{IN}	Input Voltage ⁽¹⁾	-0.5	5.5	V	
$V_{I/O}$	Input / Output Voltage	-0.5	$V_{CC} + 0.5$	V	
I_{OK}	Output Diode Current, $V_O > V_{CC}$ or $V_O < 0$		± 50	mA	
V_O	Output Voltage ⁽¹⁾	-0.5	$V_{CC} + 0.5$	V	
I_O	Output Source or Sink Current ($V_O = 0$ to V_{CC})	V_P, V_M, RCV Pins		± 15	mA
		D+/D- Pins		± 50	
I_{CC} / I_{GND}	V_{CC} / GND Current		± 100	mA	
T_{STG}	Storage Temperature Range	-60	+150	°C	

Note:

- The input and output negative voltage ratings may be exceeded if the input and output diode current ratings are observed.

Recommended Operating Conditions

The Recommended Operating Conditions table defines the conditions for actual device operation. Recommended operating conditions are specified to ensure optimal performance to the datasheet specifications. Fairchild does not recommend exceeding them or designing to Absolute Maximum Ratings.

Symbol	Parameter	Min.	Max.	Unit
V_{CC}	Supply Voltage	3.0	3.6	V
V_{IN}	Input Voltage	0	5.5	V
$V_{AI/O}$	Input Range for AI/O	0	V_{CC}	V
V_O	Output Voltage	0	V_{CC}	V
T_A	Operating Ambient Temperature, Free Air	-40	+85	°C

DC Electrical Characteristics Digital Pins

Over the recommended range of supply voltage and operating free air temperature unless otherwise noted. $V_{CC} = 3.0V$ to $3.6V$.

Symbol	Parameter	Conditions	$T_A = -40$ to $+85^\circ C$			Units
			Min.	Typ.	Max.	
Input Levels						
V_{IL}	Low-Level Input Voltage				0.8	V
V_{IH}	High-Level Input Voltage		2			V
Output Levels						
V_{OL}	Low-Level Output Voltage	$I_{OL} = 4mA$			0.4	V
		$I_{OL} = 20\mu A$			0.1	
V_{OH}	High-Level Output Voltage	$I_{OH} = 4mA$	2.4			V
		$I_{OH} = 20\mu A$	$V_{CC}-0.1$			
Leakage Current						
I_{IN}	Input Leakage Current	$V_{CC} = 3.0$ to $3.6V$			± 5	μA
I_{CCFS}	Supply Current, Full Speed	$V_{CC} = 3.0$ to $3.6V$			5	mA
I_{CCLS}	Supply Current, Low Speed	$V_{CC} = 3.0$ to $3.6V$			5	mA
I_{CCQ}	Quiescent Supply Current	$V_{CC} = 3.0$ to $3.6V$, $V_{IN} = V_{CC}$ or GND			5	mA
I_{CCS}	Supply Current in Suspend	$V_{CC} = 3.0$ to $3.6V$, Mode = V_{CC}			10	μA

DC Electrical Characteristics D+/D- Pins

Over the recommended range of supply voltage and operating free air temperature unless otherwise noted. $V_{CC} = 3.0V$ to $3.6V$.

Symbol	Parameter	Conditions	$T_A = -40$ to $+85^\circ C$			Units
			Min.	Typ.	Max.	
Input Levels						
V_{DI}	Differential Input Sensitivity	$ (D+) - (D-) $	0.2			V
V_{CM}	Differential Common-Mode Range	Includes V_{DI} Range	0.8		2.5	V
V_{SE}	Single-Ended Receiver Threshold		0.8		2.0	V
Output Levels						
V_{OL}	Static Output Low-Voltage	R_L of $1.5k\Omega$ to $3.6V$			0.3	V
V_{OH}	Static Output High-Voltage	R_L of $1.5k\Omega$ to GND	2.8		3.6	V
V_{CR}	Differential Crossover		1.3		2.0	V
Leakage Current						
I_{OZ}	High Z-State Data Line Leakage Current	$0V < V_{IN} < 3.3V$			± 5	μA
Capacitance						
C_{IN}	Transceiver Capacitance ⁽²⁾	Pin to GND			10	pF
	Capacitance Match ⁽²⁾				10	%
Output Resistance						
Z_{DRV}	Driver Output Resistance ⁽³⁾	Steady-State Drive	4		20	Ω
	Resistance Match ⁽³⁾				10	%

Notes:

- This specification is guaranteed by design and statistical process distribution.
- Excludes external resistor. To comply with USB specification 1.1, external series resistors of $24\Omega \pm 1\%$ each on D+ and D- are recommended.

AC Electrical Characteristics D+/D- Pins, Full Speed

Over the recommended range of supply voltage and operating free air temperature unless otherwise noted.
 $V_{CC} = 3.0V$ to $3.6V$; $C_L = 50pF$; $R_L = 1.5k\Omega$ on D+ to V_{CC} .

Symbol	Parameter	Conditions	$T_A = -40$ to $+85^\circ C$			Units
			Min.	Typ.	Max.	
Driver Characteristics						
t_R, t_F	Rise and Fall Time	10 and 90%, Figure 3	4		20	ns
t_{RFM}	Rise/Fall Time Matching	t_r / t_f	90		110	%
V_{CRS}	Output Signal Crossover Voltage		1.3		2.0	V
Driver Timings						
t_{PLH}	Driver Propagation Delay ($V_{PO}, V_{MO}/F_{SEO}$ to D+/D-)	Figure 4			18	ns
t_{PHZ}, t_{PLZ}	Driver Disable Delay (/OE to D+/D-)	Figure 6			13	ns
t_{PZH}, t_{PZL}	Driver Enable Delay (/OE to D+/D-)	Figure 6			17	ns
Receiver Timings						
t_{PLH}	Receiver Propagation Delay D+/D- to RVC	Figure 5			16	ns
t_{PHL}					19	ns
t_{PLH}, t_{PHL}	Single-ended Receiver Delay (D+,D- to V_P, V_M)	Figure 5			8	ns

AC Electrical Characteristics D+/D- Pins, Low Speed

Over the recommended range of supply voltage and operating free air temperature unless otherwise noted.
 $V_{CC} = 3.0V$ to $3.6V$; $C_L = 200pF$ to $600pF$; $R_L = 1.5k\Omega$ on D- to V_{CC} .

Symbol	Parameter	Conditions	$T_A = -40$ to $+85^\circ C$			Units
			Min.	Typ.	Max.	
Driver Characteristics						
t_{LR}, t_{LF}	Rise and Fall Time	10 and 90%, Figure 3	75		300	ns
t_{RFM}	Rise/Fall Time Matching	t_r / t_f	80		120	%
V_{CRS}	Output Signal Crossover Voltage		1.3		2.0	V
Driver Timings						
t_{PLH}, t_{PHL}	Driver Propagation Delay ($V_{PO}, V_{MO}/F_{SEO}$ to D+/D-)	Figure 4			300	ns
t_{PHZ}, t_{PLZ}	Driver Disable Delay (/OE to D+/D-)	Figure 6			13	ns
t_{PZH}, t_{PZL}	Driver Enable Delay (/OE to D+/D-)	Figure 6			205	ns
Receiver Timings						
t_{PLH}, t_{PHL}	Receiver Propagation Delay (D+/D- to RVC)	Figure 5			18	ns
t_{PLH}, t_{PHL}	Single-ended Receiver Delay (D+,D- to V_P, V_M)	Figure 5			28	ns

AC Loadings and Waveforms

V_{OL} and V_{OH} are the typical output voltage drops that occur with the output load. V_{CC} never goes below 3.0V.

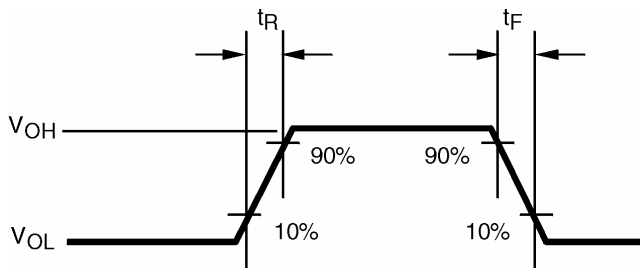

Figure 3. Rise and Fall Times

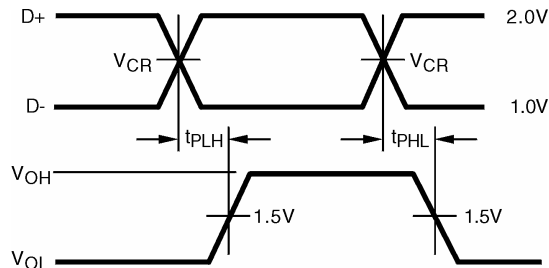

Figure 4. V_{PO} , V_{MO}/F_{SEO} to D+/D-

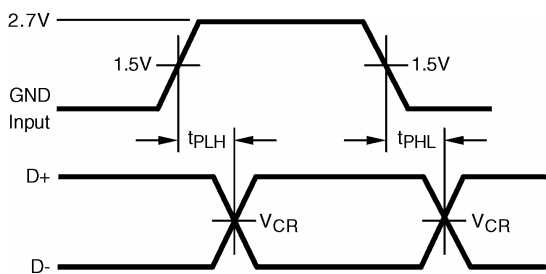

Figure 5. D+/D- to RCV, V_P/V_M

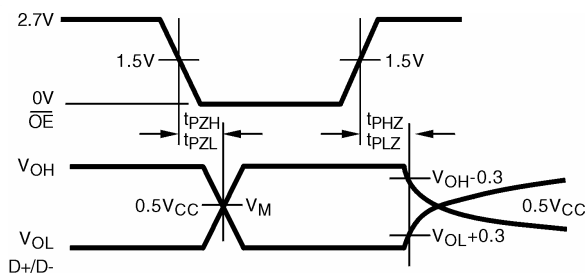

Figure 6. /OE to D+/D-

Test Circuits and Waveforms

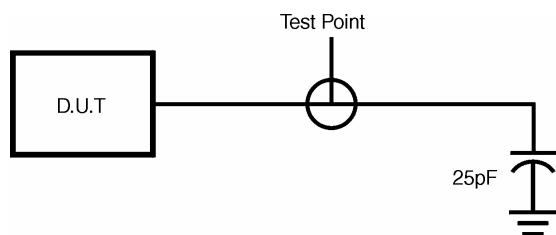

Figure 7. Load for V_M/V_P and RCV

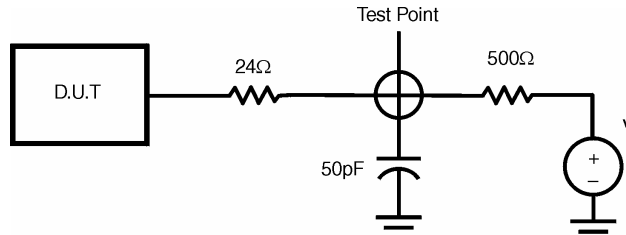
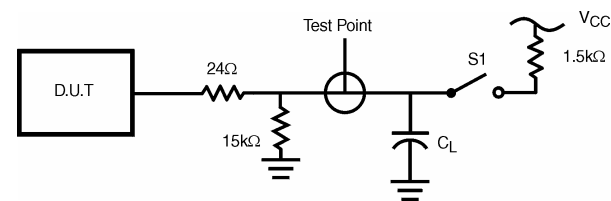

Figure 8. Load for Enable and Disable Times



$C_L=50\text{pF}$, Full Speed
 $C_L=200\text{pF}$, Low Speed (Minimum Timing)
 $C_L=600\text{pF}$, Low Speed (Maximum Timing)
 1.5k Ω on D- (Low Speed) or D+ (Full Speed) only

Test	S1
D-/LS	Close
D+/LS	Open
D-/FS	Open
D+/FS	Close

Figure 9. Load for D+/D-

Physical Dimensions

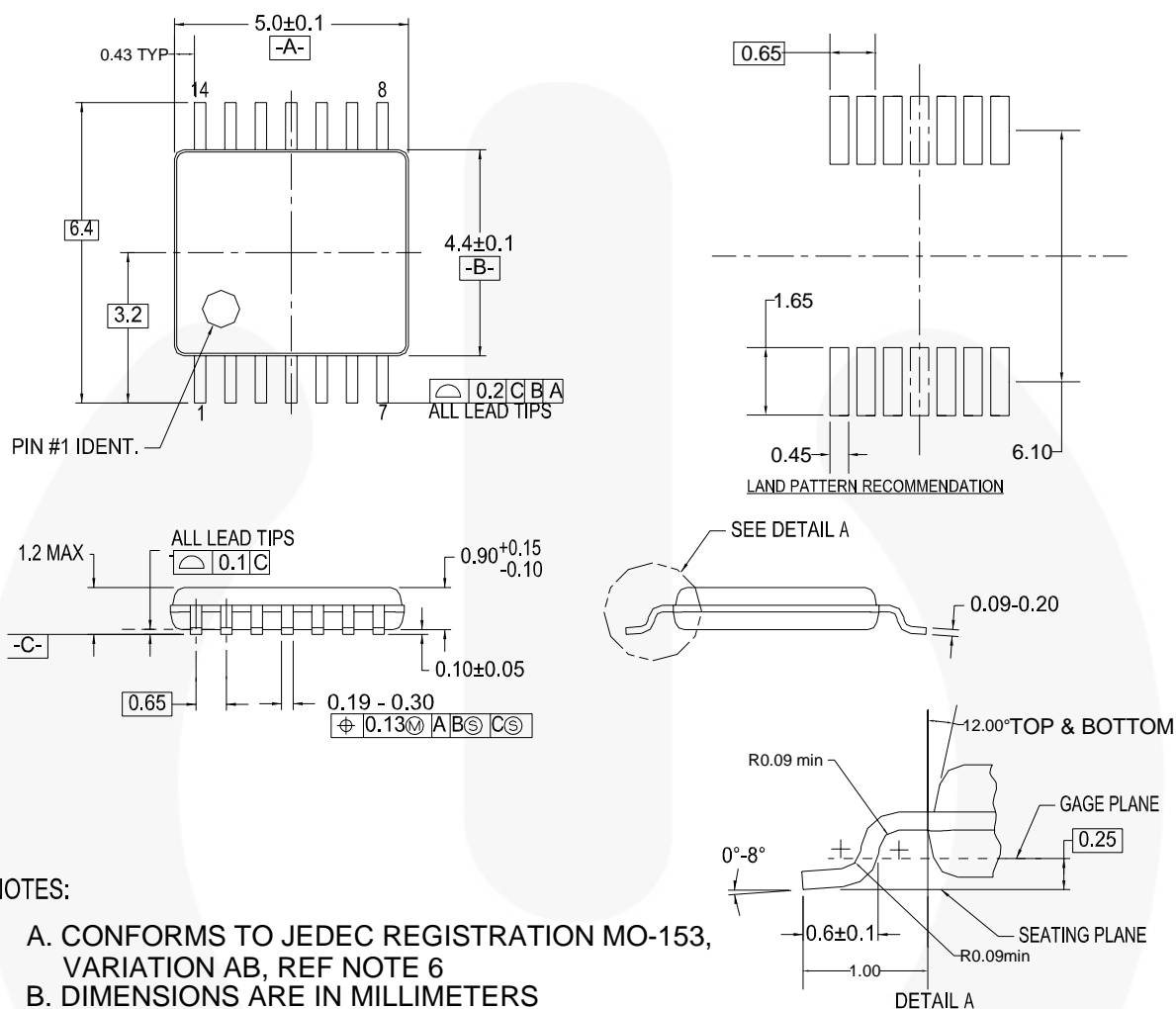

NOTES:

- A. CONFORMS TO JEDEC REGISTRATION MO-153, VARIATION AB, REF NOTE 6
- B. DIMENSIONS ARE IN MILLIMETERS
- C. DIMENSIONS ARE EXCLUSIVE OF BURRS, MOLD FLASH, AND TIE BAR EXTRUSIONS
- D. DIMENSIONING AND TOLERANCES PER ANSI Y14.5M, 1982
- E. LANDPATTERN STANDARD: SOP65P640X110-14M
- F. DRAWING FILE NAME: MTC14REV6



Package drawings are provided as a service to customers considering Fairchild components. Drawings may change in any manner without notice. Please note the revision and/or date on the drawing and contact a Fairchild Semiconductor representative to verify or obtain the most recent revision. Package specifications do not expand the terms of Fairchild's worldwide terms and conditions, specifically the warranty therein, which covers Fairchild products.

Always visit Fairchild Semiconductor's online packaging area for the most recent package drawings:
<http://www.fairchildsemi.com/packaging/>



TRADEMARKS

The following includes registered and unregistered trademarks and service marks, owned by Fairchild Semiconductor and/or its global subsidiaries, and is not intended to be an exhaustive list of all such trademarks.

Build it Now™
 CorePLUS™
 CorePOWER™
 CROSSVOLT™
 CTL™
 Current Transfer Logic™
 EcoSPARK®
 EfficientMax™
 EZSWITCH™ *

 Fairchild®
 Fairchild Semiconductor®
 FACT Quiet Series™
 FACT®
 FAST®
 FastvCore™
 FlashWriter® *
 FPS™
 F-PFS™

FRFET®
 Global Power Resource™ SM
 Green FPST™
 Green FPS™ e-Series™
 GTO™
 IntelliMAX™
 ISOPLANAR™
 MegaBuck™
 MICROCOUPLER™
 MicroFET™
 MicroPak™
 MillerDrive™
 MotionMax™
 Motion-SPM™
 OPTOLOGIC®
 OPTOPLANAR®

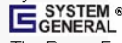
 PDP-SPM™
 Power-SPM™
 PowerTrench®
 PowerXST™

Programmable Active Droop™
 QFET®
 QS™
 Quiet Series™
 RapidConfigure™

 Saving our world, 1mW/W/kW at a time™
 SmartMax™
 SMART START™
 SPM®
 STEALTH™
 SuperFET™
 SuperSOT™.3
 SuperSOT™.6
 SuperSOT™.8
 SupreMOS™
 SyncFET™

 The Power Franchise®

the Power franchise
 TinyBoost™
 TinyBuck™
 TinyLogic®
 TINYOPTO™
 TinyPower™
 TinyPVM™
 TinyWire™

 UHC®
 Ultra FRFET™
 UniFET™
 VCX™
 VisualMax™
 XST™

* EZSWITCH™ and FlashWriter® are trademarks of System General Corporation, used under license by Fairchild Semiconductor.

DISCLAIMER

FAIRCHILD SEMICONDUCTOR RESERVES THE RIGHT TO MAKE CHANGES WITHOUT FURTHER NOTICE TO ANY PRODUCTS HEREIN TO IMPROVE RELIABILITY, FUNCTION, OR DESIGN. FAIRCHILD DOES NOT ASSUME ANY LIABILITY ARISING OUT OF THE APPLICATION OR USE OF ANY PRODUCT OR CIRCUIT DESCRIBED HEREIN; NEITHER DOES IT CONVEY ANY LICENSE UNDER ITS PATENT RIGHTS, NOR THE RIGHTS OF OTHERS. THESE SPECIFICATIONS DO NOT EXPAND THE TERMS OF FAIRCHILD'S WORLDWIDE TERMS AND CONDITIONS, SPECIFICALLY THE WARRANTY THEREIN, WHICH COVERS THESE PRODUCTS.

LIFE SUPPORT POLICY

FAIRCHILD'S PRODUCTS ARE NOT AUTHORIZED FOR USE AS CRITICAL COMPONENTS IN LIFE SUPPORT DEVICES OR SYSTEMS WITHOUT THE EXPRESS WRITTEN APPROVAL OF FAIRCHILD SEMICONDUCTOR CORPORATION.

As used herein:

1. Life support devices or systems are devices or systems which, (a) are intended for surgical implant into the body or (b) support or sustain life, and (c) whose failure to perform when properly used in accordance with instructions for use provided in the labeling, can be reasonably expected to result in a significant injury of the user.
2. A critical component in any component of a life support, device, or system whose failure to perform can be reasonably expected to cause the failure of the life support device or system, or to affect its safety or effectiveness.

ANTI-COUNTERFEITING POLICY

Fairchild Semiconductor Corporation's Anti-Counterfeiting Policy. Fairchild's Anti-Counterfeiting Policy is also stated on our external website, www.fairchildsemi.com, under Sales Support.

Counterfeiting of semiconductor parts is a growing problem in the industry. All manufacturers of semiconductor products are experiencing counterfeiting of their parts. Customers who inadvertently purchase counterfeit parts experience many problems such as loss of brand reputation, substandard performance, failed applications, and increased cost of production and manufacturing delays. Fairchild is taking strong measures to protect ourselves and our customers from the proliferation of counterfeit parts. Fairchild strongly encourages customers to purchase Fairchild parts either directly from Fairchild or from Authorized Fairchild Distributors who are listed by country on our web page cited above. Products customers buy either from Fairchild directly or from Authorized Fairchild Distributors are genuine parts, have full traceability, meet Fairchild's quality standards for handling and storage and provide access to Fairchild's full range of up-to-date technical and product information. Fairchild and our Authorized Distributors will stand behind all warranties and will appropriately address any warranty issues that may arise. Fairchild will not provide any warranty coverage or other assistance for parts bought from Unauthorized Sources. Fairchild is committed to combat this global problem and encourage our customers to do their part in stopping this practice by buying direct or from authorized distributors.

PRODUCT STATUS DEFINITIONS

Definition of Terms

Datasheet Identification	Product Status	Definition
Advance Information	Formative / In Design	Datasheet contains the design specifications for product development. Specifications may change in any manner without notice.
Preliminary	First Production	Datasheet contains preliminary data; supplementary data will be published at a later date. Fairchild Semiconductor reserves the right to make changes at any time without notice to improve design.
No Identification Needed	Full Production	Datasheet contains final specifications. Fairchild Semiconductor reserves the right to make changes at any time without notice to improve the design.
Obsolete	Not In Production	Datasheet contains specifications on a product that is discontinued by Fairchild Semiconductor. The datasheet is for reference information only.

Rev. I37