

## **BVZ-925BA4**

### ■ **Description**

This revolutionary package design allows the lighting designer to reduce the number of LEDs required and provide a more uniform and unique illuminated appearance than with other LED solutions. This is possible through the efficient optical package design and high current capabilities.

The low profile package can be easily coupled with reflectors or lenses to efficiently distribute light and provide the desired lit appearance. This product family employs the world's brightest red, red orange, amber, blue, cyan, and green LED materials, which allow designers to match the color of many lighting applications like vehicle signal lamps, specialty lighting, and electronic signs.

- Dice Material GaN Blue
- Light Color : Blue Color
- Lens Color : Water Transparent



### ■ **Features**

- High Luminance
- Uniform Color
- Low Power Consumption
- Low Thermal Resistance
- Low Profile
- Packaged in tubes for use with automatic insertion equipment
- Pb -free/ RoHS compliant

### ■ **Applications**

- Sign and channel letter
- Cove lighting
- IR-free decoration lighting
- Automotive exterior ( stop-tail-turn, CHMSL, mirror side repeat )
- Edge-lit signs ( exit, point of sale )
- Advertisement and entertainment

**Outline Dimensions : ( mm )**

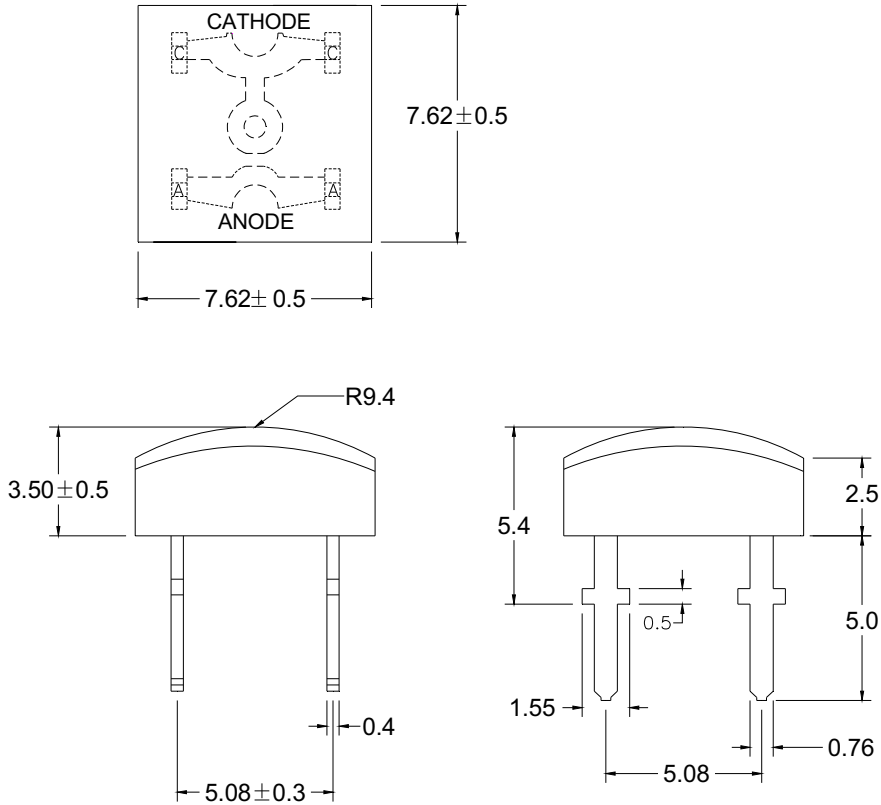
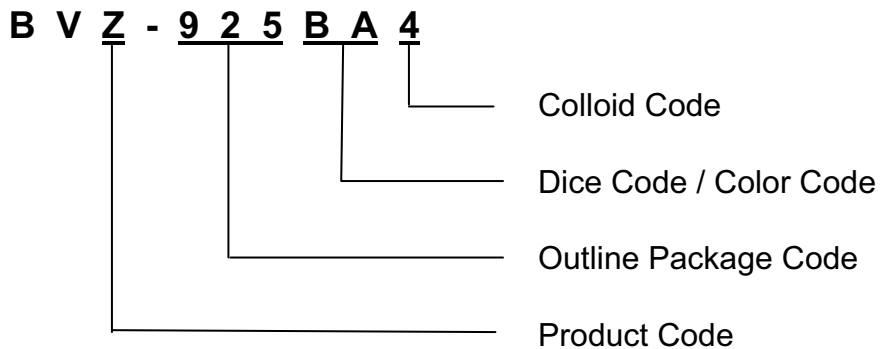
 Tolerance :  $\pm 0.25$  mm

**Part Numbering System :**

**Sub Part Numbering :**

Please also refer to the label on product bags and cartons.

**BVZ-925BA4**
**■ Absolute Maximum Ratings at Ta = 25 °C**

PARAMETER	symbol	MAX.	UNIT
Power Dissipation	PD	120	mW
Continuous Forward Current	IF	30	mA
Peak Forward Current ( 1/10 Duty Cycle , 0.1ms Pulse Width)	IFP	100	mA
Reverse Voltage	VR	5	V
Derating Linear From 25°C		0.4	mA/°C
Operating Temperature Range	Topr	-30 to + 80	°C
Storage Temperature Range	Tstg	-40 to + 100	°C
LED Junction Temperature	Tj	125	°C
Soldering Preheat Temperature		100 °C for 30 sec.	
Lead Solder Temperature ( 1.5mm Below Seating Plane )	Tsld	260 °C for 5 sec. 1 time.	

**■ Electro-Optical Characteristics at Ta = 25 °C**

PARAMETER	SYMBOL	TEST CONDITION	VALUES			UNIT
			MIN.	TYP.	MAX.	
Forward Voltage	$V_F$	$I_F=30\text{mA}$	—	3.2	4	V
Reverse Current	$I_R$	$V_R= 5\text{V}$	—	—	10	$\mu\text{A}$
Peak Emission Wavelength	$\lambda_p$	$I_F=30\text{mA}$	—	465	—	nm
Dominant Wavelength	$\lambda_d$	$I_F=30\text{mA}$	—	470	—	nm
Viewing Angle	$2\theta$ 1/2	$I_F=30\text{mA}$	—	100	—	Deg.
Luminous Intensity / Total Flux	$IV/\Phi_V$		—	0.3	—	cd/lm
Thermal Resistance	$R_{\theta j-pin}$		—	125	—	°C/W

**■ Bin Grade Limits (  $I_F = 30 \text{ mA}^*$  ) Luminous Intensity / lm**

Bin	D	E	F	G	H	I
Min.	1.7	2.2	2.8	3.6	4.7	6.0
Max.	2.2	2.8	3.6	4.7	6.0	7.8

Tolerance :  $\pm 15\%$

**■ Bin Grade Limits (  $I_F = 30 \text{ mA}^*$  ) Dominant Wavelength / nm**

Bin	BM	BN	BO	BP
Min.	460	465	470	475
Max.	465	470	475	480

Please contact our sales department for more information

**■ Bin Grade Limits (  $I_F = 30 \text{ mA}^*$  ) Forward Voltage**

Bin	28	30	32	34	36	38	40
Min.	2.8	3.0	3.2	3.4	3.6	3.8	4.0
Max.	3.0	3.2	3.4	3.6	3.8	4.0	4.2

Please contact our sales department for more information

**Characteristics Data**

GaN Blue LED

## TYPICAL ELECTRICAL / OPTICAL CHARACTERISTIC CURVES

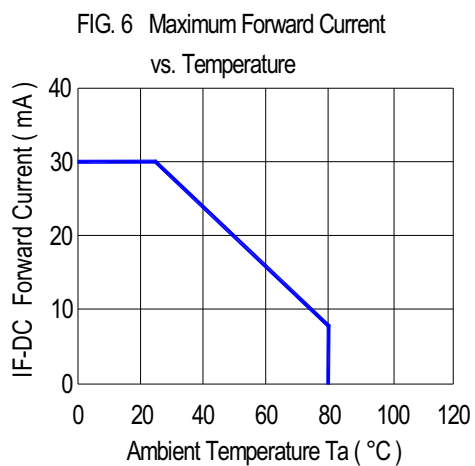
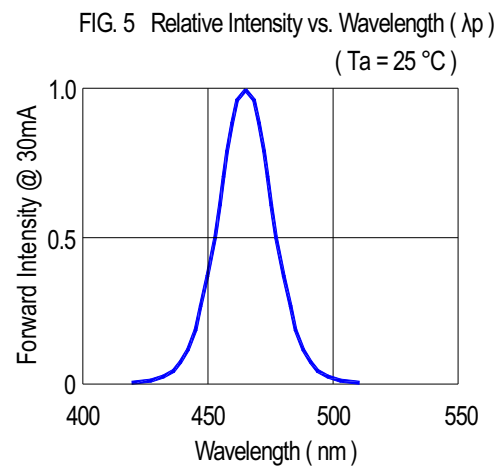
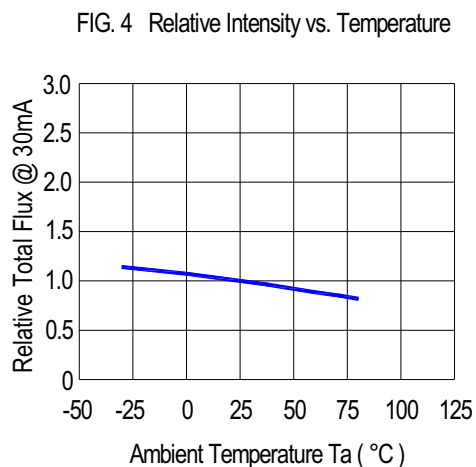
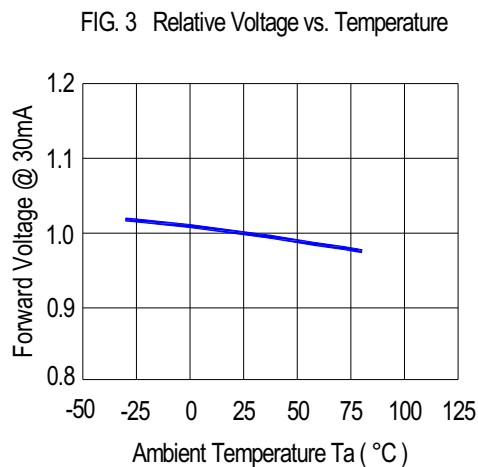
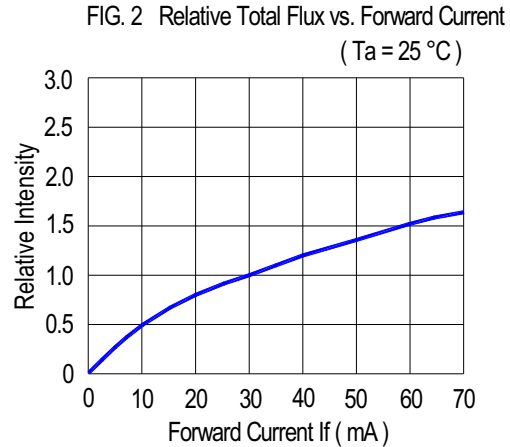
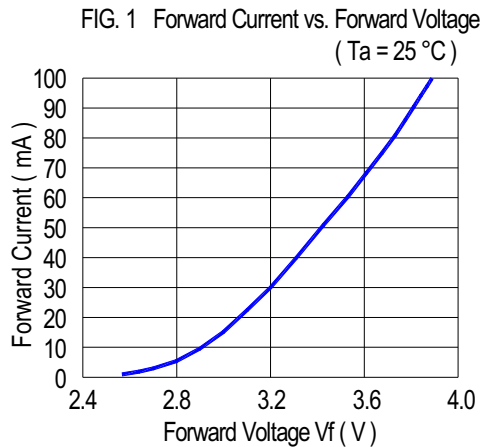

■ **Radiation Characteristic :**

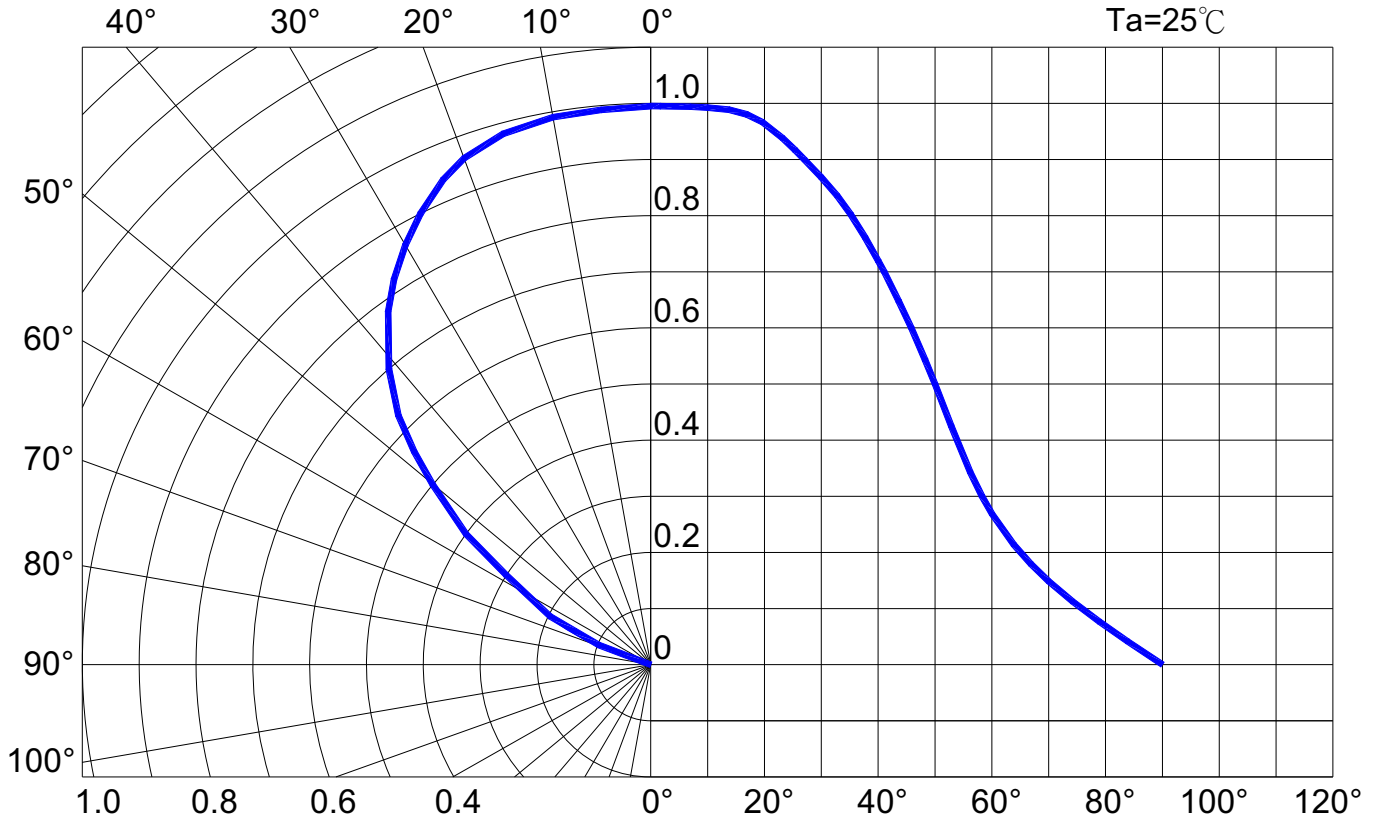

## BVZ-925BA4

### ■ Packaging :

#### ■ Package Carrier Tape Dimensions :

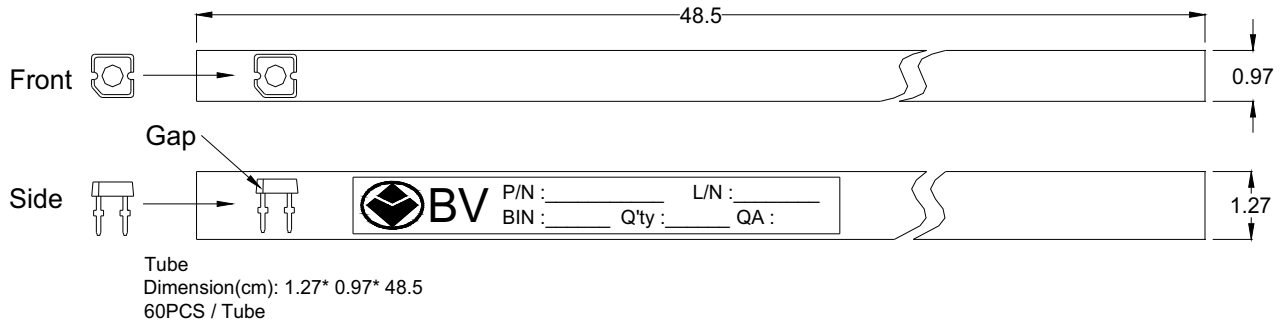

#### ■ Package Reel Dimensions :

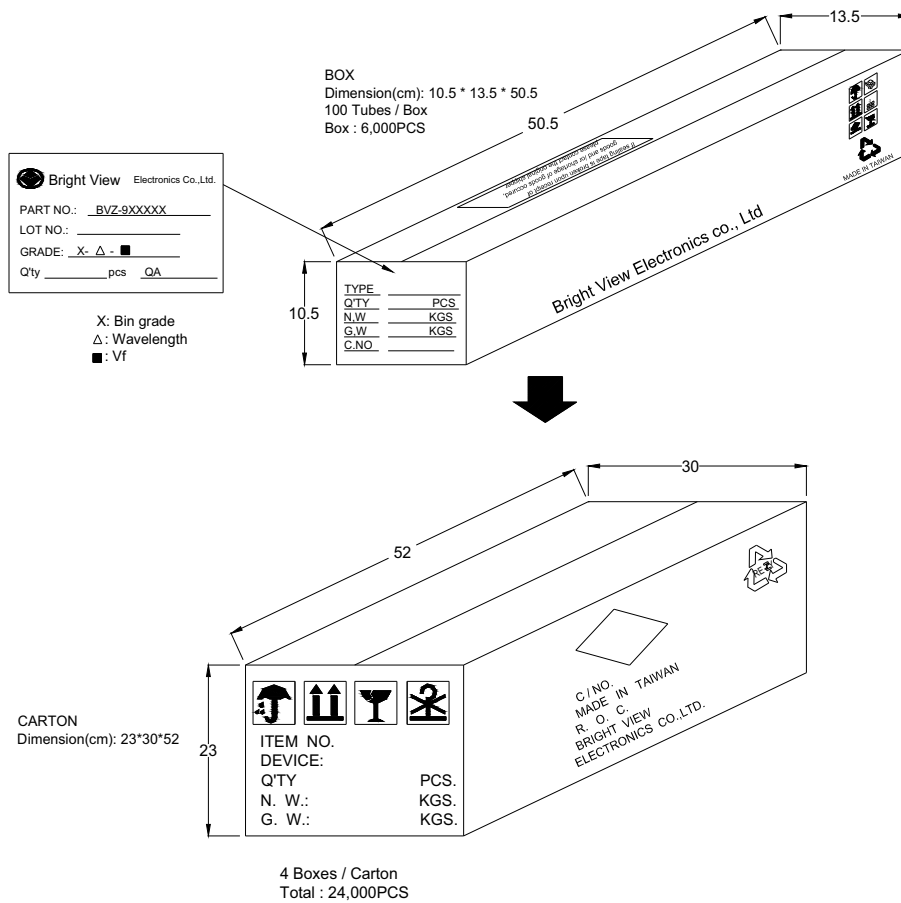

**■ Reliability Test Items and Conditions**
**(1)TEST ITEMS AND RESULTS**

TEST ITEM	Standard Test Method	Test Conditions	Note	Number of Damaged
Resistance to Soldering Heat	JEITA ED-4701 300 302	Tsld=260°C ± 5°C, 5sec. 1.6mm from the base of the stopper (Pre-treatment 30°C,70%,168hrs.)	1 times	0/50
Solderability	JEITA ED-4701 300 303	Tsld=235 ± 5°C, 5sec. (using flux)	1 time over 95%	0/50
Thermal Shock		0°C ~ 100°C 30min. 30min.	100 cycles	0/50
Temperature Cycle	JEITA ED-4701 100 105	-40°C ~ 25°C ~ 100°C ~ 25°C 30min. 5min. 30min. 5min.	100 cycles	0/50
Moisture Resistance Cyclic	JEITA ED-4701 200 203	25°C ~ 65°C ~ -10°C 90%RH 24hrs./1cycle	10 cycles	0/50
Terminal Strength (bending test)	JEITA ED-4701 400 401	Load 5N (0.5kgf) 0° ~ 90° ~ 0° bend 2 times	No noticeable damage	0/50
Terminal Strength (pull test)	JEITA ED-4701 400 401	Load 10N (1kgf) 10 ± 1 sec.	No noticeable damage	0/50
High Temperature Storage	JEITA ED-4701 200 201	Ta=100°C	1000hrs.	0/50
Temperature Humidity Storage	JEITA ED-4701 100 103	Ta=60°C, RH=90%	1000hrs.	0/50
Low Temperature Storage	JEITA ED-4701 200 202	Ta=-40°C	1000hrs.	0/50
Steady State Operating Life		Ta=25°C, IF=30mA	1000hrs.	0/50
Steady State Operating Life of High Humidity Heat		60°C, RH=90%, IF=15mA	500hrs.	0/50
Steady State Operating Life of Low Temperature		Ta=-30°C, IF=30mA	1000hrs.	0/50

**(2)CRITERIA FOR JUDGING DAMAGE**

Item	Symbol	Test Conditions	Criteria for Judgement	
			Min	Max
Forward Voltage	V <sub>F</sub>	I <sub>F</sub> =30mA	—	U.S.L.*) x 1.1
Reverse Current	I <sub>R</sub>	V <sub>R</sub> =5V	—	U.S.L.*) x 2.0
Luminous Flux	Φ <sub>V</sub>	I <sub>F</sub> =30mA	L.S.L.**) x 0.7	—

\*)U.S.L.:Upper Standard Level

\*\*)L.S.L.:Lower Standard Level





## **BVZ-925BA4**

### ■ **Cautions :**

#### (1) Storage Conditions :

- \* The LEDs should be kept at 30°C or less and 60% RH or less and should be used within a year and should be soldered within 168 hours (7days) after opening the package.

#### (2) Heat Generation

- \* The thermal design of the end product is very important. It is necessary to avoid intense heat generation and operate within the maximum ratings given in this specification.
- \* The operating current should be decided after considering the ambient maximum temperature of LEDs.

#### (3) Cleaning

- \* Isopropyl alcohol is recommended to be used as a solvent for cleaning the LEDs.
- \* Before cleaning, a pre-test should be done to confirm whether any damage to the LEDs will occur.

## BVZ-925BA4

### (4) Soldering

- \* Bright View LEDs use a copper alloy lead frame which provides a high thermal conductivity. Thermal stress such as soldering heat may reduce the reliability of the product; particular caution should be used to avoid damage prior to and during soldering. The recommended soldering conditions are listed in the following table.
- \* Although the recommended soldering conditions are specified in the below table, dip or soldering at the lowest possible temperature is desirable.
- \* When it is necessary to clamp the LEDs to prevent soldering failure, it is important to the mechanical stress on the LEDs.
- \* Solder the LED no closer than 1.6mm from the base of the stopper.
- \* Dip soldering and hand soldering should not be done more than one time.
- \* A rapid-rate process is not recommended for cooling the LEDs down from the peak temperature.
- \* Cut the LED leadframes at room temperature. Cutting the leadframes at high temperature may cause failure of the LEDs.
- \* Recommended soldering conditions

Hand Soldering		Dip Soldering	
Temperature	350°C Max.	Pre-Heat	120°C Max.
Soldering Time	3 seconds Max.	Pre-Heat Time	60 seconds Max.
Position	No closer than 1.6 mm from the base of the stopper.	Solder Bath Temperature	260°C Max.
		Dipping Time	5 seconds Max.
		Dipping Position	No lower than 1.6 mm from the base of the stopper.



**BVZ-925BA4**

(5) Other

- \* Care must be taken to ensure that the reverse voltage will not exceed the absolute maximum rating when using the LEDs with matrix drive.
- \* The LED light output is strong enough to injure human eyes. Precaution must be taken to prevent looking directly at the LEDs with unaided eyes for more than a few seconds
- \* The LEDs described here are intended to be used for ordinary electronic equipment, please consult Bright View's sales department in advance for information on applications.
- \* The appearance and specifications of the product may be modified for improvement without notice.