

## N-Channel Enhancement Mode Field Effect Transistor

### General Description

This Power MOSFET is produced using planar stripe, DMOS technology. This latest technology has been especially designed to minimize on-state resistance, have a high rugged avalanche characteristics. This devices is specially well suited for half bridge and full bridge resonant topolgy like a electronic lamp ballast.

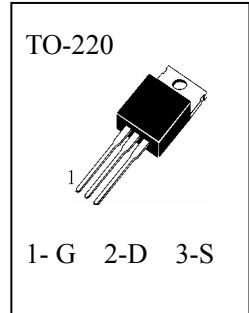

### Features

- 4.5A, 500V,  $R_{DS(on)} = 1.5\Omega @ V_{GS} = 10\text{ V}$
- Fast switching
- 100% avalanche tested
- Improved dv/dt capability
- Equivalent Type:IRF830

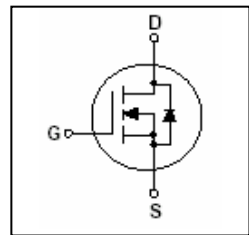

### Maximum Ratings (Ta=25°C unless otherwise specified)

$T_{stg}$	Storage Temperature	-----	-55~150°C
$T_j$	Operating Junction Temperature	-----	-55~150°C
$V_{DSS}$	Drain-Source Voltage	-----	500V
$V_{DGR}$	Drain-Gate Voltage ( $R_{GS}=1M\Omega$ )	-----	500V
$V_{GSS}$	Gate-Source Voltage	-----	±20V
$I_D$	Drain Current (Continuous)	-----	4.5A
$P_D$	Maximum Power Dissipation	-----	75W
$I_{AR}$	Avalanche Current, Repetitive or Not-Repetitive (pulse width limited by $T_j$ max, $d < 1\%$ )	-----	4.5 A
$E_{AS}$	Single Pulse Avalanche Energy (starting $T_j = 25^\circ\text{C}$ , $I_D = I_{AR}$ , $V_{DD} = 50\text{ V}$ )	-----	270 mJ
$E_{AR}$	Repetitive Avalanche Energy(pulse width limited by $T_j$ max, $d < 1\%$ )	-----	7.3mJ

### Thermal Characteristics

Symbol	Items	TO-220	Unit
Rthj-case	Thermal Resistance Junction-case	Max 1.71	°C/W
Rthj-amb	Thermal Resistance Junction-ambient	Max 62.5	°C/W
Rth c-s	Thermal Resistance Case-sink	Typ 0.5	°C/W

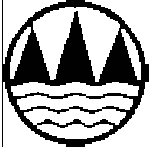

**Electrical Characteristics** (Ta=25°C unless otherwise specified)

Symbol	Items	Min.	Typ.	Max.	Unit	Conditions
<b>Off Characteristics</b>						
BV <sub>DSS</sub>	Drain-Source Breakdown Voltage	500			V	I <sub>D</sub> =250μA, V <sub>GS</sub> =0V
I <sub>DSS</sub>	Zero Gate Voltage Drain Current			25	μA	V <sub>DS</sub> =500V, V <sub>GS</sub> =0V
				250	μA	V <sub>DS</sub> =400V, V <sub>GS</sub> =0V, T <sub>j</sub> =125°C
I <sub>GSS</sub>	Gate – Body Leakage			±100	nA	V <sub>GS</sub> = ±20V, V <sub>DS</sub> =0V
<b>On Characteristics</b>						
V <sub>GS(TH)</sub>	Gate Threshold Voltage	2.0		4.0	V	V <sub>DS</sub> = V <sub>GS</sub> , I <sub>D</sub> =250μA
R <sub>DS(ON)</sub>	Static Drain-Source On-Resistance			1.5	Ω	V <sub>GS</sub> =10V, I <sub>D</sub> =2.5A
g <sub>FS</sub>	Forward Transconductance	2.5			S	V <sub>DS</sub> =40V, I <sub>D</sub> =2.5A
<b>Dynamic Characteristics and Switching Characteristics</b>						
C <sub>iss</sub>	Input Capacitance			800	pF	V <sub>DS</sub> = 25 V, V <sub>GS</sub> = 0 V, f = 1.0 MHz
C <sub>oss</sub>	Output Capacitance			200	pF	
C <sub>rss</sub>	Reverse Transfer Capacitance			60	pF	
t <sub>d(on)</sub>	Turn - On Delay Time			30	nS	V <sub>DD</sub> = 200 V, I <sub>D</sub> = 2.5Apk R <sub>G</sub> = 15 Ω
t <sub>r</sub>	Rise Time			30	nS	
t <sub>d(off)</sub>	Turn - Off Delay Time			55	nS	
t <sub>f</sub>	Fall Time			30	nS	
Q <sub>g</sub>	Total Gate Charge		22		nC	V <sub>DS</sub> =0.8V <sub>DSS</sub> , I <sub>D</sub> =4.5A, V <sub>GS</sub> = 10 V
Q <sub>gs</sub>	Gate–Source Charge		12		nC	
Q <sub>gd</sub>	Gate–Drain Charge		10		nC	
<b>Drain-Source Diode Characteristics and Maximun Ratings</b>						
I <sub>S</sub>	Continuous Source–Drain Diode Forward Current			4.5	A	
I <sub>SM</sub>	Pulsed Drain-Source Diode Forward Current			18	A	
V <sub>SD</sub>	Source–Drain Diode Forward On–Voltage			1.5	V	I <sub>S</sub> =4.5A, V <sub>GS</sub> =0

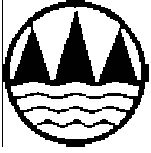

Typical Characteristics ( $T_a=25^\circ\text{C}$  unless otherwise specified)

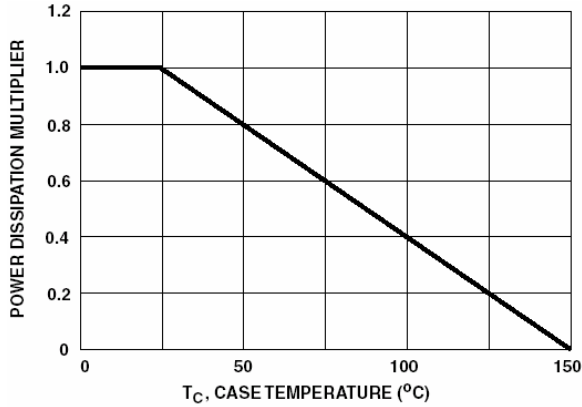

FIGURE 1. NORMALIZED POWER DISSIPATION vs CASE TEMPERATURE

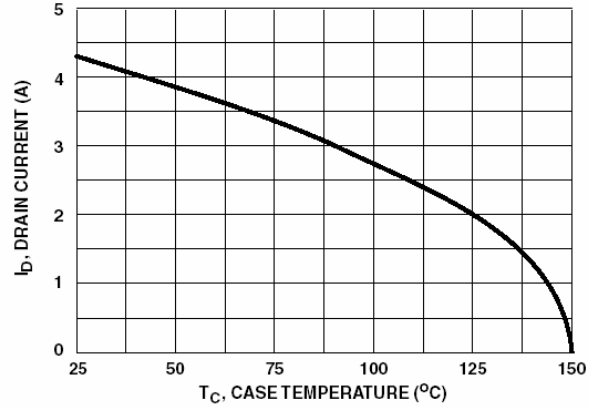

FIGURE 2. MAXIMUM CONTINUOUS DRAIN CURRENT vs CASE TEMPERATURE

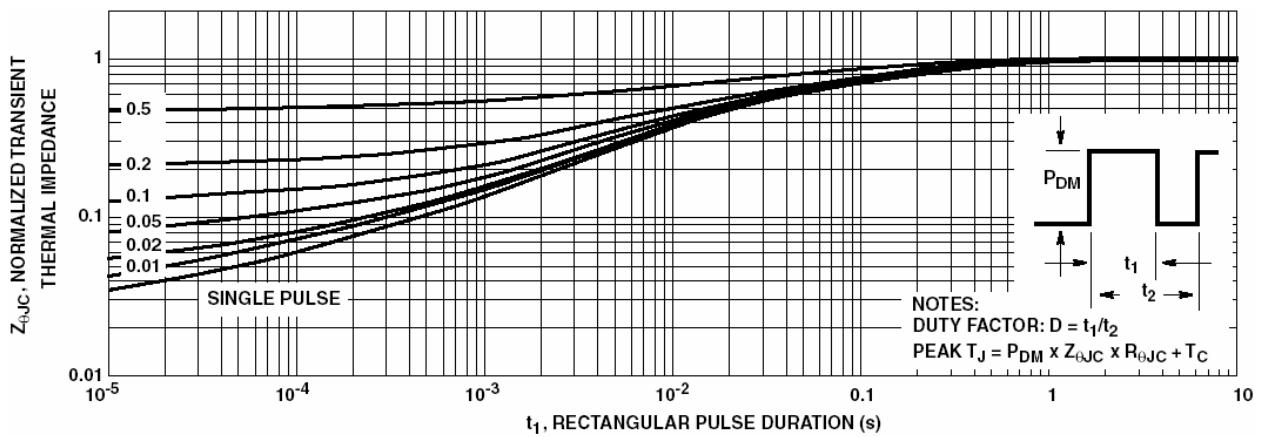

FIGURE 3. NORMALIZED MAXIMUM TRANSIENT THERMAL IMPEDANCE

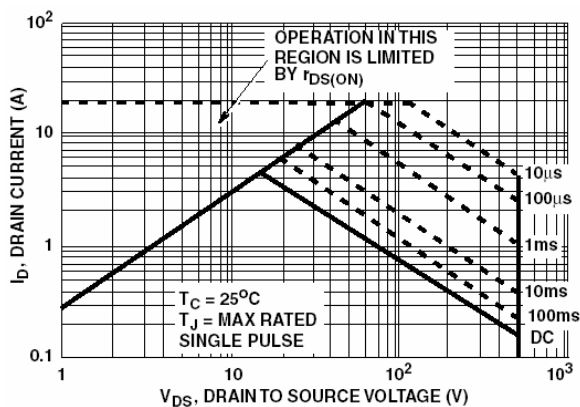

FIGURE 4. FORWARD BIAS SAFE OPERATING AREA

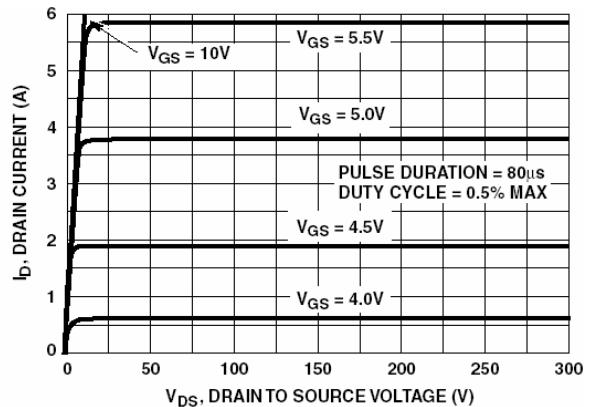
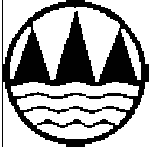

FIGURE 5. OUTPUT CHARACTERISTICS



■ Typical Characteristics (Ta=25°C unless otherwise specified)

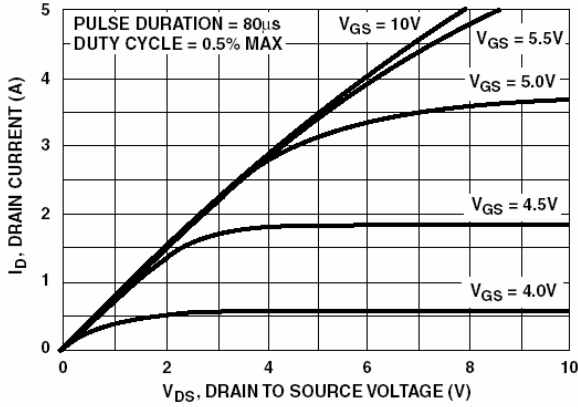

FIGURE 6. SATURATION CHARACTERISTICS

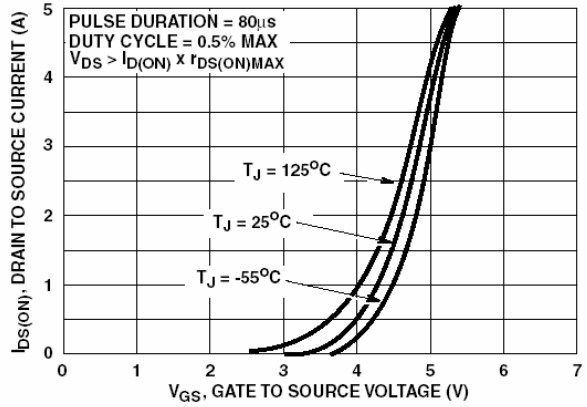

FIGURE 7. TRANSFER CHARACTERISTICS

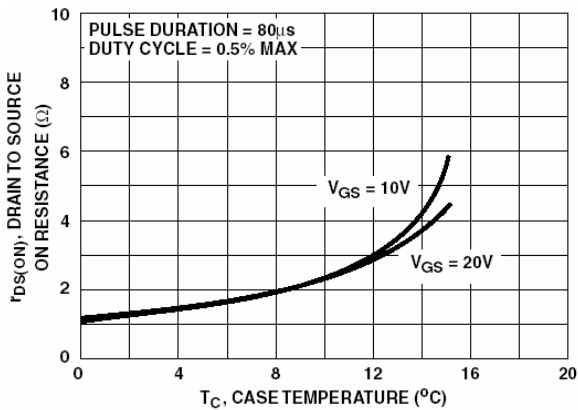

FIGURE 8. DRAIN TO SOURCE ON RESISTANCE vs GATE VOLTAGE AND DRAIN CURRENT

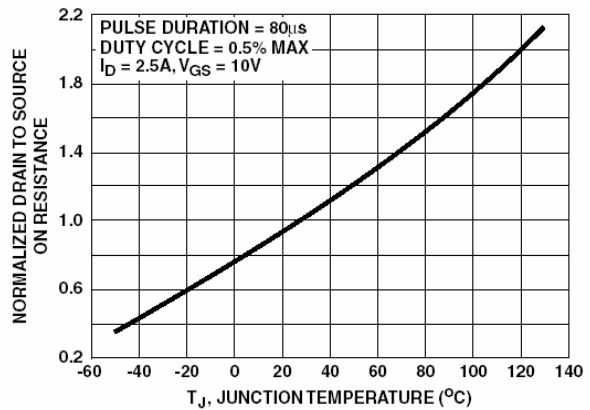

FIGURE 9. NORMALIZED DRAIN TO SOURCE ON RESISTANCE vs JUNCTION TEMPERATURE

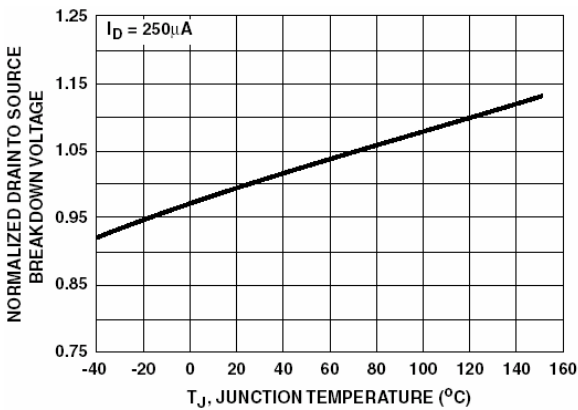

FIGURE 10. NORMALIZED DRAIN TO SOURCE BREAKDOWN VOLTAGE vs JUNCTION TEMPERATURE

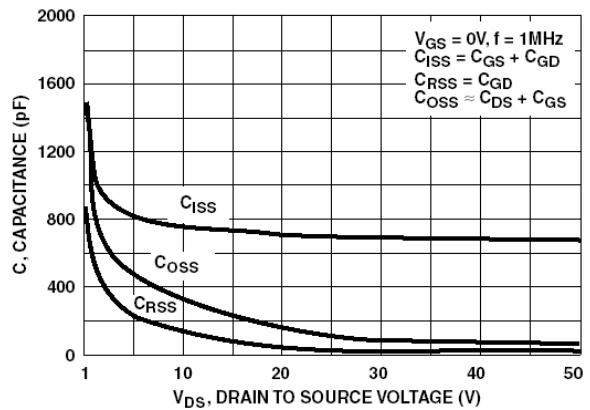
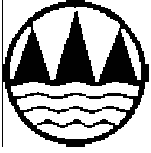

FIGURE 11. CAPACITANCE vs DRAIN TO SOURCE VOLTAGE



## Typical Characteristics (Ta=25°C unless otherwise specified)

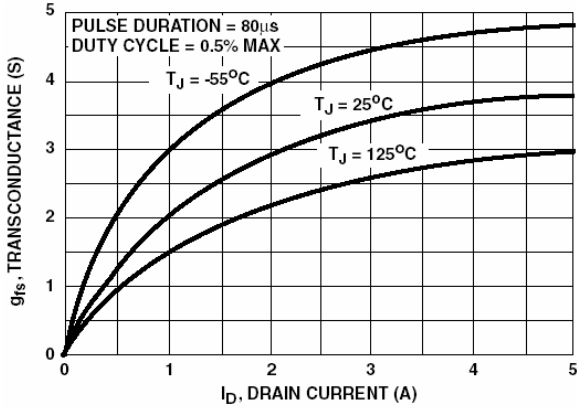

FIGURE 12. TRANSCONDUCTANCE vs DRAIN CURRENT

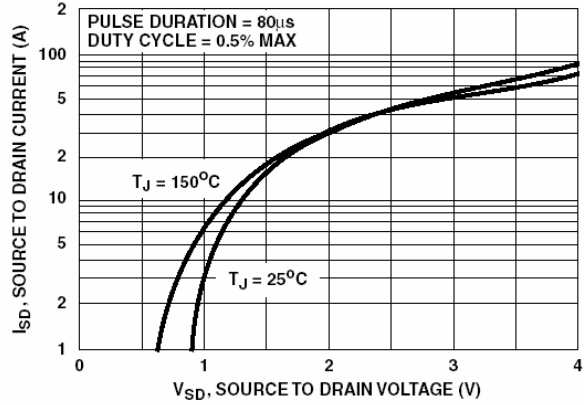

FIGURE 13. SOURCE TO DRAIN DIODE VOLTAGE

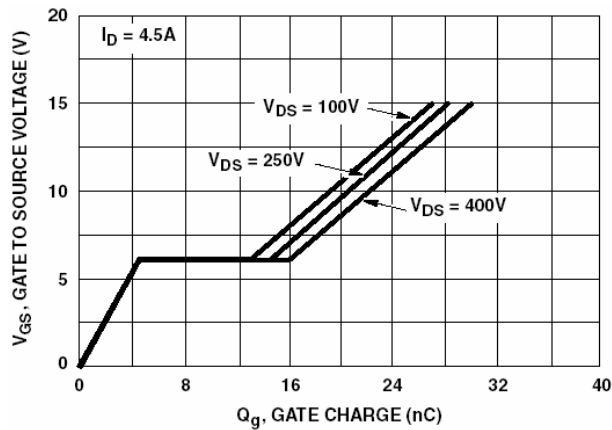
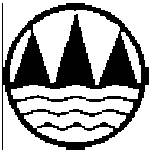

FIGURE 14. GATE TO SOURCE VOLTAGE vs GATE CHARGE



Typical Characteristics (Ta=25°C unless otherwise specified)

Test Circuits and Waveforms

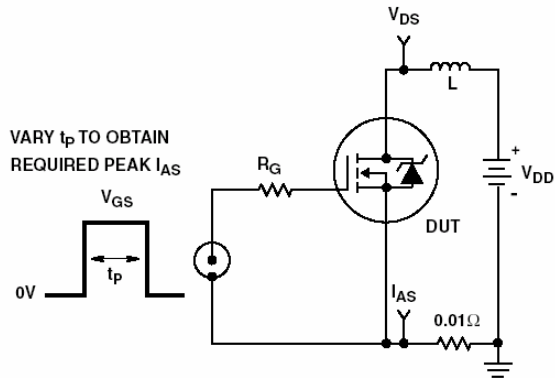

FIGURE 15. UNCLAMPED ENERGY TEST CIRCUIT

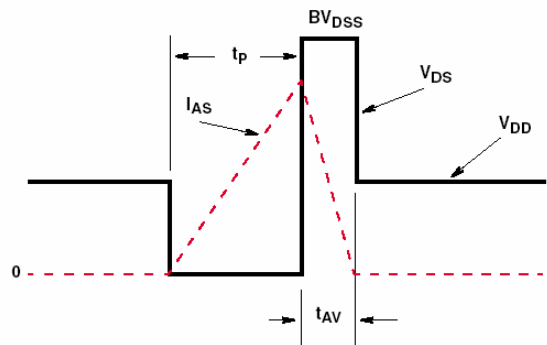

FIGURE 16. UNCLAMPED ENERGY WAVEFORMS

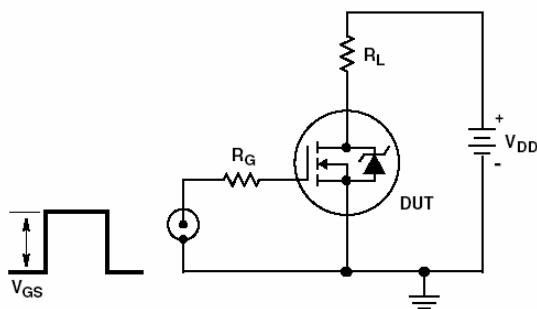

FIGURE 17. SWITCHING TIME TEST CIRCUIT

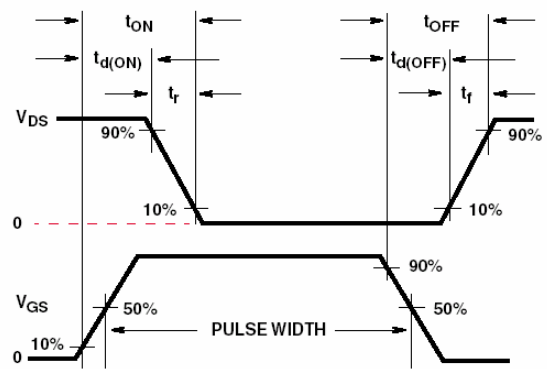

FIGURE 18. RESISTIVE SWITCHING WAVEFORMS

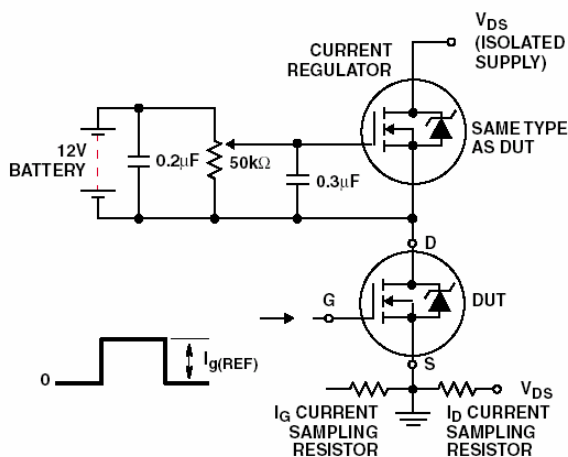

FIGURE 19. GATE CHARGE TEST CIRCUIT

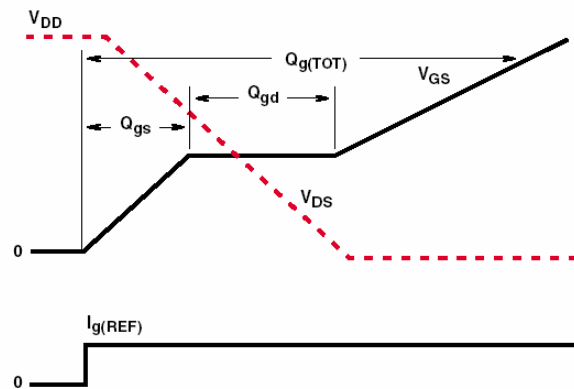

FIGURE 20. GATE CHARGE WAVEFORMS