

PLEASE CHECK WWW.MOLEX.COM FOR LATEST PART INFORMATION

Part Number: [0351500300](#)
Status: **Active**
Overview: [versablade](#)
Description: 7.30mm (.287") Pitch Wire-to-Wire VersaBlade™ Hybrid Plug Housing, without Mounting Ears, 3 Circuits, Polyester UL94V-0, Natural

Documents:

[3D Model](#) [RoHS Certificate of Compliance \(PDF\)](#)
[Drawing \(PDF\)](#)

Agency Certification

CSA	LR19980
TUV	R72090206
UL	E29179

General

Product Family	Crimp Housings
Series	35150
Comments	Polarized to Mating Part, Positive Lock
Overview	versablade
Product Name	VersaBlade™

Physical

Circuits (maximum)	3
Color - Resin	Natural
Flammability	94V-0
Gender	Female
Glow-Wire Compliant	No
Keying to Mating Part	None
Lock to Mating Part	Yes
Material - Resin	Polyester
Number of Rows	1
Packaging Type	Bag
Panel Mount	No
Pitch - Mating Interface (in)	0.287 In
Pitch - Mating Interface (mm)	7.30 mm
Polarized to Mating Part	Yes
Stackable	No
Temperature Range - Operating	-40°C to +120°C

Material Info

Reference - Drawing Numbers

Sales Drawing	SD-35150-030*
---------------	---------------

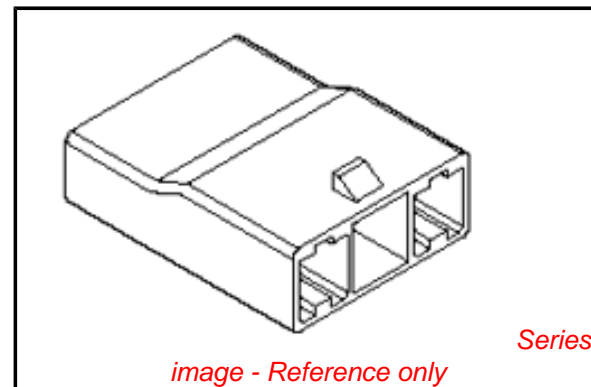

EU RoHS

ELV and RoHS Compliant
REACH SVHC
 Not Reviewed
Halogen-Free Status
Not Reviewed

China RoHS



Need more information on product environmental compliance?

Email productcompliance@molex.com
 For a multiple part number RoHS Certificate of Compliance, [click here](#)

Please visit the [Contact Us](#) section for any non-product compliance questions.

Search Parts in this Series

[35150Series](#)

Mates With

[35151-031*](#) Receptacle Housing

Use With

VersaBlade™ Crimp Terminals, [35745](#) , [35747](#) , [35746](#) <BR [351500290](#) TPA™

10 9 8 7 6 5 4 3 2 1

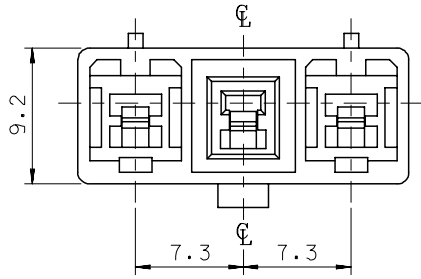

- NOTES
1. MATERIAL & COLOR : SEE TABLE
 2. MATCHED HOUSING : 35151-031*
35150-069* (T.P.A)
 3. APPLICABLE TERMINAL : 35745-0*10 (1 CIRCUIT)
35746-0*10 (2 CIRCUIT)
35747-0*10 (3 CIRCUIT)

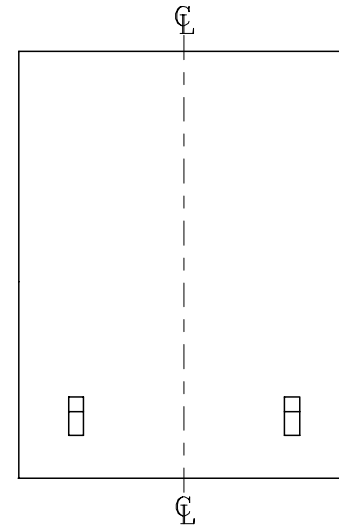
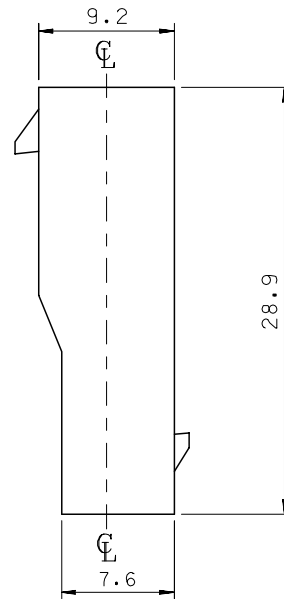
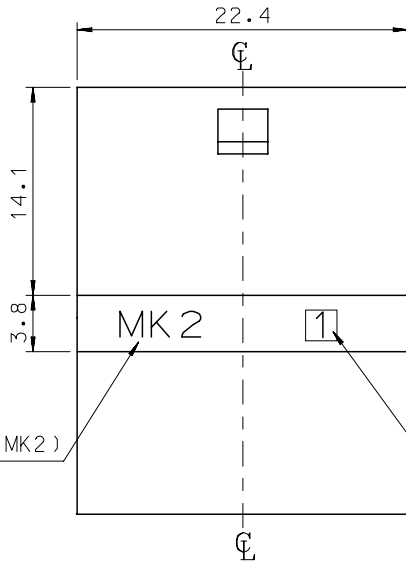
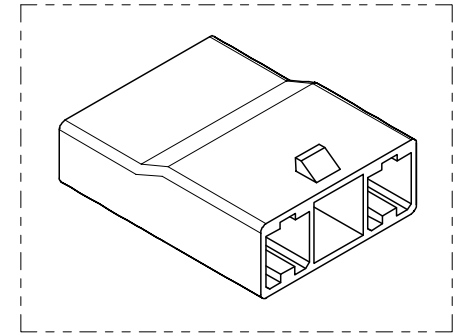

LOGO(MK2) CAVITY NO. (1,2,3,...)

CIRCUIT NO.

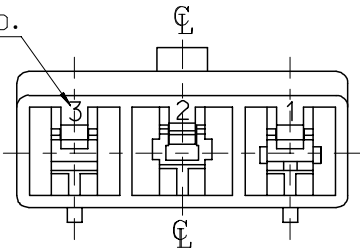

NO	PRODUCT		MATERIAL	
	PART NO	MATERIAL NO	COLOR	DESCRIPTION
1	35150-0300	351500300	NATURAL	PBT
2	35150-0304	351500304	BLUE	(UL94V-0)
3	35150-0309	351500309	NATURAL	PBT/PC
4	35150-3309	351503309	YELLOW	(UL94V-0)

REVISED
EC NO: KOR2008-0078
DRWN: JHPARK01 2007/09/10
CHKD: WY. YANG 2007/09/10
APPR: YUNSIKKIM 2007/09/10

QUALITY SYMBOLS
▽=0
▽=0

GENERAL TOLERANCES (UNLESS SPECIFIED)

	mm	INCH
4 PLACES	± ---	± ---
3 PLACES	± ---	± ---
2 PLACES	± ---	± ---
1 PLACE	± 0.3	± ---
ANGULAR ± 1 °		

DRAFT WHERE APPLICABLE MUST REMAIN WITHIN DIMENSIONS

DIMENSION STYLE
MM ONLY

DRAWN BY JS.KANG DATE 1995/12/11
CHECKED BY BK. CHOI DATE 1995/12/11
APPROVED BY CW. LEE DATE 1995/12/11

MATERIAL NO. SEE TABLE

SIZE A3

SCALE 3:1
DESIGN UNITS METRIC
THIRD ANGLE PROJECTION

7.3 PITCH W/W CONN
MALE HSG-3P(W/O EAR)

MOLEX MOLEX INCORPORATED

DOCUMENT NO. SD-35150-030* SHEET NO. 1 OF 01

THIS DRAWING CONTAINS INFORMATION THAT IS PROPRIETARY TO MOLEX INCORPORATED AND SHOULD NOT BE USED WITHOUT WRITTEN PERMISSION

9 8 7 6 5 4 3 2 1