

**Three level inverter  
Trench + Field Stop IGBT  
Power Module**

**$V_{CES} = 600V$   
 $I_C = 300A @ T_c = 80^\circ C$**

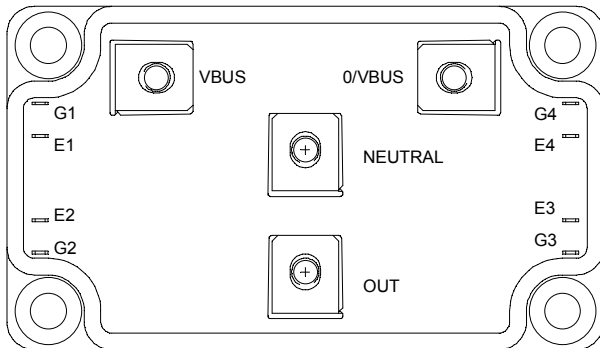
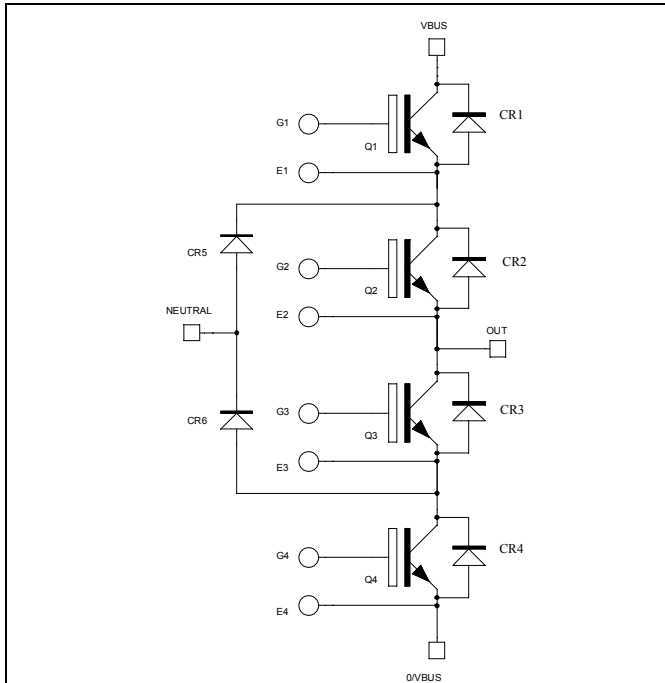

### Application

- Solar converter
- Uninterruptible Power Supplies

### Features

- Trench + Field Stop IGBT Technology
  - Low voltage drop
  - Low tail current
  - Switching frequency up to 20 kHz
  - Soft recovery parallel diodes
  - Low diode VF
  - Low leakage current
  - RBSOA and SCSOA rated
- Kelvin emitter for easy drive
- Very low stray inductance
  - Symmetrical design
  - M5 power connectors
- High level of integration

### Benefits

- Stable temperature behavior
- Very rugged
- Direct mounting to heatsink (isolated package)
- Low junction to case thermal resistance
- Easy paralleling due to positive TC of VCEsat
- Low profile
- RoHS Compliant

### Q1 to Q4 Absolute maximum ratings

Symbol	Parameter	Max ratings	Unit
$V_{CES}$	Collector - Emitter Breakdown Voltage	600	V
$I_C$	Continuous Collector Current	$T_C = 25^\circ C$	400
		$T_C = 80^\circ C$	300
$I_{CM}$	Pulsed Collector Current	$T_C = 25^\circ C$	600
$V_{GE}$	Gate - Emitter Voltage	$\pm 20$	V
$P_D$	Maximum Power Dissipation	$T_C = 25^\circ C$	935
RBSOA	Reverse Bias Safe Operating Area	$T_j = 150^\circ C$	600A @ 550V

**CAUTION:** These Devices are sensitive to Electrostatic Discharge. Proper Handling Procedures Should Be Followed. See application note APT0502 on [www.microsemi.com](http://www.microsemi.com)

All ratings @  $T_j = 25^\circ\text{C}$  unless otherwise specified

**Q1 to Q4 Electrical Characteristics**

Symbol	Characteristic	Test Conditions	Min	Typ	Max	Unit
$I_{CES}$	Zero Gate Voltage Collector Current	$V_{GE} = 0V, V_{CE} = 600V$			350	$\mu\text{A}$
$V_{CE(sat)}$	Collector Emitter Saturation Voltage	$V_{GE} = 15V$ $I_C = 300A$		1.5 1.7	1.9	V
		$T_j = 25^\circ\text{C}$ $T_j = 150^\circ\text{C}$				
$V_{GE(th)}$	Gate Threshold Voltage	$V_{GE} = V_{CE}, I_C = 5\text{ mA}$	5.0	5.8	6.5	V
$I_{GES}$	Gate – Emitter Leakage Current	$V_{GE} = 20V, V_{CE} = 0V$			800	nA

**Q1 to Q4 Dynamic Characteristics**

Symbol	Characteristic	Test Conditions	Min	Typ	Max	Unit
$C_{ies}$	Input Capacitance	$V_{GE} = 0V$		18.4		nF
$C_{oes}$	Output Capacitance	$V_{CE} = 25V$		1.16		
$C_{res}$	Reverse Transfer Capacitance	$f = 1\text{MHz}$		0.54		
$Q_G$	Gate charge	$V_{GE} = \pm 15V, I_C = 300A$ $V_{CE} = 300V$		3.2		$\mu\text{C}$
$T_{d(on)}$	Turn-on Delay Time	Inductive Switching ( $25^\circ\text{C}$ ) $V_{GE} = \pm 15V$ $V_{Bus} = 300V$ $I_C = 300A$ $R_G = 2.2\Omega$		115		ns
$T_r$	Rise Time			45		
$T_{d(off)}$	Turn-off Delay Time			225		
$T_f$	Fall Time			55		
$T_{d(on)}$	Turn-on Delay Time	Inductive Switching ( $150^\circ\text{C}$ ) $V_{GE} = \pm 15V$ $V_{Bus} = 300V$ $I_C = 300A$ $R_G = 2.2\Omega$		130		ns
$T_r$	Rise Time			50		
$T_{d(off)}$	Turn-off Delay Time			300		
$T_f$	Fall Time			70		
$E_{on}$	Turn on Energy	$V_{GE} = \pm 15V$ $V_{Bus} = 300V$		1.7 3		mJ
		$T_j = 25^\circ\text{C}$ $T_j = 150^\circ\text{C}$				
$E_{off}$	Turn off Energy	$I_C = 300A$ $R_G = 2.2\Omega$		8.2 10.6		mJ
		$T_j = 25^\circ\text{C}$ $T_j = 150^\circ\text{C}$				
$I_{sc}$	Short Circuit data	$V_{GE} \leq 15V ; V_{Bus} = 360V$ $t_p \leq 6\mu\text{s} ; T_j = 150^\circ\text{C}$		1500		A
$R_{thJC}$	Junction to Case Thermal Resistance				0.16	$^\circ\text{C/W}$

**CR1 to CR4 diode ratings and characteristics**

<i>Symbol</i>	<i>Characteristic</i>	<i>Test Conditions</i>		<i>Min</i>	<i>Typ</i>	<i>Max</i>	<i>Unit</i>
V <sub>RRM</sub>	Maximum Peak Repetitive Reverse Voltage			600			V
I <sub>RM</sub>	Maximum Reverse Leakage Current	V <sub>R</sub> =600V	T <sub>j</sub> = 25°C T <sub>j</sub> = 150°C			150 400	μA
I <sub>F</sub>	DC Forward Current		T <sub>c</sub> = 80°C		200		A
V <sub>F</sub>	Diode Forward Voltage	I <sub>F</sub> = 200A V <sub>GE</sub> = 0V	T <sub>j</sub> = 25°C T <sub>j</sub> = 150°C		1.6 1.5	2	V
t <sub>rr</sub>	Reverse Recovery Time	I <sub>F</sub> = 200A V <sub>R</sub> = 300V di/dt = 2800A/μs	T <sub>j</sub> = 25°C T <sub>j</sub> = 150°C		125 220		ns
Q <sub>rr</sub>	Reverse Recovery Charge		T <sub>j</sub> = 25°C T <sub>j</sub> = 150°C		9.4 19.8		μC
E <sub>rr</sub>	Reverse Recovery Energy		T <sub>j</sub> = 25°C T <sub>j</sub> = 150°C		2.2 4.8		mJ
R <sub>thJC</sub>	Junction to Case Thermal Resistance					0.39	°C/W

**CR5 & CR6 diode ratings and characteristics**

<i>Symbol</i>	<i>Characteristic</i>	<i>Test Conditions</i>		<i>Min</i>	<i>Typ</i>	<i>Max</i>	<i>Unit</i>
V <sub>RRM</sub>	Maximum Peak Repetitive Reverse Voltage			600			V
I <sub>RM</sub>	Maximum Reverse Leakage Current	V <sub>R</sub> =600V	T <sub>j</sub> = 25°C T <sub>j</sub> = 150°C			150 400	μA
I <sub>F</sub>	DC Forward Current		T <sub>c</sub> = 80°C		300		A
V <sub>F</sub>	Diode Forward Voltage	I <sub>F</sub> = 300A V <sub>GE</sub> = 0V	T <sub>j</sub> = 25°C T <sub>j</sub> = 150°C		1.6 1.5	2	V
t <sub>rr</sub>	Reverse Recovery Time	I <sub>F</sub> = 300A V <sub>R</sub> = 300V di/dt = 4000A/μs	T <sub>j</sub> = 25°C T <sub>j</sub> = 150°C		130 225		ns
Q <sub>rr</sub>	Reverse Recovery Charge		T <sub>j</sub> = 25°C T <sub>j</sub> = 150°C		13.7 29		μC
E <sub>rr</sub>	Reverse Recovery Energy		T <sub>j</sub> = 25°C T <sub>j</sub> = 150°C		3.2 7		mJ
R <sub>thJC</sub>	Junction to Case Thermal Resistance					0.29	°C/W

**Thermal and package characteristics**

<i>Symbol</i>	<i>Characteristic</i>	<i>Min</i>	<i>Typ</i>	<i>Max</i>	<i>Unit</i>	
V <sub>ISOL</sub>	RMS Isolation Voltage, any terminal to case t = 1 min, I <sub>isol</sub> < 1mA, 50/60Hz	2500			V	
T <sub>J</sub>	Operating junction temperature range	-40		175	°C	
T <sub>STG</sub>	Storage Temperature Range	-40		125		
T <sub>C</sub>	Operating Case Temperature	-40		100		
Torque	Mounting torque	To heatsink	M6	3	5	N.m
		For terminals	M5	2	3.5	
Wt	Package Weight				280	g



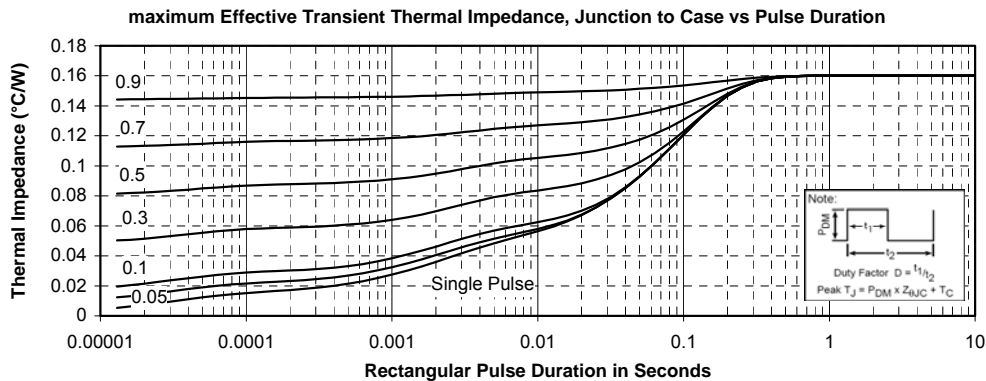
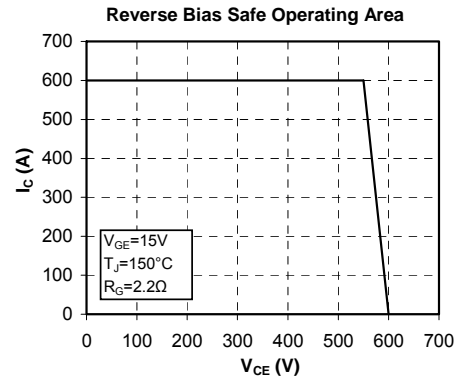
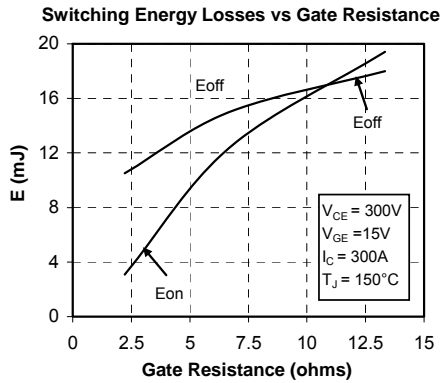
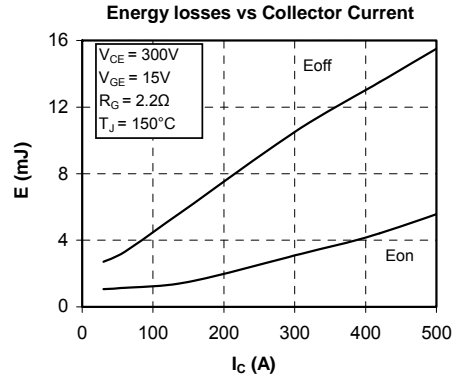
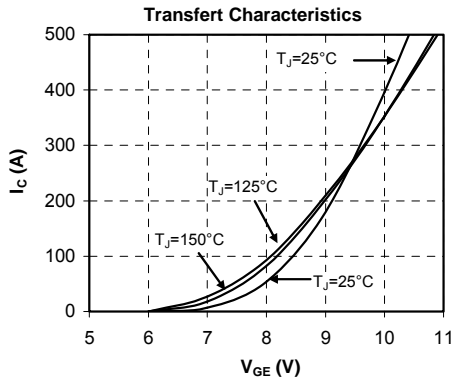
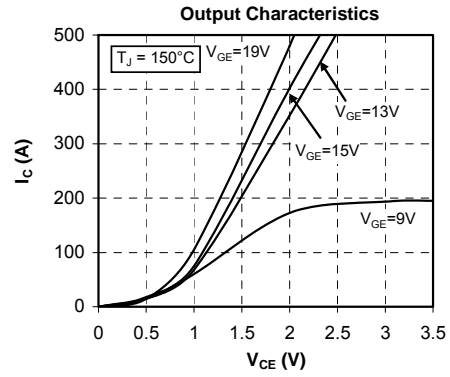
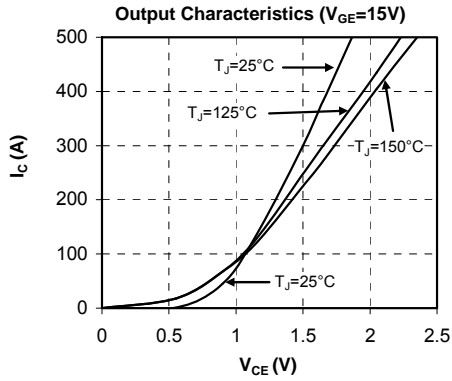

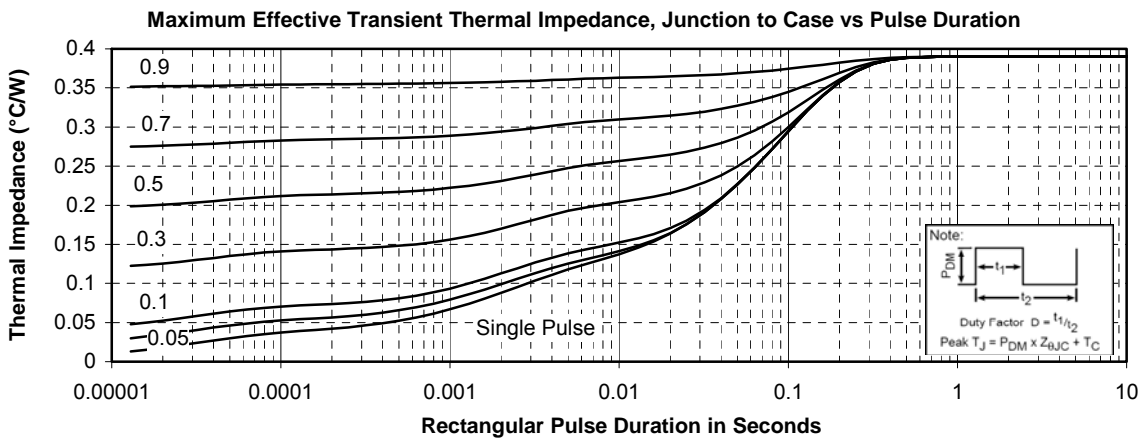
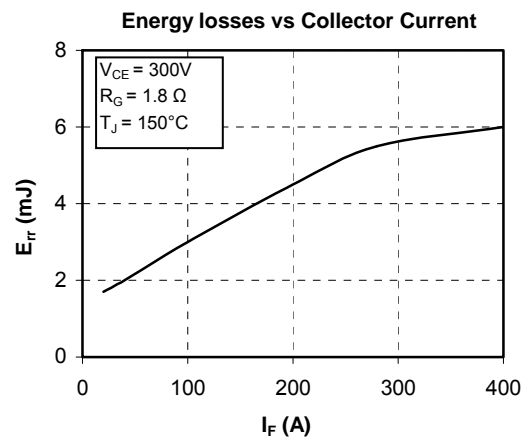
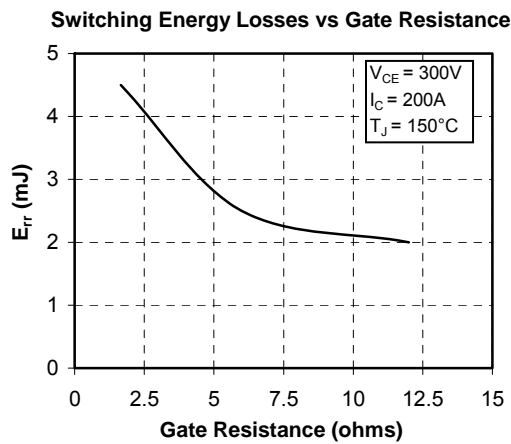
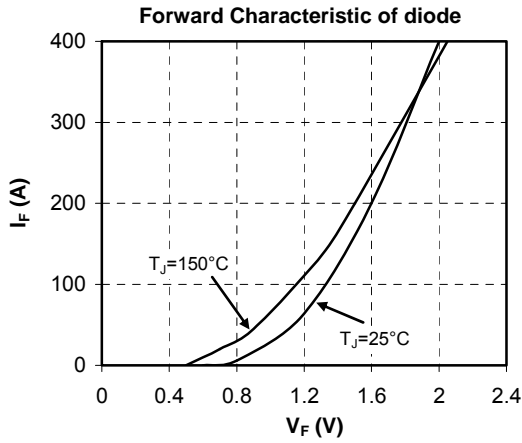
**CR1 to CR4 Typical performance curve**

## CR5 & CR6 Typical performance curve

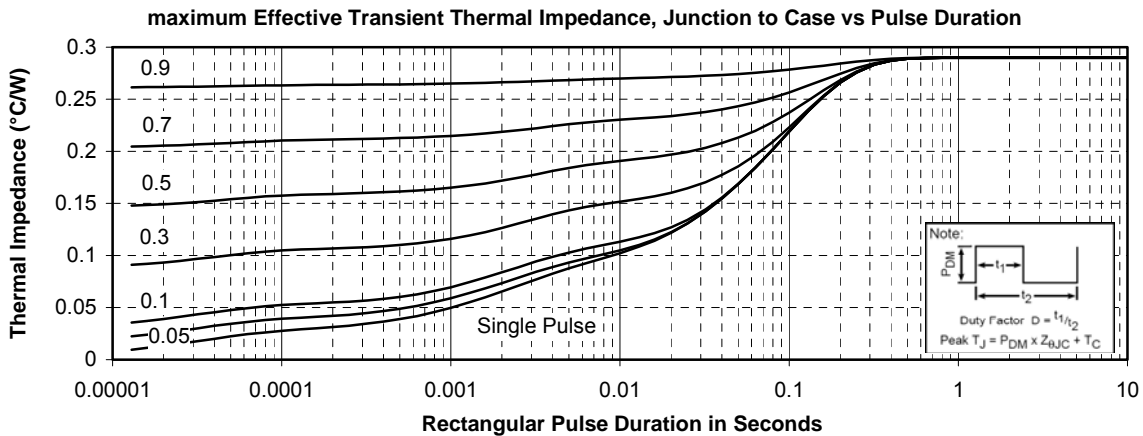
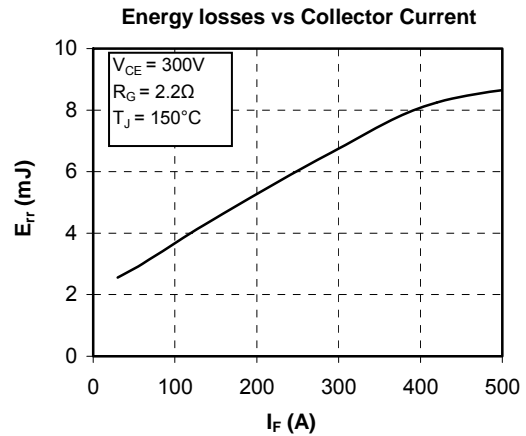
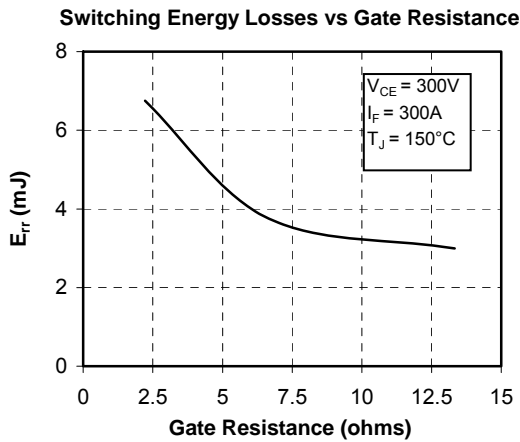
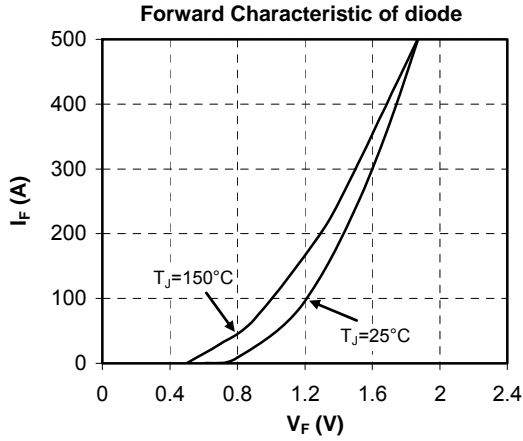

Microsemi reserves the right to change, without notice, the specifications and information contained herein

Microsemi's products are covered by one or more of U.S. patents 4,895,810 5,045,903 5,089,434 5,182,234 5,019,522 5,262,336 6,503,786 5,256,583 4,748,103 5,283,202 5,231,474 5,434,095 5,528,058 6,939,743 7,352,045 5,283,201 5,801,417 5,648,283 7,196,634 6,664,594 7,157,886 6,939,743 7,342,262 and foreign patents. U.S and Foreign patents pending. All Rights Reserved.