



Parameter	Rating	Units
Blocking Voltage	60	V _p
Load Current	400	mA
Max On-resistance	2	Ω
LED Current to operate	2	mA

Features

- Designed for use in security systems complying with EN50130-4
- Small 8-Pin SOIC Package
- TTL/CMOS Compatible input
- Arc-Free With No Snubbing Circuits
- 1500V_{rms} Input/Output Isolation
- No EMI/RFI Generation
- Immune to radiated EM fields
- SMD Pick & Place, Wave Solderable
- Tape & Reel Version Available

Applications

- Security
 - Passive Infrared Detectors (PIR)
 - Data Signalling
 - Sensor Circuitry
- Instrumentation
 - Multiplexers
 - Data Acquisition
 - Electronic Switching
 - I/O Subsystems
- Medical Equipment—Patient/Equipment Isolation
- Aerospace
- Industrial Controls

Description

The CPC2014N is a miniature device with two independent Form-A solid state relays in an 8-Pin SOIC package that employs optically coupled MOSFET technology to provide 1500V_{rms} of input/output isolation. The super efficient MOSFET switches and photovoltaic die use Clare's patented OptoMOS architecture. The optically coupled outputs are controlled by highly efficient GaAIAs infrared LEDs. The CPC2014N uses Clare's state of the art, double-molded vertical construction packaging to produce one of the world's smallest relays. The CPC2014N offers substantial board space savings over the competitor's larger 8-Pin SOIC relay.

Approvals

- UL Recognized Component: Pending
- EN/IEC 60950-1: Pending
- CSA Certified Component: Pending

Ordering Information

Part #	Description
CPC2014N	8-Pin SOIC (50/tube)
CPC2014NTR	8-Pin SOIC (2000/reel)

Pin Configuration

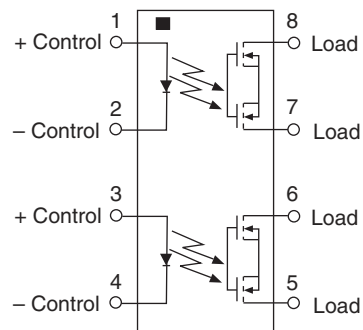

Switching Characteristics of Normally Open (Form A) Devices

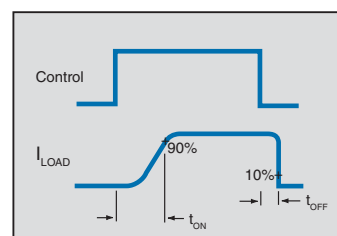

Absolute Maximum Ratings (@ 25°C)

Parameter	Ratings	Units
Blocking Voltage	60	V _P
Reverse Input Voltage	5	V
Input Control Current Peak (10ms)	50	mA
	1	A
Input Power Dissipation	70	mW
Total Power Dissipation ¹	600	mW
Isolation Voltage, Input to Output	1500	V _{rms}
Operational Temperature	-40 to +85	°C
Storage Temperature	-40 to +125	°C

¹ Derate Linearly 5.0 mW / °C

Absolute Maximum Ratings are stress ratings. Stresses in excess of these ratings can cause permanent damage to the device. Functional operation of the device at conditions beyond those indicated in the operational sections of this data sheet is not implied.

Electrical Characteristics

Parameter	Conditions	Symbol	Min	Typ	Max	Units
Output Characteristics @ 25°C						
Load Current	I _F =2mA	I _L	-	-	400	mA
Peak	t ≤ 10ms	I _{LPK}	-	-	1	A _P
On-Resistance ²	I _L =400mA	R _{ON}	-	-	2	Ω
Off-State Leakage Current	V _L =60V _P	I _{LEAK}	-	-	1	μA
Switching Speeds						
Turn-On	I _F =5mA, V _L =10V	t _{ON}	-	0.47	2	ms
Turn-Off		t _{OFF}	-	0.22	1	
Output Capacitance	50V; f=1MHz	C _{OUT}	-	40	-	pF
Capacitance Input to Output	-	-	-	1	-	pF
Input Characteristics @ 25°C						
Input Control Current ³	I _L =400mA	I _F	-	0.25	2	mA
Input Dropout Current	-	I _F	0.1	0.2	-	mA
Input Voltage Drop	I _F =5mA	V _F	0.9	1.2	1.4	V
Reverse Input Current	V _R =5V	I _R	-	-	10	μA

¹ Load current derates linearly from 400mA @ 25°C to 200mA @ 80°C, and must be derated for both poles operating simultaneously.

² Measurement taken within 1 second of on time.

³ For applications requiring high temperature operation (greater than 60°C) an LED drive current of 4mA is recommended.

PERFORMANCE DATA*

Typical LED Forward Voltage Drop
(N=50, T_A=25°C, I_F=5mA)

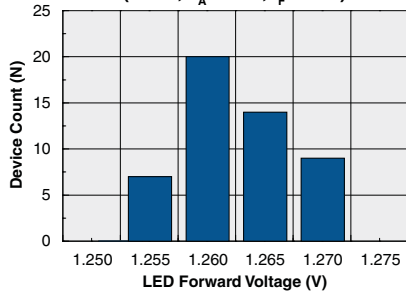

Typical On-Resistance Distribution
(N=50, T_A=25°C, I_L=400mA, I_F=1mA)

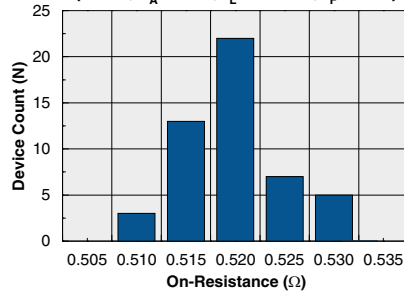

Typical Blocking Voltage Distribution
(N=50, T_A=25°C)

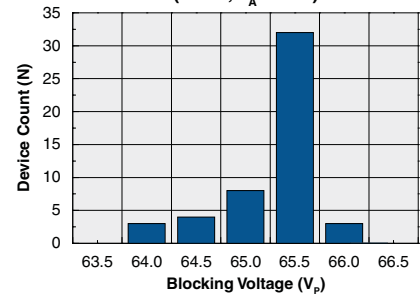

Typical I_F for Switch Operation
(N=50, T_A=25°C, I_L=400mA)

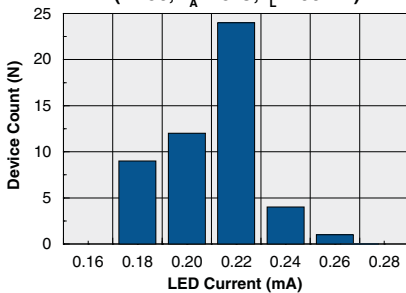

Typical I_F for Switch Dropout
(N=50, T_A=25°C, I_L=400mA)

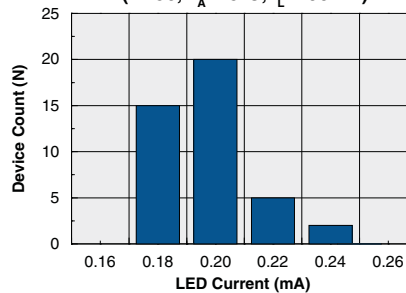

Typical Turn-On Time
(N=50, T_A=25°C, I_L=100mA, I_F=5mA)

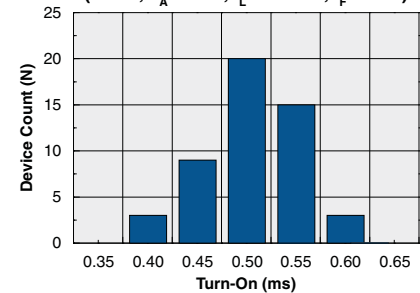

Typical Turn-Off Time
(N=50, T_A=25°C, I_L=100mA, I_F=5mA)

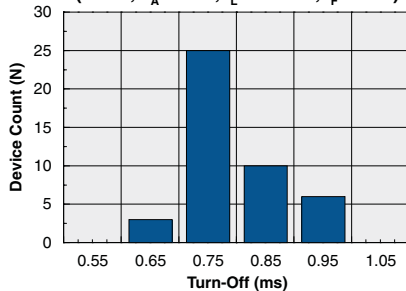

Maximum Load Current vs. Temperature with One Pole Operating
(I_F=2mA)

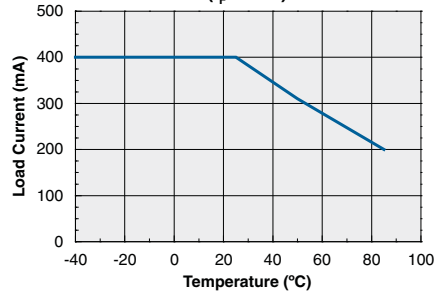

Typical Leakage vs. Temperature Measured Across Pins 5&6 and 7&8
(V_L=60V)

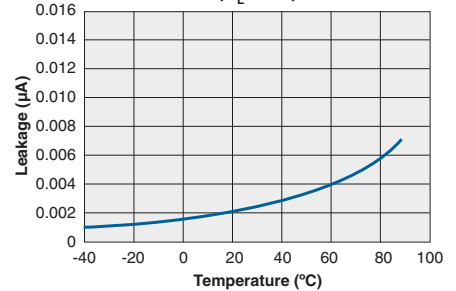

Typical Blocking Voltage vs. Temperature

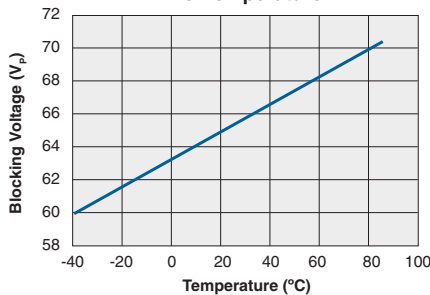

Typical Turn-On vs. Temperature
(I_L=80mA)

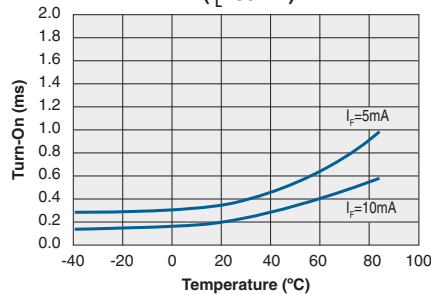

Typical Turn-Off vs. Temperature
(I_L=80mA)

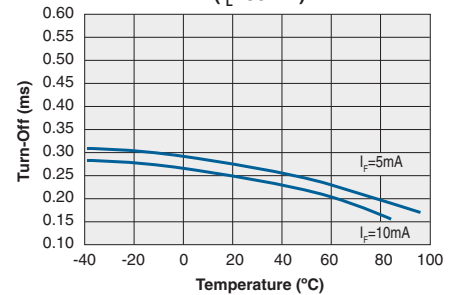

*The Performance data shown in the graphs above is typical of device performance. For guaranteed parameters not indicated in the written specifications, please contact our application department.

PERFORMANCE DATA*

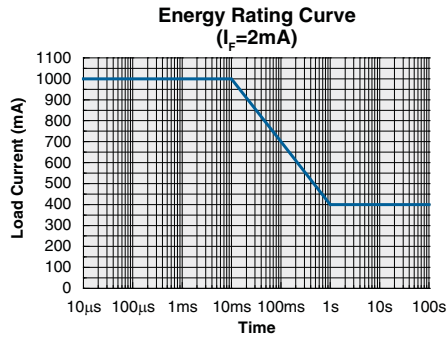
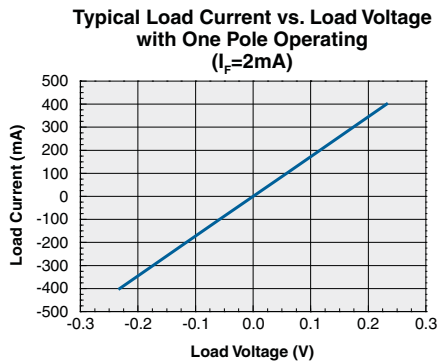
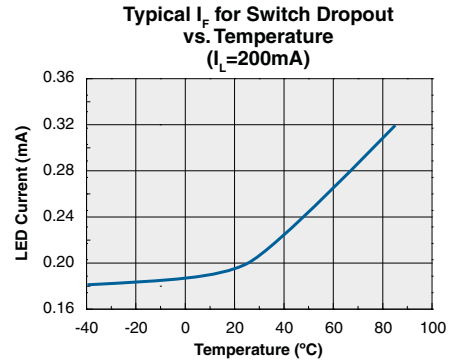
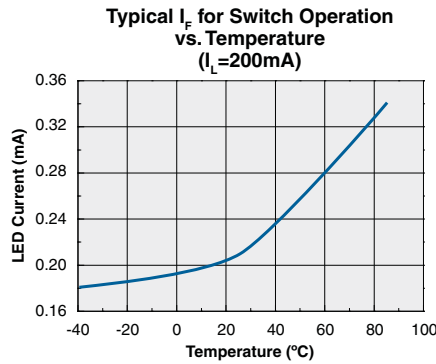
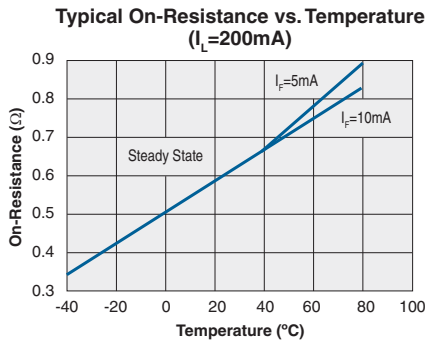
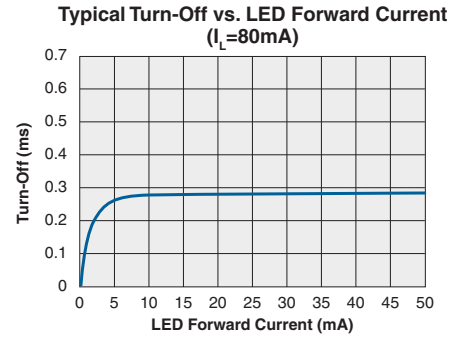
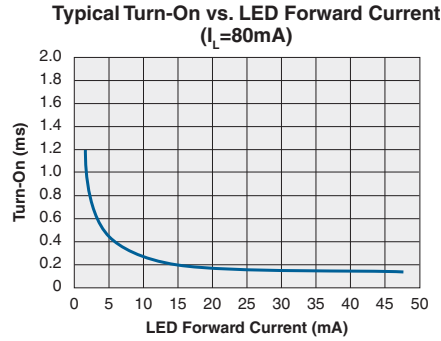
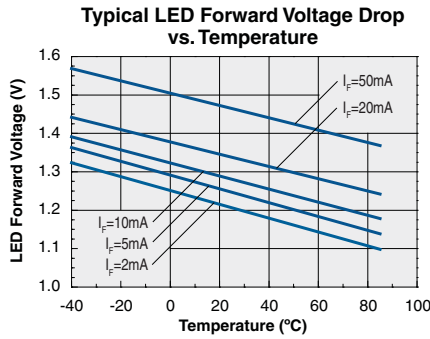

*The Performance data shown in the graphs above is typical of device performance. For guaranteed parameters not indicated in the written specifications, please contact our application department.

MANUFACTURING INFORMATION

Moisture Sensitivity

Clare has characterized the moisture reflow sensitivity of this package, and has determined that this component must be handled in accordance with IPC/JEDEC standard J-STD-033 moisture sensitivity level (MSL), level 3 classification.

Soldering Reflow Profile

For proper assembly, the component must be processed in accordance with the current revision of IPC/JEDEC standard J-STD-020. Failure to follow the recommended guidelines may cause permanent damage to the device resulting in impaired performance and/or a reduced lifetime expectancy.



Washing

Clare does not recommend ultrasonic cleaning or the use of chlorinated solvents.

MECHANICAL DIMENSIONS

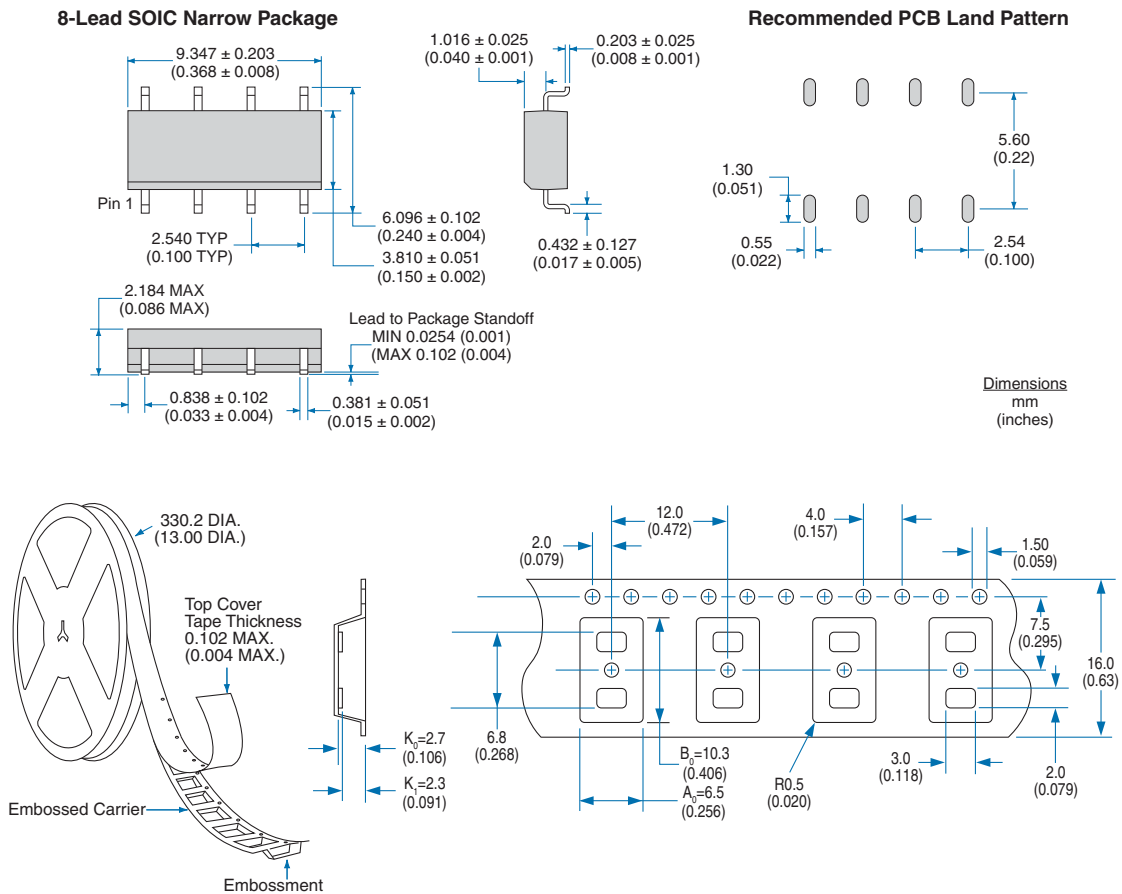

For additional information please visit our website at: www.clare.com

Clare, Inc. makes no representations or warranties with respect to the accuracy or completeness of the contents of this publication and reserves the right to make changes to specifications and product descriptions at any time without notice. Neither circuit patent licenses nor indemnity are expressed or implied. Except as set forth in Clare's Standard Terms and Conditions of Sale, Clare, Inc. assumes no liability whatsoever, and disclaims any express or implied warranty, relating to its products including, but not limited to, the implied warranty of merchantability, fitness for a particular purpose, or infringement of any intellectual property right.

The products described in this document are not designed, intended, authorized or warranted for use as components in systems intended for surgical implant into the body, or in other applications intended to support or sustain life, or where malfunction of Clare's product may result in direct physical harm, injury, or death to a person or severe property or environmental damage. Clare, Inc. reserves the right to discontinue or make changes to its products at any time without notice.