

PLEASE CHECK WWW.MOLEX.COM FOR LATEST PART INFORMATION

Part Number: [0473001001](#)

Status: **Active**

Overview: [slimline serial ata odd connectors](#)

Description: 1.00mm(.039"), 1.27mm (.050") Pitch Slimline Serial ATA Plug for Optical Disk Drive with Standard Type Screw, Right Angle, Gold (Au) Flash Plating, Phosphor Bronze Matt Tin Plated Screw Nail, with Pegs, Lead-free

Documents:

[3D Model](#)

[Product Specification PS-47300-001 \(PDF\)](#)

[Drawing \(PDF\)](#)

[RoHS Certificate of Compliance \(PDF\)](#)

Agency Certification

CSA LR 19980

General

Product Family	PCB Headers
Series	47300
Application	Board-to-Board
Comments	Screw Type
Overview	slimline serial ata odd connectors
Product Name	Serial ATA, Slimline Serial ATA

Physical

Breakaway	No
Circuits (Loaded)	13
Circuits (maximum)	13
Durability (mating cycles max)	500
First Mate / Last Break	Yes
Flammability	94V-0
Glow-Wire Compliant	No
Guide to Mating Part	Yes
Keying to Mating Part	Yes
Lock to Mating Part	No
Material - Plating Mating	Gold
Material - Plating Termination	Tin
Material - Resin	High Temperature Thermoplastic
Number of Rows	1
Orientation	Right Angle
PCB Locator	Yes
PCB Retention	Yes
Packaging Type	Embossed Tape on Reel
Pitch - Mating Interface (in)	0.039 In, 0.050 In
Pitch - Mating Interface (mm)	1.00 mm, 1.27 mm
Pitch - Term. Interface (in)	0.039 In, 0.050 In
Pitch - Term. Interface (mm)	1.00 mm, 1.27 mm
Plating min: Mating (µin)	2
Plating min: Mating (µm)	0.05
Plating min: Termination (µin)	39
Plating min: Termination (µm)	1
Polarized to Mating Part	Yes
Polarized to PCB	Yes
Stackable	No
Temperature Range - Operating	-35°C to +85°C
Termination Interface: Style	Surface Mount

Electrical

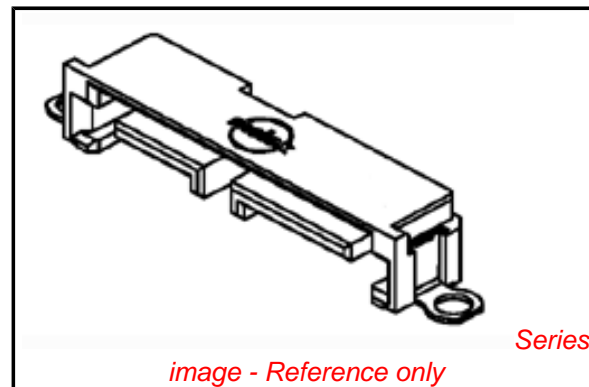

image - Reference only

EU RoHS

ELV and RoHS Compliant

REACH SVHC

Not Reviewed

Halogen-Free

Status

Halogen-Free

China RoHS



Need more information on product environmental compliance?

Email productcompliance@molex.com
For a multiple part number RoHS Certificate of Compliance, [click here](#)

Please visit the [Contact Us](#) section for any non-product compliance questions.

Search Parts in this Series

[47300Series](#)

Mates With

[47628](#) , [47639](#), [47645](#), [47650](#), [78380](#),
[48321](#), [48325](#), [48330](#), [48336](#), [47657](#)
Slimline Serial ATA Receptacles

Current - Maximum per Contact	1.5A
Voltage - Maximum	15V DC

Material Info

Reference - Drawing Numbers

Packaging Specification	PK-47300-001
Product Specification	PS-47300-001
Sales Drawing	SD-47300-100

This document was generated on 05/26/2010

PLEASE CHECK WWW.MOLEX.COM FOR LATEST PART INFORMATION

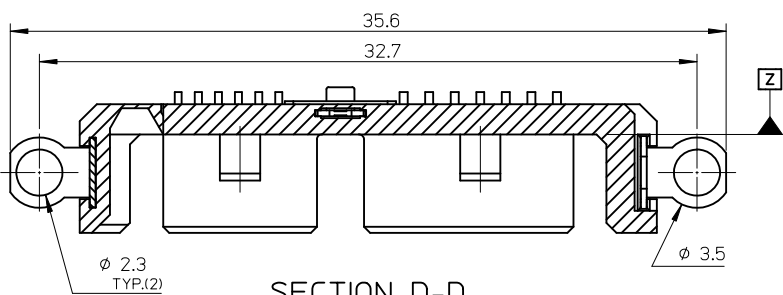

SECTION D-D

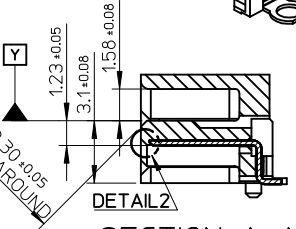
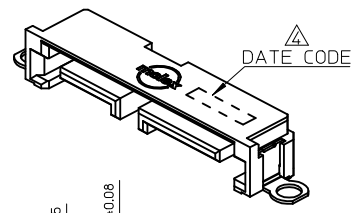

SECTION A-A

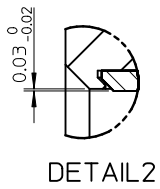
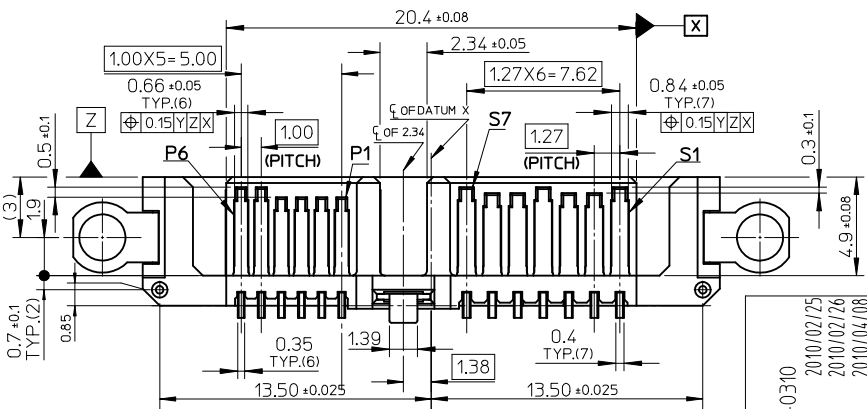
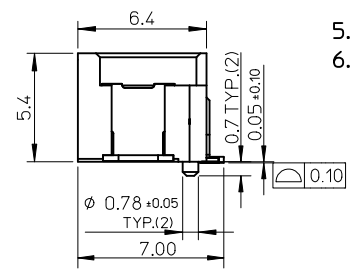
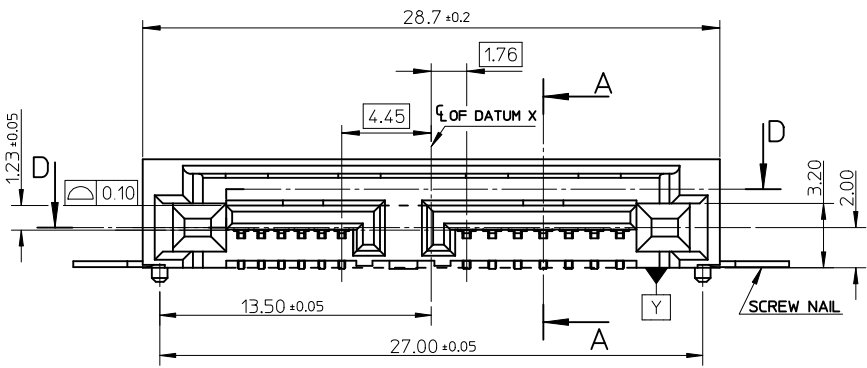

DETAIL2

NOTES :

- 1.MATERIAL :
HOUSING : HIGH TEMPERATURE THERMOPLASTIC, 30% G.F., UL94V-0, BLACK
TERMINAL : COPPER ALLOY, THICKNESS=0.25 MM
SCREW NAIL : STAINLESS, THICKNESS=0.30 MM
SOLDERING NAIL : COPPER ALLOY, THICKNESS=0.30 MM
- 2.PLATING :
TERMINAL :
CONTACT AREA : GOLD PLATING 0.1 MICRONS MIN.
SOLDERING AREA : MATTE TIN PLATING 1.0 MICRONS MIN.
UNDERPLATING : NICKEL PLATING 2.5 MICRONS MIN.
SOLDERING NAIL : MATTE TIN PLATING 1.0 MICRONS MIN.
OVER NICKEL PLATING 1.0 MICRONS MIN.
- 3.PRODUCT SPECIFICATION: PS-47300-001.
- DATE CODE FORMAT: YY/MM/DD/XX/S, 'XX' IS USED TO MARK TERMINAL GOLD PLATING SPEC, '05' IS FOR FLSH, '15' IS FOR 15u", '30' IS FOR 30u". 'S' IS A SPECIAL LETTER FOR FACTORY TO TRACK.
- 5.PRODUCT PACKAGE SPEC: PK-47300-001.
- 6.THE PRODUCT COMPLIANT TO RoSH DIRECTIVE 2002/95/EC AND ELV DIRECTIVE 2000/53/EC.

P/N	CONTACT PLATING	NAIL
47300-1000	GOLD FLASH	
47300-1002	GOLD 0.38 MICRONS MIN	STAINLESS STEEL, NO PLATING
47300-1004	GOLD 0.76 MICRONS MIN	
47300-1001	GOLD FLASH	
47300-1003	GOLD 0.38 MICRONS MIN	PHOSPHOR BRONZE, MATTE TIN PLATING
47300-1005	GOLD 0.76 MICRONS MIN	

REVISED	EC NO: SH2010-0310	DRWING:GLL	CHKD:	APPR:RZHANG	DESCRIPTION	QUALITY SYMBOLS		GENERAL TOLERANCES (UNLESS SPECIFIED)		DIMENSION STYLE		SCALE		DESIGN UNITS		THIRD ANGLE PROJECTION	
						mm	INCH	MM ONLY	4:1	METRIC	THIRD ANGLE PROJECTION						
0	0	0	0	0	0	4 PLACES	± ---	± ---	DRAWN BY	DATE	TITLE						
0	0	0	0	0	0	3 PLACES	± ---	± ---	GLL1	2010/02/25	SLIMLINE SATA PLUG FOR OPTIC DISK DRIVER						
0	0	0	0	0	0	2 PLACES	± ---	± ---	CHECKED BY	DATE	SCREW STANDARD TYPE						
0	0	0	0	0	0	1 PLACE	± ---	± ---	APPROVED BY	DATE	MOLEX INCORPORATED						
ANGULAR ± 3 °						DRAFT WHERE APPLICABLE MUST REMAIN WITHIN DIMENSIONS		SEE TABLE		DOCUMENT NO.		SD-47300-100		SHEET NO.			
REVISED						SIZE		THIS DRAWING CONTAINS INFORMATION THAT IS PROPRIETARY TO MOLEX INCORPORATED AND SHOULD NOT BE USED WITHOUT WRITTEN PERMISSION									

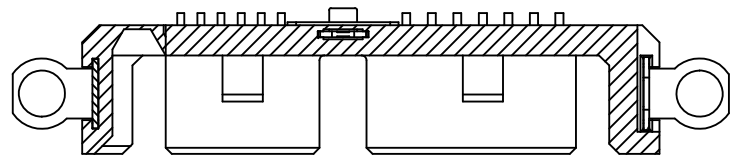

SECTION D1-D1

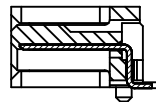

SECTION A1-A1

NOTES : OTHER DIMENSIONS AND NOTES REFER TO SHEET-1.

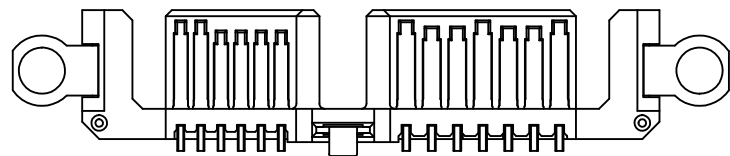
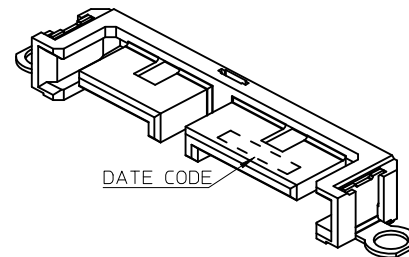
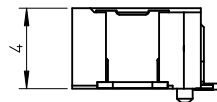
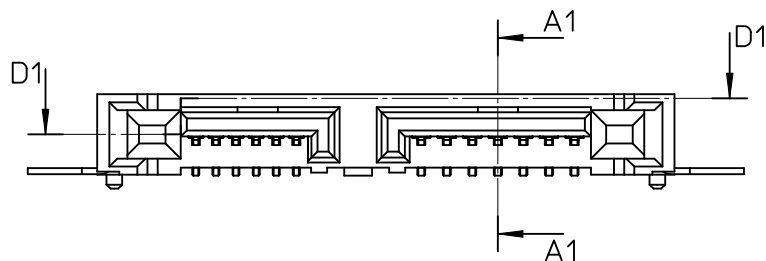

P/N	CONTACT PLATING	NAIL
47300-1014	GOLD FLASH	
47300-1012	GOLD 0.38 MICRONS MIN	STAINLESS STEEL, NO PLATING
47300-1010	GOLD 0.76 MICRONS MIN	
47300-1015	GOLD FLASH	
47300-1013	GOLD 0.38 MICRONS MIN	PHOSPHOR BRONZE, MATTE TIN PLATING
47300-1011	GOLD 0.76 MICRONS MIN	

REVISED EC NO: SH2010-0310 DRWNG: GLL1 CHKD: APPR: RZHANG REV	DESCRIPTION 2010/02/25 2010/02/26 2010/04/08	QUALITY SYMBOLS	GENERAL TOLERANCES (UNLESS SPECIFIED)	DIMENSION STYLE	SCALE	DESIGN UNITS	THIRD ANGLE PROJECTION	
		$\nabla_F=0$ $\nabla_E=0$ $\nabla_D=0$	mm INCH 4 PLACES ± --- ± --- 3 PLACES ± --- ± --- 2 PLACES ± --- ± --- 1 PLACE ± --- ± --- ANGULAR ± 3 °	MM ONLY	4:1	METRIC	DRAWN BY: GLL1 DATE: 2010/02/25 CHECKED BY: DATE:	TITLE: SLIMLINE SATA PLUG FOR OPTIC DISK DRIVER SCREW LOW TYPE MOLEX INCORPORATED
			DRAFT WHERE APPLICABLE MUST REMAIN WITHIN DIMENSIONS	SEE TABLE	APPROVED BY: RZHANG DATE: 2010/02/26 MATERIAL NO. DOCUMENT NO. SD-47300-100	SHEET NO. 2 OF 7		
				SIZE: A3 THIS DRAWING CONTAINS INFORMATION THAT IS PROPRIETARY TO MOLEX INCORPORATED AND SHOULD NOT BE USED WITHOUT WRITTEN PERMISSION				

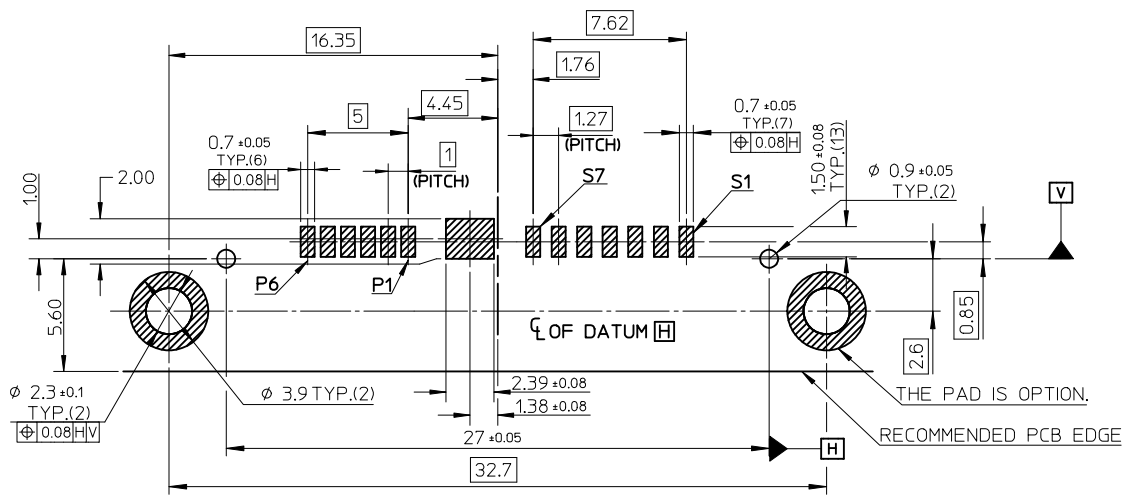

RECOMMENDED PCB LAYOUT(CONNECTOR SIDE)

THICKNESS=0.8MM

REMARK:

THE PCB LAYOUT IS ONLY FOR 47300-100X, 47300-101X.

REVISED EC NO: SH2010-0310 DRW: GLLI CHKD: APPR: RZHANG REV J	2010/02/25 2010/02/26 2010/04/08	QUALITY SYMBOLS $\nabla = 0$ $\nabla = 0$ $\nabla = 0$	GENERAL TOLERANCES (UNLESS SPECIFIED)		DIMENSION STYLE MM ONLY		SCALE 4:1	DESIGN UNITS METRIC	THIRD ANGLE PROJECTION		
			mm	INCH	DRAWN BY GLLI	DATE 2010/02/25	TITLE SLIMLINE SATA PLUG FOR OPTIC DISK DRIVER SCREW TYPE				
			4 PLACES ± --- ± ---	3 PLACES ± --- ± ---	CHECKED BY	DATE					
			2 PLACES ± --- ± ---	1 PLACE ± --- ± ---	APPROVED BY RZHANG	DATE 2010/02/26	MOLEX INCORPORATED				
		ANGULAR ± 3 °		MATERIAL NO.	DOCUMENT NO.	SD-47300-100		SHEET NO. 3 OF 7			
DRAFT WHERE APPLICABLE MUST REMAIN WITHIN DIMENSIONS				SEE REMARK		THIS DRAWING CONTAINS INFORMATION THAT IS PROPRIETARY TO MOLEX INCORPORATED AND SHOULD NOT BE USED WITHOUT WRITTEN PERMISSION					

10 9 8 7 6 5 4 3 2 1

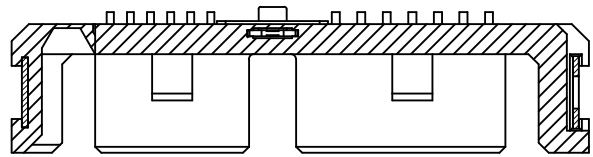

SECTION D-D

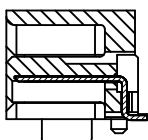

SECTION A-A

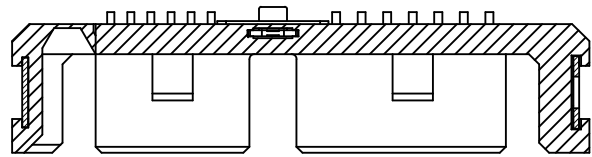

SECTION Z-Z

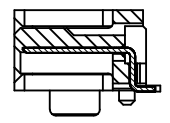

SECTION Y-Y

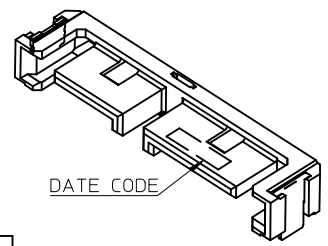
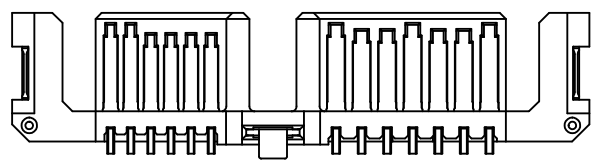
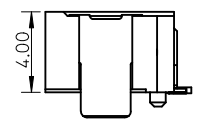
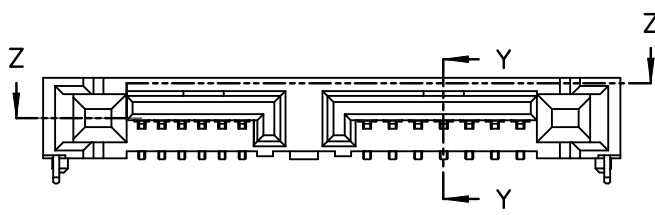
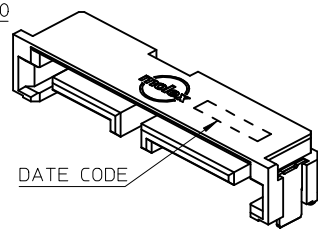
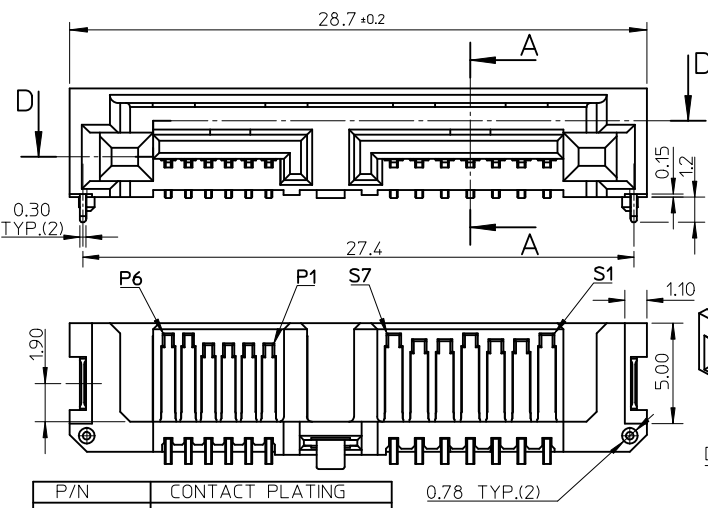

P/N	CONTACT PLATING
47300-1022	GOLD 0.76 MICRONS MIN
47300-1021	GOLD 0.38 MICRONS MIN
47300-1023	GOLD FLASH

P/N	CONTACT PLATING
47300-1032	GOLD 0.76 MICRONS MIN
47300-1031	GOLD 0.38 MICRONS MIN
47300-1030	GOLD FLASH

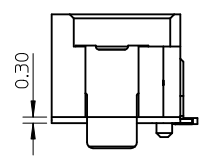
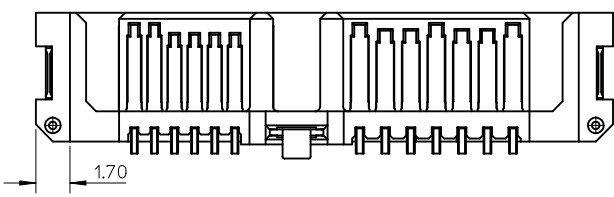

NOTES: ONLY FOR 47300-1020, OTHER DIMENSION AND NOTES REFER TO 47300-1023.

NOTES : OTHER DIMENSIONS AND NOTES REFER TO 47300-102X.

- NOTES :
- MATERIAL :
SOLDERING PEG : COPPER ALLOY
 - PLATING :
SOLDERING PEG :
MATTE TIN PLATING 1.0 MICRONS MIN.
OVER NICKEL PLATING 1.0 MICRONS MIN.
 - PRODUCT PACKAGE SPEC: PK-47300-003.
 - OTHER NOTES AND DIMENSIONS REFER TO SHEET-1.

REVISED	EC NO: SH2010-0310	2010/02/25	QUALITY SYMBOLS
	DRWG:GLL1	2010/02/26	▽F=0
	CHKD:		▽F=0
	APPR:RZHANG	2010/04/08	▽F=0
J	REV	DESCRIPTION	

GENERAL TOLERANCES (UNLESS SPECIFIED)	
	mm INCH
4 PLACES	± --- ± ---
3 PLACES	± --- ± ---
2 PLACES	± --- ± ---
1 PLACE	± --- ± ---
ANGULAR ± 3 °	
DRAFT WHERE APPLICABLE MUST REMAIN WITHIN DIMENSIONS	

DIMENSION STYLE	
MM ONLY	
DRAWN BY	DATE
GLL1	2010/02/25
CHECKED BY	DATE
APPROVED BY	DATE
RZHANG	2010/02/26
MATERIAL NO.	
SEE TABLE OR NOTES	
SIZE	
A3	

SCALE	DESIGN UNITS	THIRD ANGLE PROJECTION
4:1	METRIC	☉
TITLE		
SLIMLINE SATA PLUG FOR OPTIC DISK DRIVER		
SOLDERING STANDARD TYPE		
MOLEX INCORPORATED		
DOCUMENT NO.	SHEET NO.	
SD-47300-100	4 OF 7	
THIS DRAWING CONTAINS INFORMATION THAT IS PROPRIETARY TO MOLEX INCORPORATED AND SHOULD NOT BE USED WITHOUT WRITTEN PERMISSION		

9 8 7 6 5 4 3 2 1

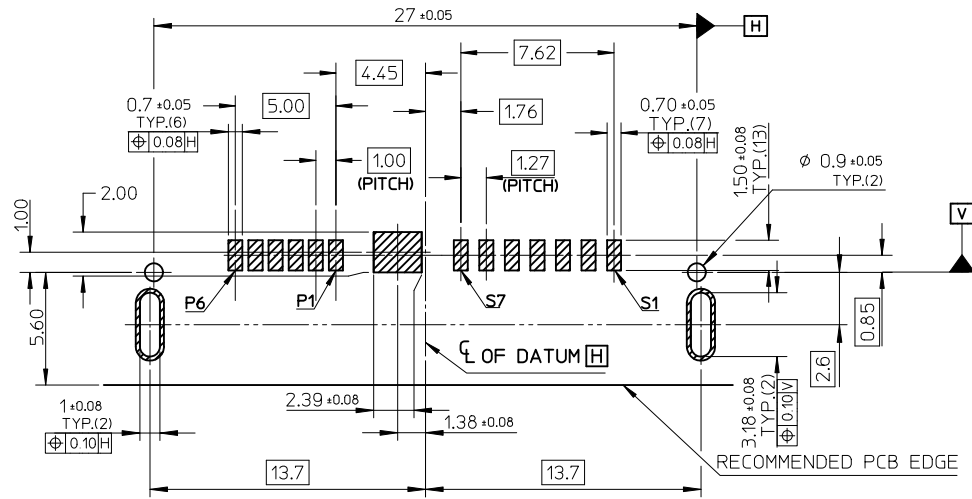

RECOMMEND PCB LAYOUT (THICKNESS=0.8)

REMARK:
THE PCB LAYOUT IS ONLY FOR 47300-102X AND 47300-103X.

REVISED EC NO: SH2010-0310 DRWNG: GLL I CHKD: RZHANG APPR: RZHANG REV	QUALITY SYMBOLS F=0 F=0 F=0	GENERAL TOLERANCES (UNLESS SPECIFIED)		DIMENSION STYLE MM ONLY	SCALE 4:1	DESIGN UNITS METRIC	THIRD ANGLE PROJECTION		
		4 PLACES ± --- ± ---	3 PLACES ± --- ± ---	2 PLACES ± --- ± ---	1 PLACE ± --- ± ---	DRAWN BY GLL I	DATE 2010/02/25	TITLE SLIMLINE SATA PLUG FOR OPTIC DISK DRIVER SOLDERING TYPE	
		ANGULAR ± 3 °		DRAFT WHERE APPLICABLE MUST REMAIN WITHIN DIMENSIONS		APPROVED BY RZHANG	DATE 2010/02/26	MOLEX INCORPORATED	
		SEE REMARK		MATERIAL NO.		DOCUMENT NO.		SHEET NO.	

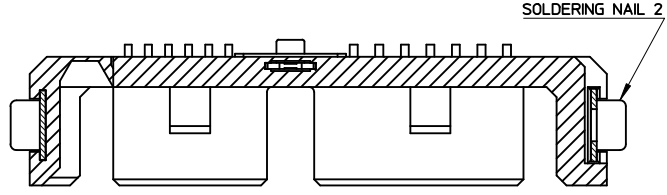

SECTION D-D

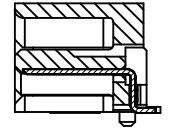

SECTION A-A

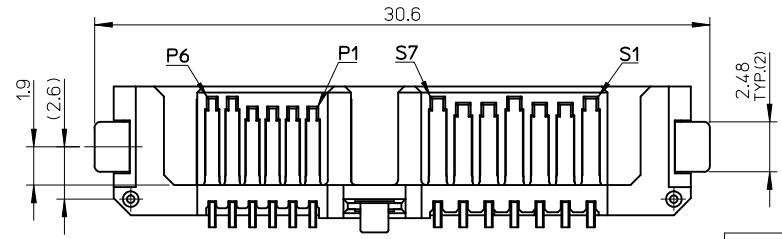
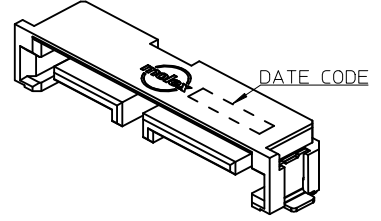
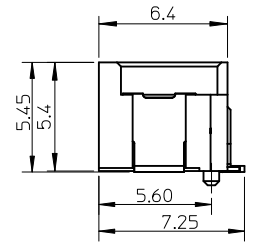
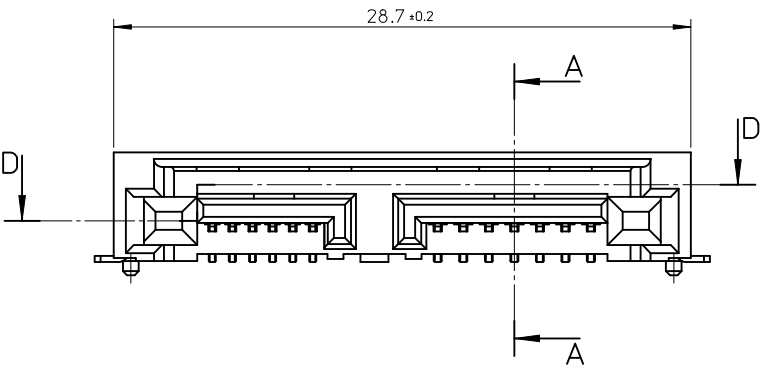

P/N	CONTACT PLATING
47300-1042	GOLD 0.76 MICRONS MIN
47300-1041	GOLD 0.38 MICRONS MIN
47300-1040	GOLD FLASH

NOTES :

- MATERIAL :
SOLDERING NAIL 2 : COPPER ALLOY
- PLATING :
SOLDERING NAIL 2 : MATTE TIN PLATING 1.0 MICRONS MIN.
OVER NICKEL PLATING 1.0 MICRONS MIN.
- OTHER NOTES AND DIMENSIONS REFER TO SHEET-1.

REVISED EC NO: SH2010-0310 DRWN:GLL 2010/02/25 CHKD: 2010/07/26 APPR:RZHANG 2010/04/08	DESCRIPTION J	QUALITY SYMBOLS	GENERAL TOLERANCES (UNLESS SPECIFIED)	DIMENSION STYLE	SCALE	DESIGN UNITS	THIRD ANGLE PROJECTION	
		$\nabla_A = 0$ $\nabla_C = 0$ $\nabla_P = 0$	mm INCH 4 PLACES ± --- ± --- 3 PLACES ± --- ± --- 2 PLACES ± --- ± --- 1 PLACE ± --- ± --- ANGULAR ± 3 °	MM ONLY	4:1	METRIC	DRAWN BY DATE GLL 2010/02/25 CHECKED BY DATE APPROVED BY DATE RZHANG 2010/02/26 MATERIAL NO.	TITLE SLIMLINE SATA PLUG FOR OPTIC DISK DRIVER FITTING STANDARD TYPE MOLEX INCORPORATED DOCUMENT NO. SD-47300-100 SHEET NO. 6 OF 7
		DRAFT WHERE APPLICABLE MUST REMAIN WITHIN DIMENSIONS	SEE TABLE	THIS DRAWING CONTAINS INFORMATION THAT IS PROPRIETARY TO MOLEX INCORPORATED AND SHOULD NOT BE USED WITHOUT WRITTEN PERMISSION				
		SIZE A3						

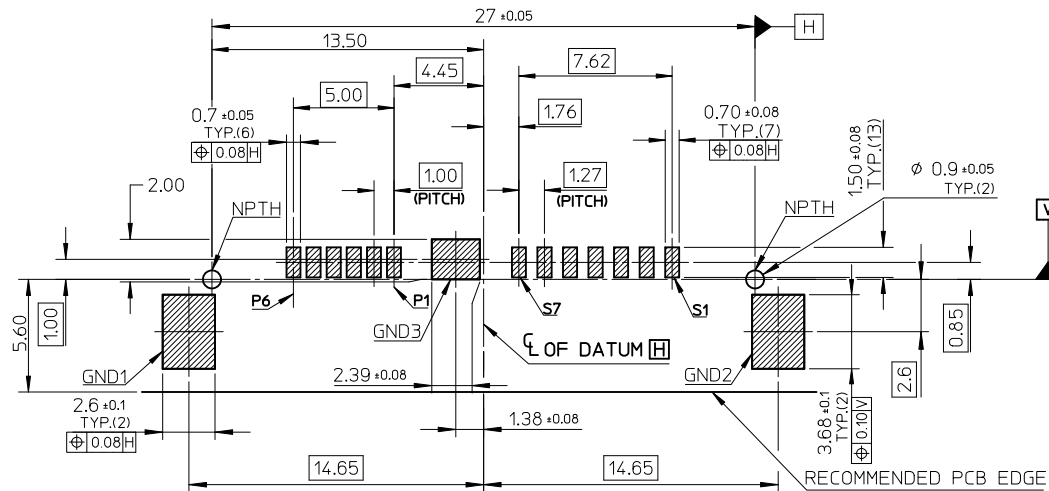

RECOMMEND PCB LAYOUT

REMARK:
THE PCB LAYOUT IS ONLY FOR 47300-104X

REVISED IEC NO: SH2010-0310 DRWG:GLL1 CHYKD: APPR:RZHANG	2010/02/25 2010/02/26 2010/04/08	QUALITY SYMBOLS $\nabla_F = 0$ $\nabla_F = 0$ $\nabla_F = 0$	GENERAL TOLERANCES (UNLESS SPECIFIED)		DIMENSION STYLE MM ONLY	SCALE 4:1	DESIGN UNITS METRIC	THIRD ANGLE PROJECTION		
			4 PLACES ± --- ± --- 3 PLACES ± --- ± --- 2 PLACES ± --- ± --- 1 PLACE ± --- ± ---	DRAWN BY: GLL1 DATE: 2010/02/25	TITLE SLIMLINE SATA PLUG FOR OPTIC DISK DRIVER FITTING TYPE					
			ANGULAR ± 3 °	CHECKED BY: DATE:	APPROVED BY: RZHANG DATE: 2010/02/26	MOLEX INCORPORATED				
			DRAFT WHERE APPLICABLE MUST REMAIN WITHIN DIMENSIONS	MATERIAL NO. SEE REMARK	DOCUMENT NO. SD-47300-100	SHEET NO. 7 OF 7				