

PLEASE CHECK WWW.MOLEX.COM FOR LATEST PART INFORMATION

Part Number: [0511911100](#)
Status: **Active**
Description: 2.50mm (.098") Pitch Wire-to-Wire and Wire-to-Board Receptacle Housing, With Guide Rails, 11 Circuits

Documents:

3D Model	Product Specification PS-51191-003 (PDF)
Drawing (PDF)	RoHS Certificate of Compliance (PDF)
Product Specification PS-51191-002 (PDF)	

Agency Certification

UL	E29179
----	--------

General

Product Family	Crimp Housings
Series	51191
Product Name	N/A

Physical

Circuits (maximum)	11
Flammability	94V-0
Gender	Female
Glow-Wire Compliant	No
Material - Resin	Nylon
Number of Rows	1
Packaging Type	Bag
Panel Mount	No
Pitch - Mating Interface (in)	0.098 In
Pitch - Mating Interface (mm)	2.50 mm
Stackable	No
Temperature Range - Operating	-40°C to +105°C

Material Info

Reference - Drawing Numbers

Product Specification	PS-51191-002, PS-51191-003, RPS-51191-007
Sales Drawing	SD-51191-004

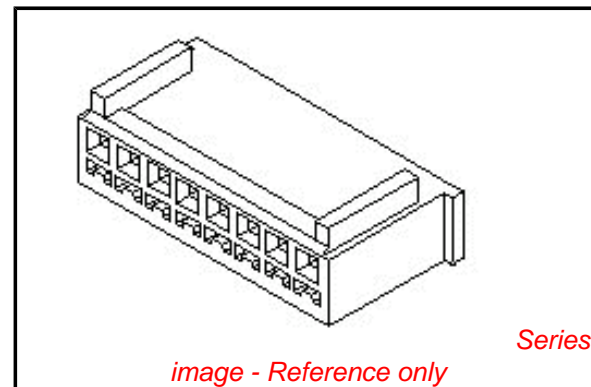

EU RoHS

ELV and RoHS Compliant
REACH SVHC Contains SVHC: No
Halogen-Free Status

China RoHS



Not Reviewed

Need more information on product environmental compliance?

Email productcompliance@molex.com
 For a multiple part number RoHS Certificate of Compliance, [click here](#)

Please visit the [Contact Us](#) section for any non-product compliance questions.

Search Parts in this Series

[51191Series](#)

Mates With

[5045](#) Vertical Header . [5046](#) Right Angle Header . [5240](#) Plug Housing

Use With

[50802](#) Crimp Terminal

PLEASE CHECK WWW.MOLEX.COM FOR LATEST PART INFORMATION

10 9 8 7 6 5 4 3 2 1

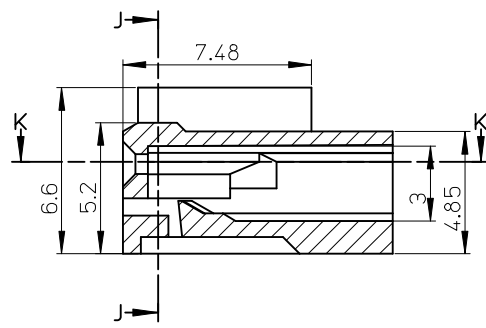
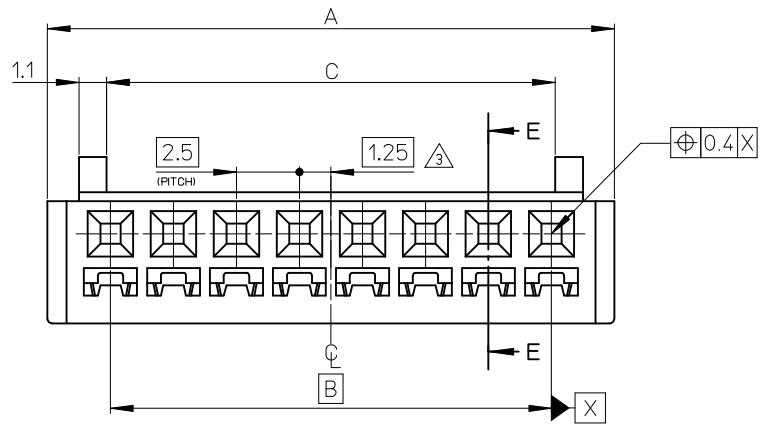

断面 E-E
SECTION E-E

NOTES: 1. 適合ターミナル : 50802-****
 APPLICABLE TERMINAL : 50802-****
 2. 嵌合相手 : 5045,5046,5240シリーズ
 MATE WITH : 5045,5046,5240 SERIES
 △ 偶数極の製品に適用
 APPLY EVEN CIRCUITS PRODUCTS

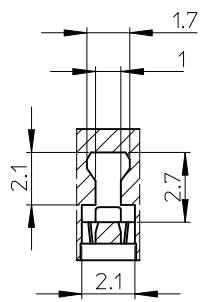
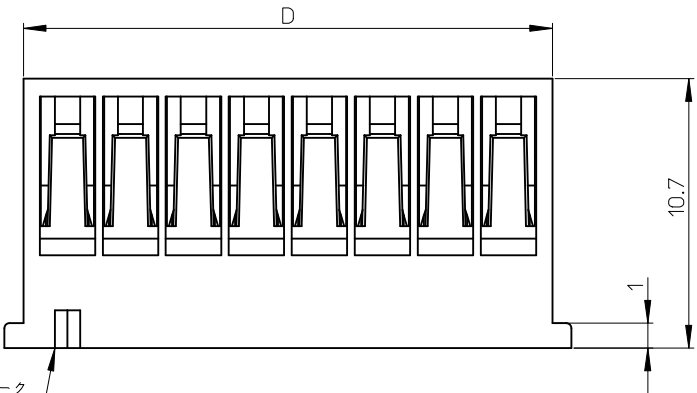

断面 J-J
SECTION J-J

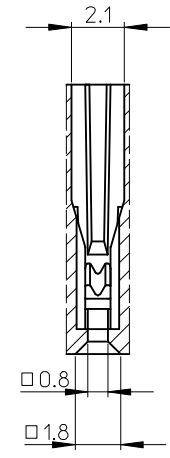

断面 K-K
SECTION K-K

回路番号1マーク
CKT.NO.1MARK

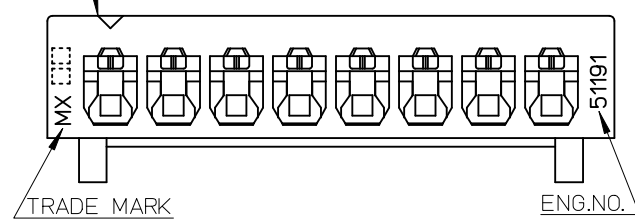

41	37.8	37.5	42.5	51191-1600	16
38.5	35.3	35	40	51191-1500	15
36	32.8	32.5	37.5	51191-1400	14
33.5	30.3	30	35	51191-1300	13
31	27.8	27.5	32.5	51191-1200	12
28.5	25.3	25	30	51191-1100	11
26	22.8	22.5	27.5	51191-1000	10
23.5	20.3	20	25	51191-0900	9
21	17.8	17.5	22.5	51191-0800	8
18.5	15.3	15	20	51191-0700	7
16	12.8	12.5	17.5	51191-0600	6
13.5	10.3	10	15	51191-0500	5
11	7.8	7.5	12.5	51191-0400	4
8.5	5.3	5	10	51191-0300	3
6	2.8	2.5	7.5	51191-0200	2
D	C	B	A	MATERIAL NO.	CKT.

材料 MATERIAL	NYLON66.JL94V-0
仕上げ FINISH	—
適用電線範囲 WIRE RANGE	—
被覆外径 INS. RANGE	—

REVISED EC NO. : J2009-1227 DRWN:YOSHIDAM 2008/12/19 CHKD:THARUYAMA 2008/12/19 APPR:NUKITA 2009/01/16	GENERAL TOLERANCES (UNLESS SPECIFIED)	
	10 UNDER	±0.2
	10 OVER 30 UNDER	±0.25
	30 OVER	±0.3
DESCRIPTION	ANGULAR ±---°	
REV	DRAFT WHERE APPLICABLE MUST REMAIN WITHIN DIMENSIONS	

DIMENSION STYLE MM ONLY	
DRAWN BY S.MATSUZAKI	DATE 1998/04/09
CHECKED BY S.KUNISHI	DATE 1998/04/10
APPROVED BY M.FUKUSHIMA	DATE 1998/04/10
MATERIAL NO.	
SIZE A3	

SCALE 5:1	DESIGN UNITS METRIC	THIRD ANGLE PROJECTION
TITLE 2.5 WIRE TO BOARD CONN. HOUSING		
MOLEX MOLEX INCORPORATED		
DOCUMENT NO. SD-51191-004	SHEET NO. 1 OF 1	
THIS DRAWING CONTAINS INFORMATION THAT IS PROPRIETARY TO MOLEX INCORPORATED AND SHOULD NOT BE USED WITHOUT WRITTEN PERMISSION		