

Shoulder 好达

SHOULDER ELECTRONICS CO., LTD.

CRYSTAL RESONATOR Data Sheet

PRODUCT 产品: CRYSTAL RESONATOR

MODEL NO 型号: TF38

PREPARED 编制: Fengyu

CHECKED 审核: York

APPROVED 批准:

DATE 日期: 2007-01-25

1. SPECIFICATION

FREQUENCY RANGE	25.000-150.000KHz
LOAD CAPACITANCE	12.5PF TYPICAL
FREQUENCY TOLERANCE AT 25°C	-/+30PPM MAXIMUM
OPERATING TEMPERATURE RANGE	-10 TO +60 °C
STORAGE TEMPERATURE RANGE	-40 TO +85 °C
EQUIVALENT SERIES RESISTANCE (ESR)	40Kohm MAXIMUM
DRIVE LEVEL	1.0 i W MAXIMUM
SHUNT CAPACITANCE	1.7PF MAXIMUM
AGING	-/+5PPM PER YEAR
INSULATION RESISTANCE	500Mohm MINIMUM

2. PART NUMBERING SYSTEM

HOLDER TYPE	FREQUENCY	LOAD CAPACITANCE	FREQUENCY TOLERANCE AT 25°C
TF38	IN KHz	6 TO 12.5PF	20 FOR -/+20PPM

OPERATING TEMPERATURE RANGE
B FOR -10 TO +60 °C

12.5PF OF LOAD CAPACITANCE NOT NEEDED IN PART NUMBER

20PPM OF FREQUENCY TOLERANCE NOT NEEDED IN PART NUMBER

-10 TO +60 °C OF OPERATING TEMPERATURE RANGE NOT NEEDED IN PART NUMBER

3. DIMENSIONS

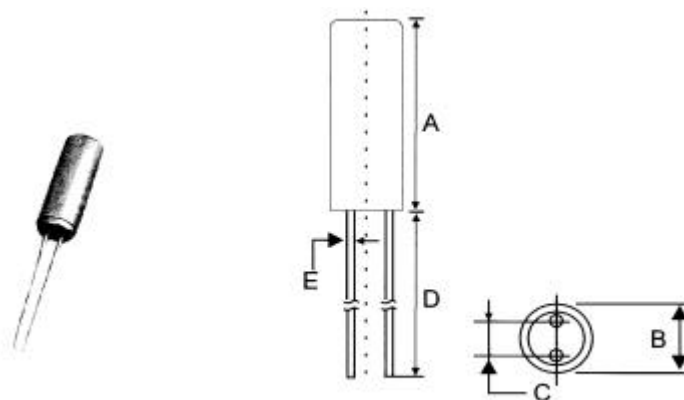

A	B	C	D	E
8.0	3.0	1.1	10.0	0.3