



Technical Data Sheet

3.0mm Round Type LED Lamps

A214B/SUBC/S400-A6

■ Features :

- Low power consumption
- High efficiency and low cost
- Good control and free combinations on the colors of LED lamps
- Good lock and easy to assembly
- Stackable and easy to assembly  
Stackable vertically and easy to assembly
- Versatile mounting on P.C board or panel
- Stackable horizontally and easy to assembly
- Pb free
- The product itself will remain within RoHS compliant version



■ Descriptions :

- ARRAY=Plastic Holder+Combinations of Lamps
- The array will easily mount the applicable lamps on any panel up to

■ Applications :

- 1.Used as indicators of indicating the Degree, Functions, Positions etc, in electronic instruments.

| PART NO.           | Chip     |               | Lens Color  |
|--------------------|----------|---------------|-------------|
|                    | Material | Emitted Color |             |
| 264-10SUBC/S400-A6 | InGaN    | Super Blue    | Water Clear |

## Technical Data Sheet

## 3.0mm Round Type LED Lamps

A214B/SUBC/S400-A6

## Package Dimensions

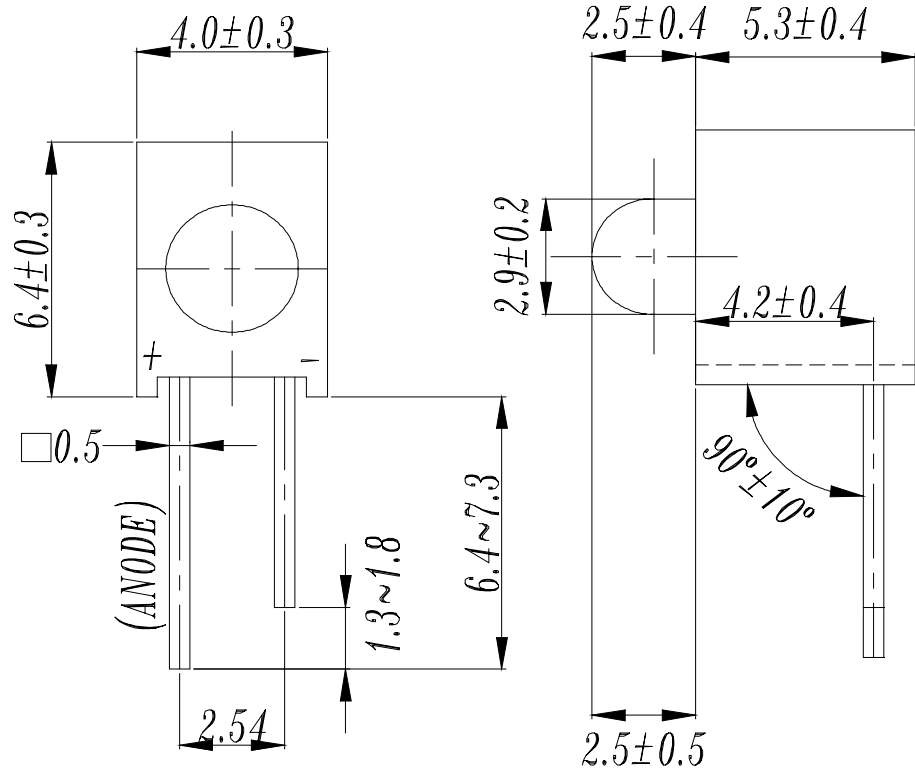

- Notes: 1.All dimensions are in millimeters, tolerance is 0.25mm except being specified  
 2.Lead spacing is measured where the lead emerge from the package  
 The product itself will remain within RoHS compliant version

**Absolute Maximum Ratings at  $T_a = 25^\circ\text{C}$** 

| Parameter               | Symbol    | Rating      | Unit             |
|-------------------------|-----------|-------------|------------------|
| Forward Current         | $I_F$     | 30          | mA               |
| Operating Temperature   | $T_{opr}$ | -40 to +85  | $^\circ\text{C}$ |
| Storage Temperature     | $T_{stg}$ | -40 to +100 | $^\circ\text{C}$ |
| Soldering Temperature   | $T_{sol}$ | $260 \pm 5$ | $^\circ\text{C}$ |
| Electrostatic Discharge | ESD       | 150         | V                |
| Power Dissipation       | $P_d$     | 130         | mW               |
| Reverse Voltage         | $V_R$     | 5           | V                |

Note: \*1:Soldering time  $\leq 5$  seconds.



## Technical Data Sheet

## 3.0mm Round Type LED Lamps

A214B/SUBC/S400-A6

Electro-Optical Characteristics(Ta=25°C)

| Parameter                    | Symbol         | Condition              | Min. | Typ. | Max. | Unit |
|------------------------------|----------------|------------------------|------|------|------|------|
| Forward Voltage              | V <sub>F</sub> | I <sub>F</sub> = 20 mA | /    | 3.4  | 4.0  | V    |
| Reverse Current              | I <sub>R</sub> | V <sub>R</sub> = 5 V   | /    | /    | 50   | μA   |
| Luminous Intensity           | I <sub>v</sub> | I <sub>F</sub> = 20 mA | 500  | 800  | /    | mcd  |
| Viewing Angle                | 2θ 1/2         | I <sub>F</sub> = 20 mA | /    | 30   | /    | deg  |
| Peak Wavelength              | λ <sub>p</sub> | I <sub>F</sub> = 20 mA | /    | 468  | /    | nm   |
| Dominant Wavelength          | λ <sub>d</sub> | I <sub>F</sub> = 20 mA | /    | 470  | /    | nm   |
| Spectrum Radiation Bandwidth | Δλ             | I <sub>F</sub> = 20 mA | /    | 35   | /    | nm   |



Technical Data Sheet

3.0mm Round Type LED Lamps

A214B/SUBC/S400-A6

Typical Electro-Optical Characteristic Curves:

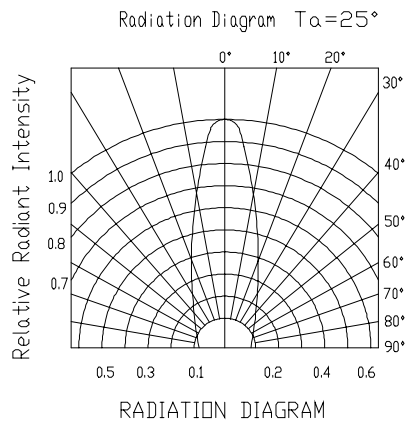
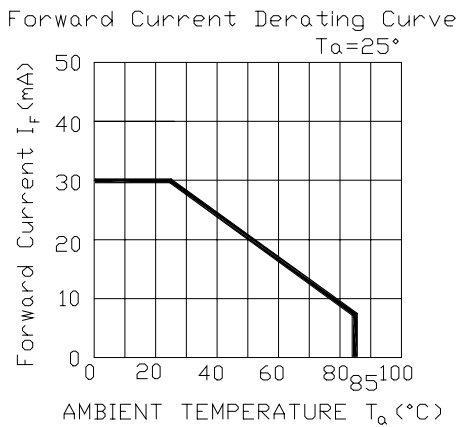
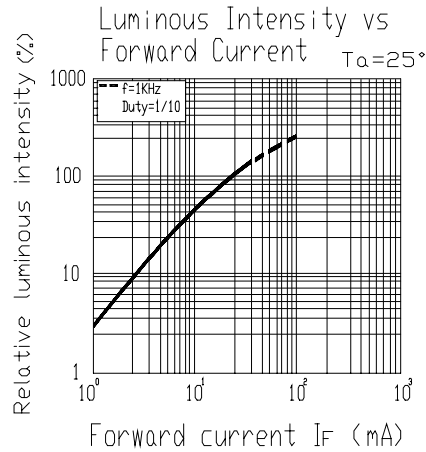
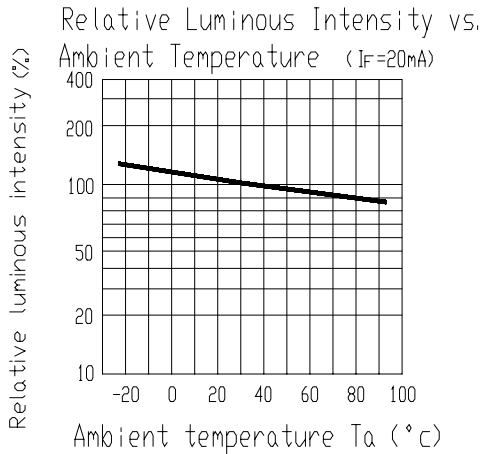
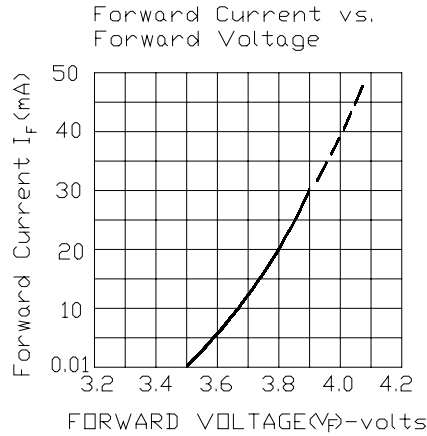
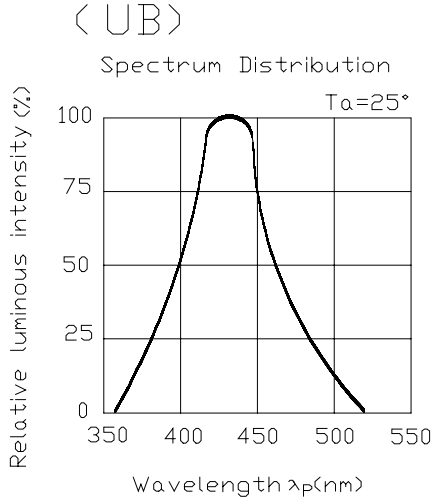



## Technical Data Sheet

## 3.0mm Round Type LED Lamps

A214B/SUBC/S400-A6

■ Reliability test items and conditions:

The reliability of products shall be satisfied with items listed below.

Confidence level : 97%

LTPD : 3%

| NO        | Item                             | Test Conditions                                     | Test Hours/Cycle | Sample Size | Failure Judgment Criteria   | Ac/Re |
|-----------|----------------------------------|---|------------------|-------------|---|-------|
| 1         | Solder Heat                      | TEMP : 260°C ± 5 °C                                 | 10 SEC           | 76 PCS      | $I_v \leq I_{vt} * 0.5$<br>or<br>$V_f \geq U$<br>or<br>$V_f \leq L$ | 0/1   |
| 2         | Temperature Cycle                | H : +100°C 15min<br>$\int$ 5 min<br>L : -40°C 15min | 300 CYCLES       | 76 PCS      |   | 0/1   |
| 3         | Thermal Shock                    | H : +100°C 5min<br>$\int$ 10 sec<br>L : -10°C 5min  | 300 CYCLES       | 76 PCS      |   | 0/1   |
| 4         | High Temperature Storage         | TEMP : 100°C  | 1000 HRS         | 76 PCS      |   | 0/1   |
| 5         | Low Temperature Storage          | TEMP : -40°C  | 1000 HRS         | 76 PCS      |   | 0/1   |
| 6         | DC Operating Life                | TEMP : 25°C<br>$I_F = 20\text{mA}$                  | 1000 HRS         | 76 PCS      |   | 0/1   |
| main with | High Temperature / High Humidity | 85°C / 85% RH                                       | 1000 HRS         | 76 PCS      |   | 0/1   |

Note :  $I_{vt}$  : To test  $I_v$  value of the chip before the reliability test

$I_v$  : The test value of the chip that has completed the reliability test

U : Upper Specification Limit

L : Lower Specification Limit



Technical Data Sheet

3.0mm Round Type LED Lamps

A214B/SUBC/S400-A6

Packing Quantity Specification

1.500PCS/1Bag · 4Bags/1Box

2. 10Boxes/1Carton

Label Form Specification



CPN: Customer' s Production Number

P/N : Production Number

QTY: Packing Quantity

CAT: Ranks

HUE: Dominant Wavelength

REF: Reference

LOT No: Lot Number

MADE IN TAIWAN: Production Place

Notes

1. Above specification may be changed without notice. EVERLIGHT will reserve authority on material change for above specification.

The product itself will remain within RoHS compliant version

for using outlined in these specification sheets. EVERLIGHT assumes no responsibility for any damage resulting from use of the product which does not comply with the absolute

maximum ratings and the instructions included in these specification sheets.

3. These specification sheets include materials protected under copyright of EVERLIGHT corporation.

Please don' t reproduce or cause anyone to reproduce them without EVERLIGHT' s consent.

|  |   |
|--|---|
| <i>EVERLIGHT ELECTRONICS CO., LTD.</i>               | <i>Tel: (886-2-2267-2000, 2267-9936</i>         |
| <i>Office: No 25, Lane 76, Sec 3, Chung Yang Rd,</i> | <i>Fax: 886-2267-6244, 2267-6189, 2267-6306</i> |
| <i>Tucheng, Taipei 236, Taiwan, R.O.C</i>            | <i>http://www.everlight.com</i>                 |