





THIS INFORMATION IS CONFIDENTIAL AND PROPRIETARY TO CW INDUSTRIES INCORPORATED AND ITS AFFILIATES. IT MAY NOT BE DISCLOSED TO ANYONE, OTHER THAN CW INDUSTRIES PERSONNEL, WITHOUT WRITTEN AUTHORIZATION FROM CW INDUSTRIES INCORPORATED, SOUTHAMPTON, PENNSYLVANIA USA.

Rating	8A 125V AC, 4A 250V AC	 	Mounting Hole		 <b>SPST (ON) - OFF</b> ( ) = Momentary											
	10A 125V AC, 6A 250V AC															
	10A 28V DC, 6A 14 VT															
Contact Resistance	50m ohm max.	<table border="1"> <thead> <tr> <th>Thickness</th> <th>X</th> <th>Y</th> </tr> </thead> <tbody> <tr> <td>0.75 - 1.25</td> <td>19.2 - 0.1</td> <td>7.0 + 0.1</td> </tr> <tr> <td>1.25 - 2.00</td> <td>19.4 - 0.1</td> <td>7.0 + 0.1</td> </tr> <tr> <td>2.00 - 3.00</td> <td>19.8 - 0.1</td> <td>7.0 + 0.1</td> </tr> </tbody> </table>		Thickness	X	Y	0.75 - 1.25	19.2 - 0.1	7.0 + 0.1	1.25 - 2.00	19.4 - 0.1	7.0 + 0.1	2.00 - 3.00	19.8 - 0.1	7.0 + 0.1	
Thickness	X	Y														
0.75 - 1.25	19.2 - 0.1	7.0 + 0.1														
1.25 - 2.00	19.4 - 0.1	7.0 + 0.1														
2.00 - 3.00	19.8 - 0.1	7.0 + 0.1														
Insulation Resistance	DC 500V 100M ohm min.															
Dielectric Strength	AC 1500V 1 minute															
Operating Temperature	-25° C ~ 85° C															

**BASE COLOR: Black**  
**BUTTON COLOR: Black**

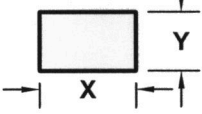
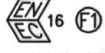
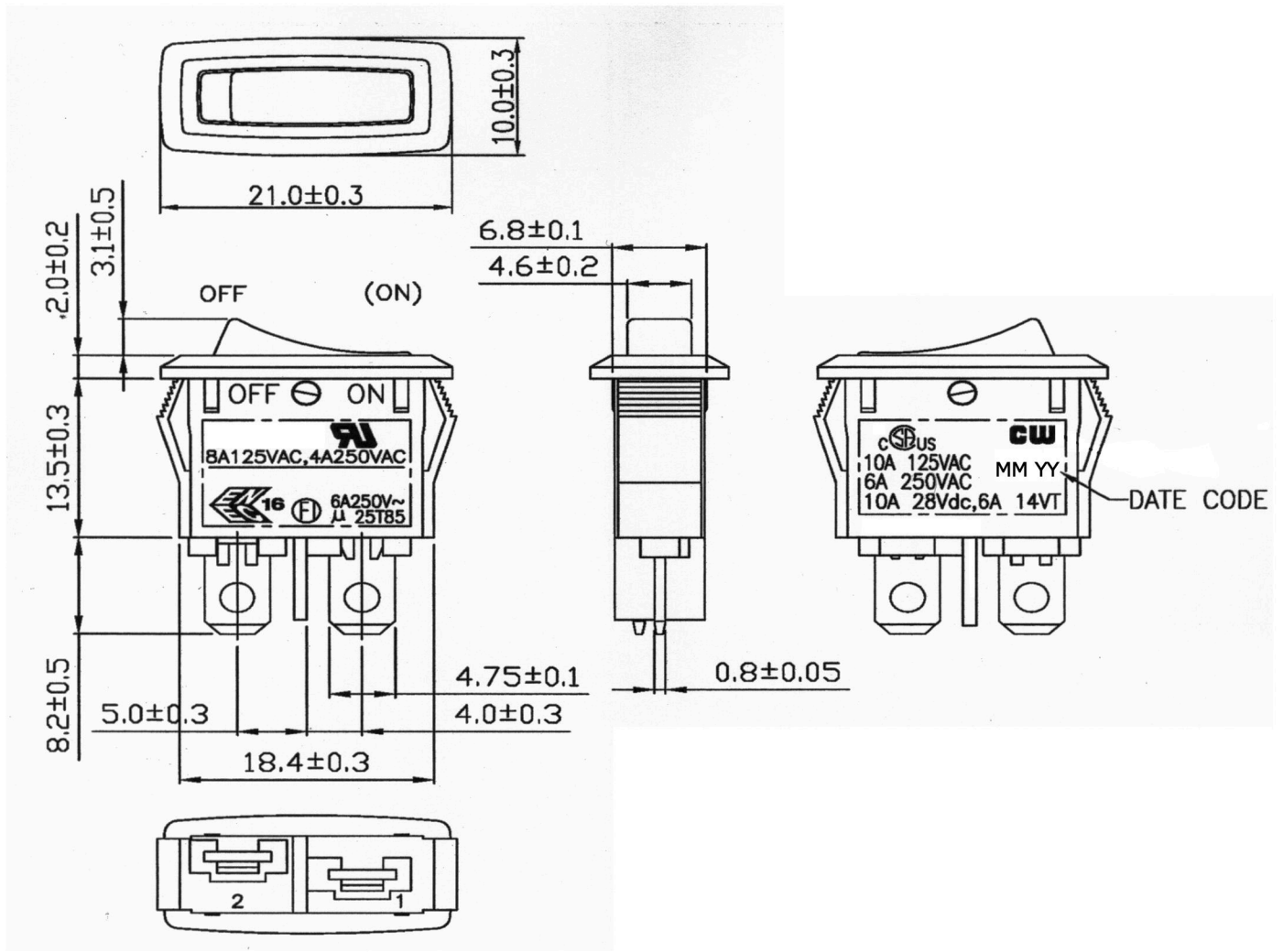

RoHS Compliant

 <b>CW INDUSTRIES</b> Southampton, Pa. 18966 Tel 215.355.7080/www.cwind.com	Date Drawn: 12/21/09	Rev. 0	Unit: mm	Checked By: G. Guld
	Title: <b>ROCKER SWITCH</b>		CW P/N: <b>GRB243F02BB</b>	