

PLEASE CHECK WWW.MOLEX.COM FOR LATEST PART INFORMATION

Part Number: **0876331004**

Status: **Active**

Overview: extreme_powerplus_ssi

Description: 6.35mm (.250") Pitch, Power, 2.54mm (.100") Pitch, Signal, EXTreme PowerPlus™ P-S-P Receptacle, Press-fit, Vertical, 30 Circuits, Power Beta 2, Signal 24, Power Alpha 4, No Recessed Power Circuit, without Beveled Metal Pins, Leadfree

Documents:

[3D Model](#)

[Drawing \(PDF\)](#)

[Product Specification PS-87633-006 \(PDF\)](#)

[RoHS Certificate of Compliance \(PDF\)](#)

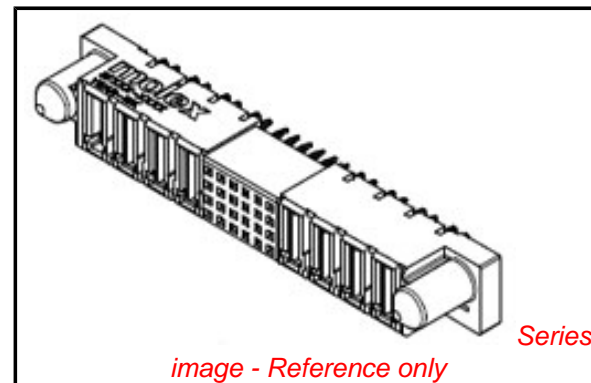

General

Product Family	PCB Receptacles
Series	87633
Application	Board-to-Board
Comments	No Recessed Power Circuits
Overview	<u>extreme_powerplus_ssi</u>
Product Literature Order No	987650-3002
Product Name	EXTreme PowerPlus™

Physical

Circuits (Loaded)	30
Circuits Detail	Power Beta 2, Signal 24, Power Alpha 4
Color - Resin	Black
Durability (mating cycles max)	100
Glow-Wire Compliant	No
Guide to Mating Part	Yes
Keying to Mating Part	Yes
Material - Metal	Copper Alloy
Material - Plating Mating	Gold
Material - Plating Termination	Tin
Material - Resin	High Temperature Thermoplastic
Number of Rows	4
Orientation	Vertical
PC Tail Length (in)	0.135 In
PC Tail Length (mm)	3.43 mm
PCB Locator	No
PCB Retention	None
PCB Thickness Recommended (in)	0.093 In
PCB Thickness Recommended (mm)	2.40 mm
Packaging Type	Tray
Pitch - Mating Interface (in)	0.100 In, 0.250 In
Pitch - Mating Interface (mm)	2.54 mm, 6.35 mm
Plating min: Mating (µin)	30
Plating min: Mating (µm)	0.76
Plating min: Termination (µin)	100
Plating min: Termination (µm)	2.54
Polarized to Mating Part	Yes
Polarized to PCB	Yes
Temperature Range - Operating	-20°C to +105°C
Termination Interface: Style	Through Hole - Compliant Pin

Electrical

Current - Maximum per Contact	2.5A, 30A
Voltage - Maximum	50V DC

EU RoHS

ELV and RoHS Compliant

REACH SVHC

Not Reviewed

Halogen-Free

Status

Not Reviewed

China RoHS



Need more information on product environmental compliance?

Email productcompliance@molex.com
For a multiple part number RoHS Certificate of Compliance, [click here](#)

Please visit the [Contact Us](#) section for any non-product compliance questions.

Search Parts in this Series

87633Series

Mates With

87631 EXTreme PowerPlus™ P-S-P Header

Material Info

Reference - Drawing Numbers

Application Specification
Product Specification
Sales Drawing

AS-87631-018, AS-87633-007
PS-87633-006
SD-87633-013

This document was generated on 05/21/2010

PLEASE CHECK WWW.MOLEX.COM FOR LATEST PART INFORMATION

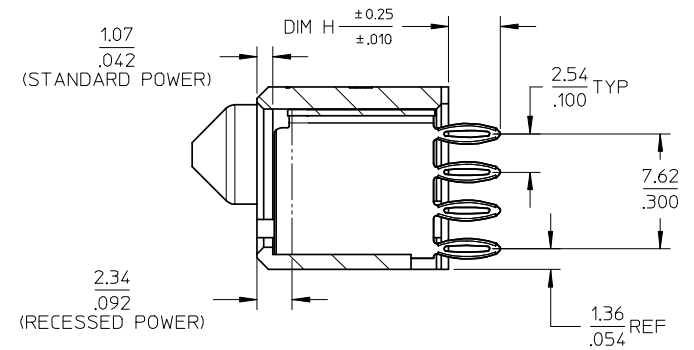
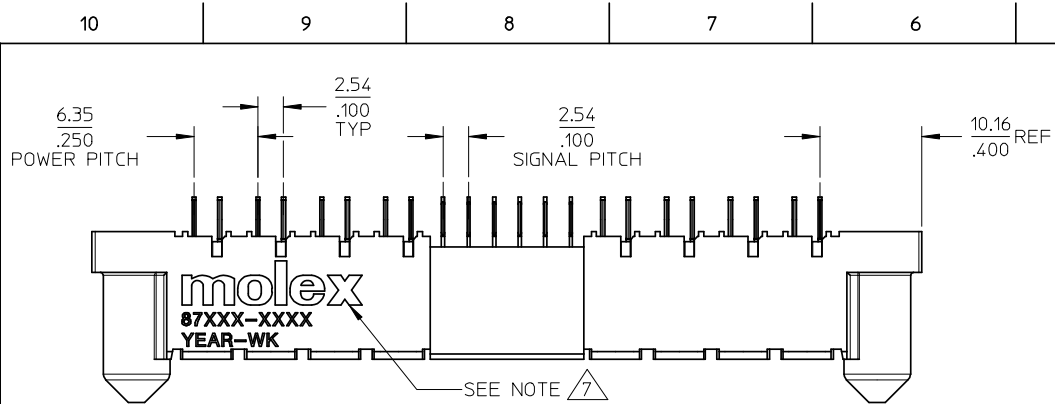

SECTION A-A

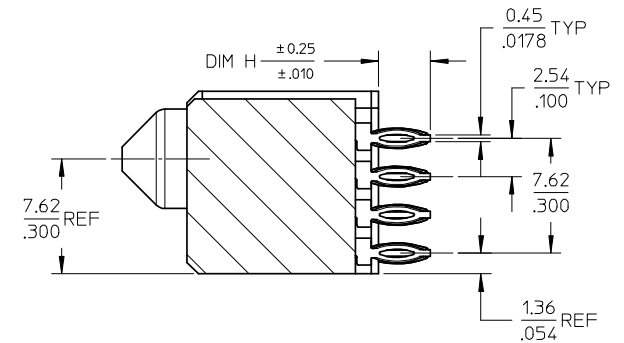
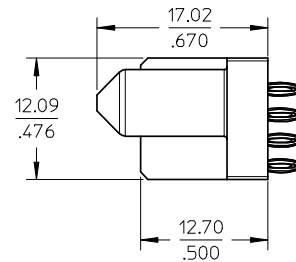
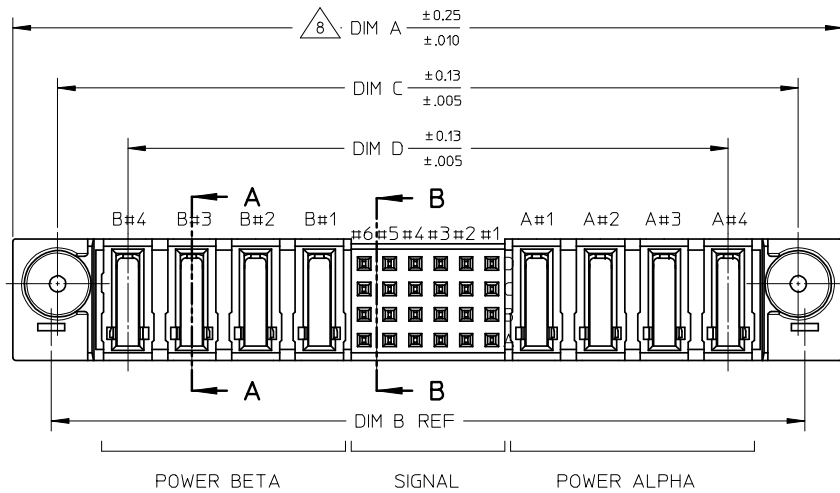

SECTION B-B

PDR#S00-1777-00-00 EC NO: S2008-0921 DRWN:SKANG 2008/04/15 CHKD:ATSEE 2008/04/15 APPR:MLONG 2008/04/15	DESCRIPTION C7	QUALITY SYMBOLS ▽=0 ◻=0	GENERAL TOLERANCES (UNLESS SPECIFIED)		DIMENSION STYLE MM/IN		SCALE NTS	DESIGN UNITS METRIC	THIRD ANGLE PROJECTION																												
			<table border="1"> <thead> <tr> <th></th> <th>mm</th> <th>INCH</th> </tr> </thead> <tbody> <tr> <td>4 PLACES</td> <td>± ---</td> <td>± ---</td> </tr> <tr> <td>3 PLACES</td> <td>± ---</td> <td>± .010</td> </tr> <tr> <td>2 PLACES</td> <td>± 0.25</td> <td>± ---</td> </tr> <tr> <td>1 PLACE</td> <td>± ---</td> <td>± ---</td> </tr> </tbody> </table>		mm	INCH	4 PLACES	± ---	± ---	3 PLACES	± ---	± .010	2 PLACES	± 0.25	± ---	1 PLACE	± ---	± ---	<table border="1"> <thead> <tr> <th>DRAWN BY</th> <th>DATE</th> <th>TITLE</th> </tr> </thead> <tbody> <tr> <td>KMGOH</td> <td>2002/11/19</td> <td rowspan="4"> POWER CONN. RECEPTACLE P-S-P CONFIGURATION VERT. PRESS-FIT,W/G POST MOLEX INCORPORATED </td> </tr> <tr> <td>CHECKED BY</td> <td>DATE</td> </tr> <tr> <td>APPROVED BY</td> <td>DATE</td> </tr> <tr> <td>SKTOH</td> <td>2002/11/21</td> </tr> </tbody> </table>	DRAWN BY	DATE	TITLE	KMGOH	2002/11/19	POWER CONN. RECEPTACLE P-S-P CONFIGURATION VERT. PRESS-FIT,W/G POST MOLEX INCORPORATED	CHECKED BY	DATE	APPROVED BY	DATE	SKTOH	2002/11/21	MATERIAL NO. SEE TABLE		DOCUMENT NO. SD-87633-013		SHEET NO. 1 OF 4	
			mm	INCH																																	
		4 PLACES	± ---	± ---																																	
3 PLACES	± ---	± .010																																			
2 PLACES	± 0.25	± ---																																			
1 PLACE	± ---	± ---																																			
DRAWN BY	DATE	TITLE																																			
KMGOH	2002/11/19	POWER CONN. RECEPTACLE P-S-P CONFIGURATION VERT. PRESS-FIT,W/G POST MOLEX INCORPORATED																																			
CHECKED BY	DATE																																				
APPROVED BY	DATE																																				
SKTOH	2002/11/21																																				
DRAFT WHERE APPLICABLE MUST REMAIN WITHIN DIMENSIONS			SIZE A3		THIS DRAWING CONTAINS INFORMATION THAT IS PROPRIETARY TO MOLEX INCORPORATED AND SHOULD NOT BE USED WITHOUT WRITTEN PERMISSION																																

- NOTES
- MATERIALS :-
HOUSING - LCP, GLASS FILLED, UL94V-0,
COLOR: BLACK.
SIGNAL TERMINAL - COPPER ALLOY
POWER TERMINAL - COPPER ALLOY
 - FINISH :-
SIGNAL & POWER CONTACTS
0.76 MICROMETER MINIMUM GOLD (Au) AT CONTACT AREA
AND 2.54 MICROMETER MINIMUM TIN/LEAD OR TIN AT SOLDER TAIL
AREA OVER 1.27um MINIMUM NICKEL (Ni) UNDERPLATE.
 - SPECIFICATIONS :-
PRODUCT SPECIFICATION : PS-87633-006
APPLICATION SPECIFICATION : AS-87633-007
 - COMPONENT STAY AWAY ZONE FROM CONNECTOR.
 - PCB NOTE FOR DIAMETER 1.02/.040 PLATED HOLE.
- DRILLED HOLE SIZE IS 1.151/.0453
- PLATED WITH 0.007/.0003 MINIMUM TIN/LEAD OR TIN OVER
0.03/.001 TO 0.08/.003 COPPER PLATING TO ACHIEVE
1.02±0.08/.040±.003 HOLE.
 - ALL TERMINAL TIPS ARE DESIGNED WITH EXPOSED BASE COPPER.
THIS IS CREATED BY FINAL CUTTING PROCESS AFTER PLATING.
 - MANUFACTURER LOGO, PART NUMBER AND YEAR-WEEK CODE.
 - 4Pa-24S-4Pb CONFIGURATION IS SHOWN FOR ILLUSTRATION ONLY.
P-S-P CONFIGURATION IS AVAILABLE UP TO 203MM/8INCH.
PLEASE CONTACT MOLEX SALES PERSONNEL FOR OTHER
CONFIGURATION AND OPTION NEEDED.
 - IMAGINARY LINE AND DIMENSION TO POSITION AND PROVIDE
CONNECTOR ORIENTATION WITH RESPECT TO PCB LAYOUT.
 - OPTIONAL BOARDLOCK FEATURE FOR SYMETRICAL POWER CONFIG
FULL PROOFING UPON CUSTOMER REQUEST.

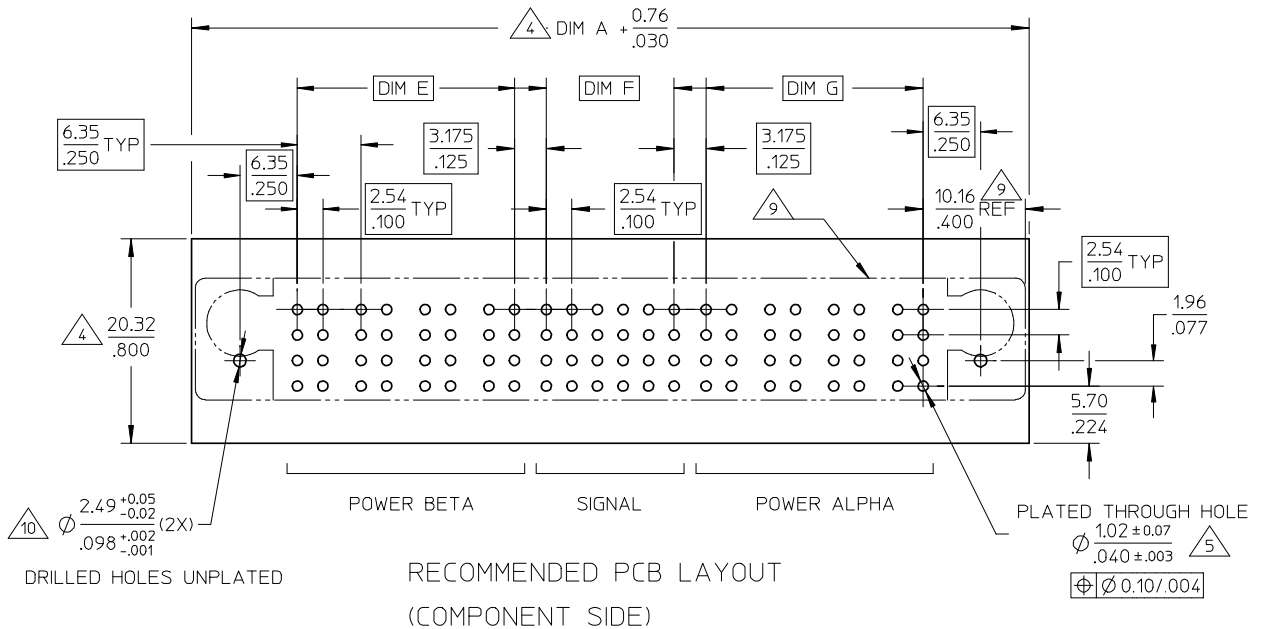

PDR# S00-1777-00-00 EC NO: S2008-0921 DRWN: SKANG 2008/04/15 CHKD: ATSEE 2008/04/15 APPR: WLONG 2008/04/15	QUALITY SYMBOLS ▽=0 ▽=0	GENERAL TOLERANCES (UNLESS SPECIFIED)		DIMENSION STYLE MM/IN		SCALE NTS	DESIGN UNITS METRIC	THIRD ANGLE PROJECTION		
			mm	INCH	DRAWN BY KMG0H	DATE 2002/11/19	TITLE POWER CONN. RECEPTACLE P-S-P CONFIGURATION VERT. PRESS-FIT, W/G POST			
		4 PLACES ± --- ± --- 3 PLACES ± --- ± .010 2 PLACES ± 0.25 ± --- 1 PLACE ± --- ± ---			CHECKED BY PTL IM	DATE 2002/11/21	MOLEX INCORPORATED			
		ANGULAR ± 3 °			APPROVED BY SKTOH	DATE 2002/11/21	MATERIAL NO. SEE TABLE	DOCUMENT NO. SD-87633-013	SHEET NO. 2 OF 4	
DRAFT WHERE APPLICABLE MUST REMAIN WITHIN DIMENSIONS			THIS DRAWING CONTAINS INFORMATION THAT IS PROPRIETARY TO MOLEX INCORPORATED AND SHOULD NOT BE USED WITHOUT WRITTEN PERMISSION							

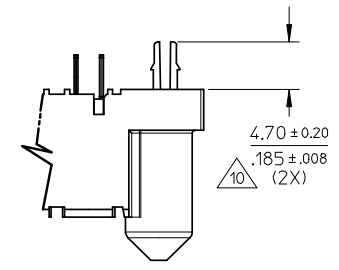

PART NUMBER	P-S-P CONFIGURATION			RECESSED POWER CIRCUIT#	DIMENSIONS								BOARDLOCK OPTION 	PACKAGING	PLATING OPTION	
	POWER BETA	SIGNAL	POWER ALPHA		A	B	C	D	E	F	G	H				
87633-8000	5	24	3	NIL	82.54 3.250	74.93 2.950	73.65 2.900	59.69 2.350	27.94 1.100	12.70 .500	15.24 .600	3.43 .135	NIL	TRAY	TIN/LEAD	
87633-8002	4	24	4	NIL	82.54 3.250	74.93 2.950	73.65 2.900	59.69 2.350	21.59 .850	12.70 .500	21.59 .850	3.43 .135				
87633-8003	3	24	3	NIL	69.84 2.750	62.23 2.450	60.95 2.400	46.99 1.850	15.24 .600	12.70 .500	15.24 .600	3.43 .135				
87633-8004	2	24	4	NIL	69.84 2.750	62.23 2.450	60.95 2.400	46.99 1.850	8.89 .350	12.70 .500	21.59 .850	3.43 .135				
87633-8005	2	48	2	A2, B2	72.38 2.850	64.77 2.550	63.49 2.500	49.53 1.950	8.89 .350	27.94 1.100	8.89 .350	3.43 .135				YES
87633-8011	7	32	6	NIL	119.38 4.700	111.76 4.400	110.48 4.350	96.52 3.800	40.64 1.600	17.78 .700	34.29 1.350	3.43 .135				NIL
87633-8013	1	12	1	NIL	36.83 1.450	29.21 1.150	27.94 1.100	13.97 .550	2.54 .100	5.08 .200	2.54 .100	3.43 .135				NIL
87633-8021	6	32	7	A1,A2,A3,A4 B1,B2,B5,B6	119.38 4.700	111.76 4.400	110.48 4.350	96.52 3.800	34.29 1.350	17.78 .700	40.64 1.600	3.43 .135				YES
87633-8022	4	4	4	NIL	69.85 2.750	62.23 2.450	60.96 2.400	46.99 1.850	21.59 .850	00.00 0.000	21.59 .850	3.43 .135				YES
87633-8014	2	16	4	A3,A4,B2	64.77 2.550	57.15 2.250	55.88 2.200	41.91 1.650	8.89 .350	7.62 .300	21.59 .850	3.43 .135				NIL

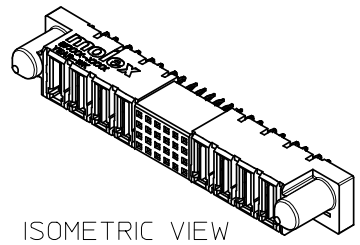

BOARDLOCK OPTION





ISOMETRIC VIEW

PDR#S00-1777-00-00 EC NO: S2008-0921 DRWN:SKANG 2008/04/15 CH'KD:ATSEE 2008/04/15 APPR:MLONG 2008/04/15	QUALITY SYMBOLS  = 0  = 0	GENERAL TOLERANCES (UNLESS SPECIFIED)		DIMENSION STYLE MM/IN		SCALE NTS	DESIGN UNITS METRIC	 THIRD ANGLE PROJECTION	
		4 PLACES ± --- ± --- 3 PLACES ± --- ± .010 2 PLACES ± 0.25 ± --- 1 PLACE ± --- ± ---	mm INCH ± --- ± --- ± 0.25 ± --- ± --- ± ---	DRAWN BY KMG0H	DATE 2002/11/19	TITLE POWER CONN. RECEPTACLE P-S-P CONFIGURATION VERT. PRESS-FIT,W/G POST			
		ANGULAR ± 3 °		CHECKED BY PTLIM	DATE 2002/11/21	MOLEX INCORPORATED			
		DRAFT WHERE APPLICABLE MUST REMAIN WITHIN DIMENSIONS		APPROVED BY SKTOH	DATE 2002/11/21	MATERIAL NO. SEE TABLE	DOCUMENT NO. SD-87633-013	SHEET NO. 3 OF 4	

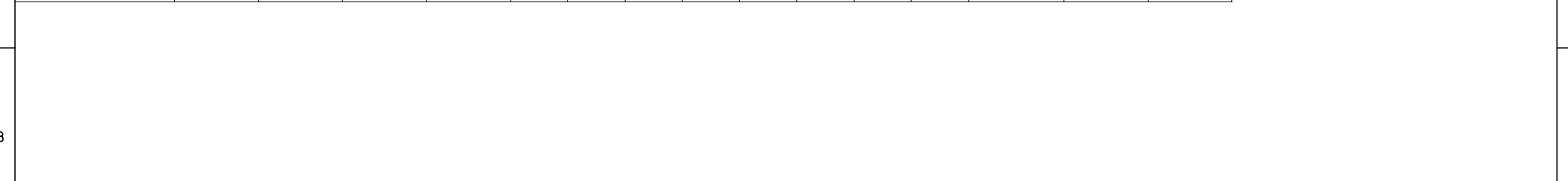
PART NUMBER	P-S-P CONFIGURATION			RECESSED POWER CIRCUIT#	DIMENSIONS								BOARDLOCK OPTION 	PACKAGING	PLATING OPTION	
	POWER BETA	SIGNAL	POWER ALPHA		A	B	C	D	E	F	G	H				
87633-1000	5	24	3	NIL	82.54 3.250	74.93 2.950	73.65 2.900	59.69 2.350	27.94 1.100	12.70 .500	15.24 .600	3.43 .135	NIL	TRAY	TIN	
87633-1002	4	24	4	NIL	82.54 3.250	74.93 2.950	73.65 2.900	59.69 2.350	21.59 .850	12.70 .500	21.59 .850	3.43 .135				
87633-1003	3	24	3	NIL	69.84 2.750	62.23 2.450	60.95 2.400	46.99 1.850	15.24 .600	12.70 .500	15.24 .600	3.43 .135				
87633-1004	2	24	4	NIL	69.84 2.750	62.23 2.450	60.95 2.400	46.99 1.850	8.89 .350	12.70 .500	21.59 .850	3.43 .135				
87633-1005	2	48	2	A2, B2	72.38 2.850	64.77 2.550	63.49 2.500	49.53 1.950	8.89 .350	27.94 1.100	8.89 .350	3.43 .135				YES
87633-1011	7	32	6	NIL	119.38 4.700	111.76 4.400	110.48 4.350	96.52 3.800	40.64 1.600	17.78 .700	34.29 1.350	3.43 .135				NIL
87633-1013	1	12	1	NIL	36.83 1.450	29.21 1.150	27.94 1.100	13.97 .550	2.54 .100	5.08 .200	2.54 .100	3.43 .135				
87633-1021	6	32	7	A1,A2,A3,A4 B1,B2,B5,B6	119.38 4.700	111.76 4.400	110.48 4.350	96.52 3.800	34.29 1.350	17.78 .700	40.64 1.600	3.43 .135				
87633-1022	4	4	4	NIL	69.85 2.750	62.23 2.450	60.96 2.400	46.99 1.850	21.59 .850	00.00 0.000	21.59 .850	3.43 .135				YES
87633-1014	2	16	4	A3,A4,B2	64.77 2.550	57.15 2.250	55.88 2.200	41.91 1.650	8.89 .350	7.62 .300	21.59 .850	3.43 .135				NIL
87633-1024	2	24	2	A2, B2	57.15 2.250	49.53 1.950	48.26 1.900	34.29 1.350	8.89 .350	12.70 .5000	8.89 .350	3.43 .135	YES			
87633-1028													NIL			
87633-1026	4	48	4	NIL	97.79 3.850	90.17 3.550	88.90 3.500	74.93 2.950	21.59 0.850	27.94 1.100	21.59 0.850	3.43 .135	YES			
87633-1029	2	16	4	NIL	64.77 2.550	57.15 2.250	55.88 2.200	41.91 1.650	8.89 .350	7.62 .300	21.59 .850	3.43 .135	NIL			



PDR#S00-1777-00-00 EC NO: S2008-0921 DRWN:SKANG 2008/04/15 CHKD:ATSEE 2008/04/15 APPR:MLONG 2008/04/15 C7	QUALITY SYMBOLS  = 0  = 0	DESCRIPTION REV	GENERAL TOLERANCES (UNLESS SPECIFIED)		DIMENSION STYLE MM/IN		SCALE NTS	DESIGN UNITS METRIC	 THIRD ANGLE PROJECTION	
			4 PLACES ± --- ± ---	3 PLACES ± --- ± .010	DRAWN BY KMG0H	DATE 2002/11/19	TITLE POWER CONN. RECEPTACLE P-S-P CONFIGURATION VERT. PRESS-FIT,W/G POST			
			2 PLACES ± 0.25 ± ---	1 PLACE ± --- ± ---	CHECKED BY PTL IM	DATE 2002/11/21	MOLEX INCORPORATED			
			ANGULAR ± 3 °		APPROVED BY SKTOH	DATE 2002/11/21	MATERIAL NO. SEE TABLE	DOCUMENT NO. SD-87633-013	SHEET NO. 4 OF 4	
DRAFT WHERE APPLICABLE MUST REMAIN WITHIN DIMENSIONS			THIS DRAWING CONTAINS INFORMATION THAT IS PROPRIETARY TO MOLEX INCORPORATED AND SHOULD NOT BE USED WITHOUT WRITTEN PERMISSION							