

PLEASE CHECK WWW.MOLEX.COM FOR LATEST PART INFORMATION

Part Number: [0009070048](#)
Status: **Active**
Overview: [kk](#)
Description: 3.96mm (.156") KK® IDT Double Cantilever Contact, 4 Circuits, Tin (Sn), Feed-To, 18 Solid or Fused Stranded, Yellow ID Strip

Documents:

[3D Model](#) [Product Specification PS-7660 \(PDF\)](#)
[Drawing \(PDF\)](#) [RoHS Certificate of Compliance \(PDF\)](#)

Agency Certification

UL E29179

General

Product Family IDT and Solder Connectors
 Series [7675](#)
 Comments Double Cantilever contact
 Crimp Quality Equipment Yes
 Overview [kk](#)
 Product Name KK®

Physical

Circuits (Loaded) 4
 Color - Resin Natural
 Flammability 94V-2
 Gender Female
 Glow-Wire Compliant No
 Lock to Mating Part None
 Material - Metal Brass
 Material - Plating Mating Tin
 Material - Plating Termination Tin
 Material - Resin Nylon
 Number of Rows 1
 Packaging Type Bag
 Panel Mount No
 Pitch - Mating Interface (in) 0.156 In
 Pitch - Mating Interface (mm) 3.96 mm
 Plating min: Mating (µin) 200
 Plating min: Mating (µm) 5
 Plating min: Termination (µin) 200
 Plating min: Termination (µm) 5
 Temperature Range - Operating 0°C to +75°C
 Termination Interface: Style IDT or Pierce
 Wire Size AWG 18 Solid, 18 Stranded Topcoat

Electrical

Voltage - Maximum 250V

Material Info

Old Part Number A-7675-C04A

Reference - Drawing Numbers

Packaging Specification PK-7674-001
 Product Specification PS-7660
 Sales Drawing SDA-7675-****

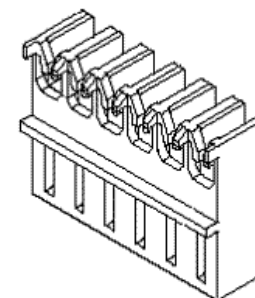

*Series
image - Reference only*

EU RoHS

**ELV and RoHS
Compliant**
**REACH SVHC
Contains SVHC: No
Halogen-Free
Status
Not Reviewed**

China RoHS



**Need more information on product
environmental compliance?**

Email productcompliance@molex.com
 For a multiple part number RoHS Certificate of Compliance, [click here](#)

Please visit the [Contact Us](#) section for any non-product compliance questions.

Search Parts in this Series

[7675Series](#)

Application Tooling | [FAQ](#)

Tooling specifications and manuals are found by selecting the products below. Crimp Height Specifications are then contained in the Application Tooling Specification document.

Global

Description	Product #
Insertion Tool for 3.96mm (.156") Pitch KK® IDT Crimp Terminals	0638133503
IDT - Manual Press For Ribbon Cable	0011200314
IDT - Semi-automatic - Bench-Top Terminator	0011200418
IDT - Manual Handtool	0011215196
IDT Manual Handtool Arbor Press Fixture	0621000400 0690200770

This document was generated on 05/27/2010

PLEASE CHECK WWW.MOLEX.COM FOR LATEST PART INFORMATION

NOTES:

1. MATERIAL: HOUSING - NYLON 6/6, UL94V-2, COLOR: NATURAL
TERMINALS - BRASS, (0.28)/.011 THICK
2. FINISH: SEE SHEET 2
3. PRODUCT SPECIFICATION: PS-7660
4. PACKAGING: ALL PARTS ARE TO BE BULK PACKED PER PK-7674-001 UNLESS OTHERWISE SPECIFIED IN CHART.
5. CHAIN CUTOFF: "A" DIMENSION PLUS (0.25)/.010.
6. EACH CIRCUIT MUST HAVE A MINIMUM OF 0.50 POUNDS RETENTION WHEN CHECKED WITH A TIN PLATED [(102) PLT.] (1.14)/.045 SQUARE BRASS PIN, AND A TIN PLATED [(102) PLT.] TERMINAL ONLY.
7. THIS PART CONFORMS TO CLASS B REQUIREMENTS OF COSMETIC SPECIFICATION PS-45499-002.

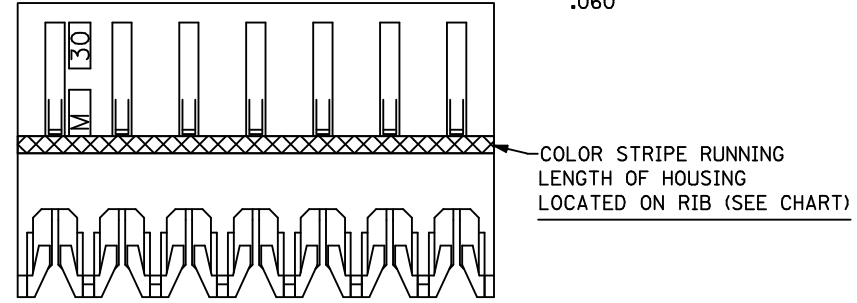
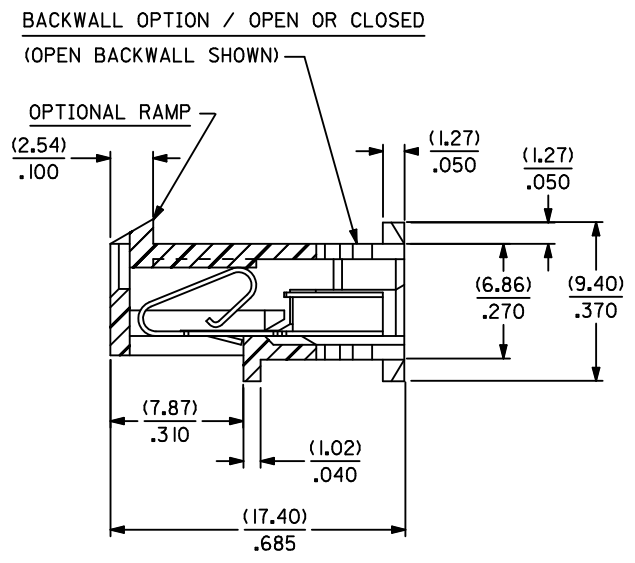
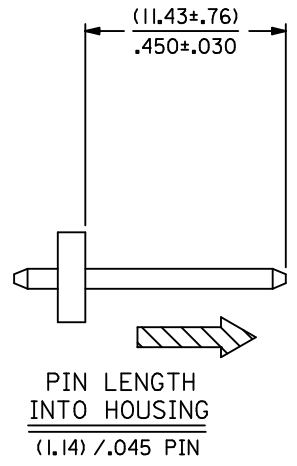
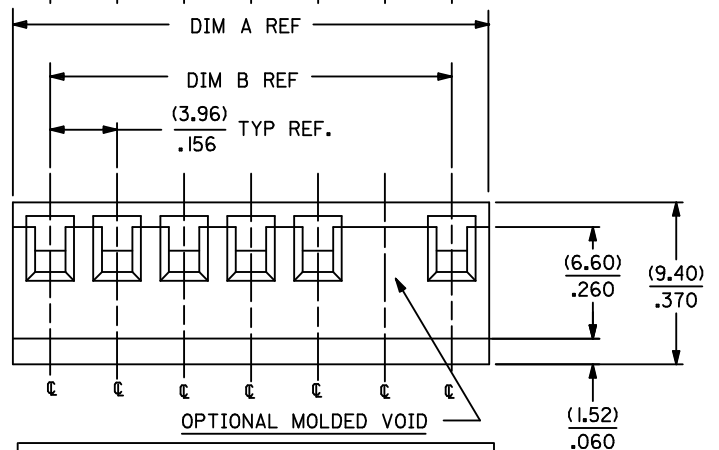
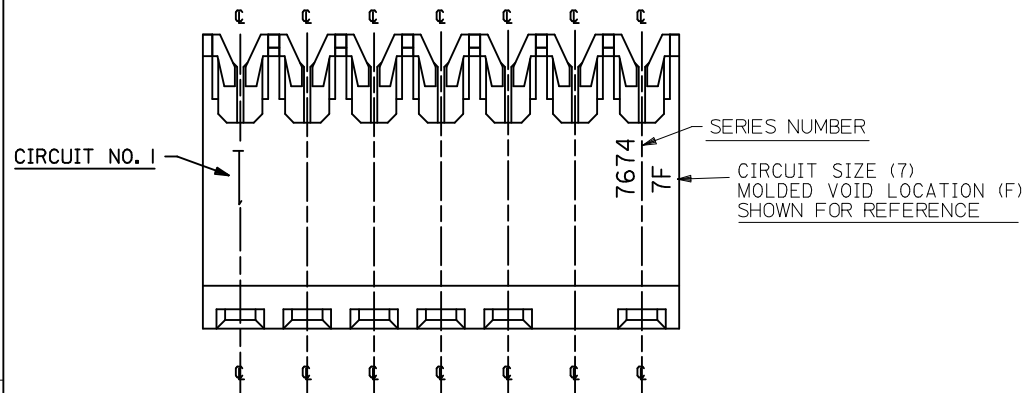

ADD P/N 50-36-1618
 EC NO: UCP2010-0214
 DRWN:MKIPPER 2009/11/05
 CHKD:SSOUSEK 2009/12/16
 APPR:FSM:TH 2009/12/17

QUALITY SYMBOLS	DESCRIPTION
▼=0	
∇=0	

GENERAL TOLERANCES (UNLESS SPECIFIED)		
	mm	INCH
4 PLACES	± ---	± ---
3 PLACES	± ---	± .015
2 PLACES	± 0.36	± .010
1 PLACE	± 0.25	± ---
ANGULAR ±1/2°		
DRAFT WHERE APPLICABLE MUST REMAIN WITHIN DIMENSIONS		

DIMENSION STYLE	
MM/IN	
DRAWN BY	DATE
CHECKED BY	DATE
APPROVED BY	DATE
WRL	1986/02/14
MATERIAL NO.	
SEE CHART	



SCALE ---	DESIGN UNITS INCH	THIRD ANGLE PROJECTION
TITLE		
CONNECTOR ASSEMBLY KK (3.96)/.156 CENTER INSULATION DISPLACEMENT		
MOLEX INCORPORATED		
MATERIAL NO.	DOCUMENT NO.	SHEET NO.
SEE CHART	SDA-7675-****	1 OF *
THIS DRAWING CONTAINS INFORMATION THAT IS PROPRIETARY TO MOLEX INCORPORATED AND SHOULD NOT BE USED WITHOUT WRITTEN PERMISSION		

CIRCUIT SIZE	DIM. "A"	DIM. "B"	CIRCUIT SIZE	DIM. "A"	DIM. "B"
2	(8.38) .330	(3.96) .156	13	(51.97) 2.046	(47.55) 1.872
3	(12.34) .486	(7.92) .312	14	(55.93) 2.202	(51.51) 2.028
4	(16.31) .642	(11.89) .468	15	(59.89) 2.358	(55.47) 2.184
5	(20.27) .798	(15.85) .624	16	(63.86) 2.514	(59.44) 2.340
6	(24.23) .954	(19.81) .780	17	(67.82) 2.670	(63.40) 2.496
7	(28.19) 1.110	(23.77) .936	18	(71.78) 2.826	(67.36) 2.652
8	(32.16) 1.266	(27.74) 1.092	19	(75.74) 2.982	(71.32) 2.808
9	(36.12) 1.422	(31.70) 1.248	20	(79.71) 3.138	(75.29) 2.964
10	(40.08) 1.578	(35.66) 1.404	21	(83.67) 3.294	(79.25) 3.120
11	(44.04) 1.734	(39.62) 1.560	22	(87.63) 3.450	(83.21) 3.276
12	(48.00) 1.890	(43.59) 1.716	23	(91.59) 3.606	(87.17) 3.432
			24	(95.55) 3.762	(91.14) 3.588

COLOR IDENTIFICATION		TYPE OF WIRE TERMINATED (ALL WIRES HAVE A MAXIMUM INSULATION DIAMETER OF (2.41) / .095)
ASSEMBLY SUFFIX NO.	COLOR	
-*NA*	YELLOW	*18 GA. SOLID OR FUSED STRANDED
-*NM*	RED	*20 GA. SOLID OR FUSED STRANDED & *18 GA. STRANDED
-*NL*	BLUE	*20 GA. STRANDED WIRE
-*ND*	GREEN	*26 & *27 GA. STRANDED, FUSED STRANDED & SOLID WIRE OR *24 GA. STRANDED WIRE
-*NJ*	BLACK	*24 & *22 GA. SOLID OR FUSED

TERMINAL FINISH:

- (102) OVERALL BRIGHT TIN: 0.00508/.000200 MIN. OVER COPPER: 0.00254/.000100 MIN.
- (154) OVERALL BRIGHT TIN: 0.00254/.000100 MIN. OVER NICKEL: 0.00127/.000050 MIN.
- (224) OVERALL MATTE TIN: 0.00508/.000200 MIN. OVER NICKEL: 0.00127/.000050 MIN.
- (208) SELECT GOLD: 0.00038/.000015 MIN. SELECT MATTE TIN: 0.00254/.000100 MIN. WITH OVERALL NICKEL UNDERPLATE: 0.00127/.000050 MIN.
- (502) OVERALL GOLD: 0.00051/.000020 MIN. WITH OVERALL NICKEL UNDERPLATE: 0.00127/.000050 MIN.
- (503) OVERALL GOLD: 0.00076/.000030 MIN. WITH OVERALL NICKEL UNDERPLATE: 0.00127/.000050 MIN.
- (555) SELECT GOLD: 0.00038/.000015 MIN. WITH OVERALL NICKEL UNDERPLATE: 0.00076/.000030 MIN.
- (562) SELECT GOLD: 0.00051/.000020 MIN. WITH OVERALL NICKEL UNDERPLATE: 0.00076/.000030 MIN.
- (565) SELECT GOLD: 0.00051/.000020 MIN. OVERALL GOLD FLASH: 0.00005/.000002 MIN. WITH OVERALL NICKEL UNDERPLATE: 0.00076/.000030 MIN.

ADD 224 FINISH EC NO: UCP2010-0214 DRWN:MKIPPER 2009/11/05 CHKD:SSOUSEK 2009/12/16 APPR:FSM:TH 2009/12/17 DESCRIPTION	QUALITY SYMBOLS	GENERAL TOLERANCES (UNLESS SPECIFIED)		DIMENSION STYLE MM/IN		SCALE ---	DESIGN UNITS INCH	THIRD ANGLE PROJECTION	
	 =0  =0	mm	INCH	DRAWN BY	DATE	TITLE CONNECTOR ASSEMBLY KK (3.96)/.156 CENTER INSULATION DISPLACEMENT			
		4 PLACES ± ---	± ---	CHECKED BY	DATE				
	DRAFT WHERE APPLICABLE MUST REMAIN WITHIN DIMENSIONS	3 PLACES ± ---	± .015	APPROVED BY		DATE	 MOLEX INCORPORATED MATERIAL NO. SEE CHART DOCUMENT NO. SDA-7675-**** SHEET NO. 2 OF *		
2 PLACES ± 0.36		± .01	WRL		1986/02/14				
1 PLACE ± 0.25		± ---	ANGULAR ± 1/2°						
AZZ	REV			SIZE A		THIS DRAWING CONTAINS INFORMATION THAT IS PROPRIETARY TO MOLEX INCORPORATED AND SHOULD NOT BE USED WITHOUT WRITTEN PERMISSION			

A-7675-ANA		A-7675-BNA		A-7675-CNA		A-7675-DNA	
HOUSING	7674-AN	HOUSING	7674-BN	HOUSING	7674-CN	HOUSING	7674-DN
TERM. NO	40591-A(224)	TERM. NO	40591-A(224)	TERM. NO	40591-A(224)	TERM. NO	40591-A(224)
BACKWALL:	NO	BACKWALL:	NO	BACKWALL:	YES	BACKWALL:	YES
RAMP	NO	RAMP	YES	RAMP	NO	RAMP	YES
MOLD VOID IN CKT	NONE	MOLD VOID IN CKT	NONE	MOLD VOID IN CKT	NONE	MOLD VOID IN CKT	NONE
VOID TERM.IN CKT	NONE	VOID TERM.IN CKT	NONE	VOID TERM.IN CKT	NONE	VOID TERM.IN CKT	NONE
MATL NO	ENG NO:	MATL NO	ENG NO:	MATL NO	ENG NO:	MATL NO	ENG NO:
09-07-0027	A-7675-A02A	09-06-0027	A-7675-B02A	09-07-0028	A-7675-C02A	09-06-0028	A-7675-D02A
09-07-0037	A-7675-A03A	09-06-0037	A-7675-B03A	09-07-0038	A-7675-C03A	09-06-0038	A-7675-D03A
09-07-0047	A-7675-A04A	09-06-0047	A-7675-B04A	09-07-0048	A-7675-C04A	09-06-0048	A-7675-D04A
09-07-0057	A-7675-A05A	09-06-0057	A-7675-B05A	09-07-0058	A-7675-C05A	09-06-0058 50-36-1618	A-7675-D05A
09-07-0067	A-7675-A06A	09-06-0067	A-7675-B06A	09-07-0068	A-7675-C06A	09-06-0068	A-7675-D06A
09-07-0077	A-7675-A07A	09-06-0077	A-7675-B07A	09-07-0078	A-7675-C07A	09-06-0078	A-7675-D07A
09-07-0087	A-7675-A08A	09-06-0087	A-7675-B08A	09-07-0088	A-7675-C08A	09-06-0088	A-7675-D08A
09-07-0097	A-7675-A09A	09-06-0097	A-7675-B09A	09-07-0098	A-7675-C09A	09-06-0098	A-7675-D09A
09-07-0107	A-7675-A10A	09-06-0107	A-7675-B10A	09-07-0108	A-7675-C10A	09-06-0108	A-7675-D10A
09-07-0117	A-7675-A11A	09-06-0117	A-7675-B11A	09-07-0118	A-7675-C11A	09-06-0118	A-7675-D11A
09-07-0127	A-7675-A12A	09-06-0127	A-7675-B12A	09-07-0128	A-7675-C12A	09-06-0128	A-7675-D12A
09-07-0137	A-7675-A13A	09-06-0137	A-7675-B13A	09-07-0138	A-7675-C13A	09-06-0138	A-7675-D13A
09-07-0147	A-7675-A14A	09-06-0147	A-7675-B14A	09-07-0148	A-7675-C14A	09-06-0148	A-7675-D14A
09-07-0157	A-7675-A15A	09-06-0157	A-7675-B15A	09-07-0158	A-7675-C15A	09-06-0158	A-7675-D15A
09-07-0167	A-7675-A16A	09-06-0167	A-7675-B16A	09-07-0168	A-7675-C16A	09-06-0168	A-7675-D16A
09-07-0177	A-7675-A17A	09-06-0177	A-7675-B17A	09-07-0178	A-7675-C17A	09-06-0178	A-7675-D17A
09-07-0187	A-7675-A18A	09-06-0187	A-7675-B18A	09-07-0188	A-7675-C18A	09-06-0188	A-7675-D18A
09-07-0197	A-7675-A19A	09-06-0197	A-7675-B19A	09-07-0198	A-7675-C19A	09-06-0198	A-7675-D19A
09-07-0207	A-7675-A20A	09-06-0207	A-7675-B20A	09-07-0208	A-7675-C20A	09-06-0208	A-7675-D20A
09-07-0217	A-7675-A21A	09-06-0217	A-7675-B21A	09-07-0218	A-7675-C21A	09-06-0218	A-7675-D21A
09-07-0227	A-7675-A22A	09-06-0227	A-7675-B22A	09-07-0228	A-7675-C22A	09-06-0228	A-7675-D22A
09-07-0237	A-7675-A23A	09-06-0237	A-7675-B23A	09-07-0238	A-7675-C23A	09-06-0238	A-7675-D23A
09-07-0247	A-7675-A24A	09-06-0247	A-7675-B24A	09-07-0248	A-7675-C24A	09-06-0248	A-7675-D24A

REVISION: AZ3	ECR/ECN INFORMATION: EC No.: UCP2010-0214 DATE: 12/17/2009	TITLE: CONNECTOR ASSEMBLY KK (3.96)/.156 CENTER INSULATION DISPLACEMENT	SHEET No. 3
DOCUMENT NUMBER: SDA-7675-****	CREATED / REVISED BY: MKIPPER	CHECKED BY: SSOUSEK	APPROVED BY: FSMITH

A-7675-ANAA		A-7675-BNAA		A-7675-CNAA		A-7675-DNAA	
HOUSING	7674-ANAA	HOUSING	7674-BNAA	HOUSING	7674-CNAA	HOUSING	7674-DNAA
TERM. NO	40591-A(502)	TERM. NO	40591-A(502)	TERM. NO	40591-A(502)	TERM. NO	40591-A(502)
BACKWALL:	NO	BACKWALL:	NO	BACKWALL:	YES	BACKWALL:	YES
RAMP	NO	RAMP	YES	RAMP	NO	RAMP	YES
MOLD VOID IN CKT	NONE	MOLD VOID IN CKT	NONE	MOLD VOID IN CKT	NONE	MOLD VOID IN CKT	NONE
VOID TERM.IN CKT	NONE	VOID TERM.IN CKT	NONE	VOID TERM.IN CKT	NONE	VOID TERM.IN CKT	NONE
MATL NO	ENG NO:	MATL NO	ENG NO:	MATL NO	ENG NO:	MATL NO	ENG NO:
	A-7675-A02AA		A-7675-B02AA		A-7675-C02AA		A-7675-D02AA
	A-7675-A03AA		A-7675-B03AA		A-7675-C03AA		A-7675-D03AA
	A-7675-A04AA		A-7675-B04AA		A-7675-C04AA		A-7675-D04AA
	A-7675-A05AA		A-7675-B05AA		A-7675-C05AA		A-7675-D05AA
	A-7675-A06AA		A-7675-B06AA		A-7675-C06AA		A-7675-D06AA
	A-7675-A07AA		A-7675-B07AA		A-7675-C07AA		A-7675-D07AA
	A-7675-A08AA		A-7675-B08AA		A-7675-C08AA		A-7675-D08AA
	A-7675-A09AA		A-7675-B09AA		A-7675-C09AA		A-7675-D09AA
	A-7675-A10AA		A-7675-B10AA	26-32-0103	A-7675-C10AA		A-7675-D10AA
	A-7675-A11AA		A-7675-B11AA		A-7675-C11AA		A-7675-D11AA
	A-7675-A12AA		A-7675-B12AA		A-7675-C12AA		A-7675-D12AA
	A-7675-A13AA		A-7675-B13AA		A-7675-C13AA		A-7675-D13AA
	A-7675-A14AA		A-7675-B14AA		A-7675-C14AA		A-7675-D14AA
	A-7675-A15AA		A-7675-B15AA		A-7675-C15AA		A-7675-D15AA
	A-7675-A16AA		A-7675-B16AA	26-32-0163	A-7675-C16AA		A-7675-D16AA
	A-7675-A17AA		A-7675-B17AA		A-7675-C17AA		A-7675-D17AA
	A-7675-A18AA		A-7675-B18AA		A-7675-C18AA		A-7675-D18AA
	A-7675-A19AA		A-7675-B19AA		A-7675-C19AA		A-7675-D19AA
	A-7675-A20AA		A-7675-B20AA		A-7675-C20AA		A-7675-D20AA
	A-7675-A21AA		A-7675-B21AA		A-7675-C21AA		A-7675-D21AA
	A-7675-A22AA		A-7675-B22AA		A-7675-C22AA		A-7675-D22AA
	A-7675-A23AA		A-7675-B23AA		A-7675-C23AA		A-7675-D23AA
	A-7675-A24AA		A-7675-B24AA		A-7675-C24AA		A-7675-D24AA

REVISION: AZ3	ECR/ECN INFORMATION: EC No.: UCP2010-0214 DATE: 12/17/2009	TITLE: CONNECTOR ASSEMBLY KK (3.96)/.156 CENTER INSULATION DISPLACEMENT	SHEET No. 4
DOCUMENT NUMBER: SDA-7675-****	CREATED / REVISED BY: MKIPPER	CHECKED BY: SSOUSEK	APPROVED BY: FSMITH

A-7675-ANAH		A-7675-BNAH		A-7675-CNAH		A-7675-DNAH		
HOUSING	7674-ANAH	HOUSING	7674-BNAH	HOUSING	7674-CNAH	HOUSING	7674-DNAH	
TERM. NO	40591-A(555)	TERM. NO	40591-A(555)	TERM. NO	40591-A(555)	TERM. NO	40591-A(555)	
BACKWALL:	NO	BACKWALL:	NO	BACKWALL:	YES	BACKWALL:	YES	
RAMP	NO	RAMP	YES	RAMP	NO	RAMP	YES	
MOLD VOID IN CKT	NONE	MOLD VOID IN CKT	NONE	MOLD VOID IN CKT	NONE	MOLD VOID IN CKT	NONE	
VOID TERM.IN CKT	NONE	VOID TERM.IN CKT	NONE	VOID TERM.IN CKT	NONE	VOID TERM.IN CKT	NONE	
MATL NO	ENG NO:	MATL NO	ENG NO:	MATL NO	ENG NO:	MATL NO	ENG NO:	
	A-7675-A02AH	26-32-9024	A-7675-B02AH		A-7675-C02AH	26-32-9020	A-7675-D02AH	
	A-7675-A03AH	26-32-9034	A-7675-B03AH		A-7675-C03AH	26-32-9030	A-7675-D03AH	
	A-7675-A04AH	26-32-9044	A-7675-B04AH		A-7675-C04AH	26-32-9040	A-7675-D04AH	
	A-7675-A05AH		A-7675-B05AH		A-7675-C05AH	26-32-9050	A-7675-D05AH	
	A-7675-A06AH	26-32-9064	A-7675-B06AH		A-7675-C06AH	26-32-9060	A-7675-D06AH	
	A-7675-A07AH		A-7675-B07AH		A-7675-C07AH	26-32-9070	A-7675-D07AH	
	A-7675-A08AH	26-32-9084	A-7675-B08AH		A-7675-C08AH	26-32-9080	A-7675-D08AH	
	A-7675-A09AH		A-7675-B09AH		A-7675-C09AH	26-32-9090	A-7675-D09AH	
	A-7675-A10AH		A-7675-B10AH		A-7675-C10AH	26-32-9100	A-7675-D10AH	
	A-7675-A11AH		A-7675-B11AH		A-7675-C11AH	26-32-9110	A-7675-D11AH	
	A-7675-A12AH		A-7675-B12AH		A-7675-C12AH	26-32-9120	A-7675-D12AH	
	A-7675-A13AH		A-7675-B13AH		A-7675-C13AH	26-32-9130	A-7675-D13AH	
	A-7675-A14AH		A-7675-B14AH		A-7675-C14AH	26-32-9140	A-7675-D14AH	
	A-7675-A15AH		A-7675-B15AH		A-7675-C15AH	26-32-9150	A-7675-D15AH	
	A-7675-A16AH		A-7675-B16AH		A-7675-C16AH	26-32-9160	A-7675-D16AH	
	A-7675-A17AH		A-7675-B17AH		A-7675-C17AH	26-32-9170	A-7675-D17AH	
	A-7675-A18AH		A-7675-B18AH		A-7675-C18AH	26-32-9180	A-7675-D18AH	
	A-7675-A19AH		A-7675-B19AH		A-7675-C19AH	26-32-9190	A-7675-D19AH	
	A-7675-A20AH		A-7675-B20AH		A-7675-C20AH	26-32-9200	A-7675-D20AH	
	A-7675-A21AH		A-7675-B21AH		A-7675-C21AH	26-32-9210	A-7675-D21AH	
	A-7675-A22AH		A-7675-B22AH		A-7675-C22AH	26-32-9220	A-7675-D22AH	
	A-7675-A23AH		A-7675-B23AH		A-7675-C23AH	26-32-9230	A-7675-D23AH	
	A-7675-A24AH		A-7675-B24AH		A-7675-C24AH	26-32-9240	A-7675-D24AH	
REVISION: AZ3	ECR/ECN INFORMATION: EC No.: UCP2010-0214 DATE: 12/17/2009		TITLE: CONNECTOR ASSEMBLY KK (3.96)/.156 CENTER INSULATION DISPLACEMENT				SHEET No. 5	
DOCUMENT NUMBER: SDA-7675-****			CREATED / REVISED BY: MKIPPER		CHECKED BY: SSOUSEK		APPROVED BY: FSMITH	

A-7675-AND		A-7675-BND		A-7675-CND		A-7675-DND	
HOUSING	7674-AN	HOUSING	7674-BN	HOUSING	7674-CN	HOUSING	7674-DN
TERM. NO	40591-D(102)	TERM. NO	40591-D(102)	TERM. NO	40591-D(102)	TERM. NO	40591-D(102)
BACKWALL:	NO	BACKWALL:	NO	BACKWALL:	YES	BACKWALL:	YES
RAMP	NO	RAMP	YES	RAMP	NO	RAMP	YES
MOLD VOID IN CKT	NONE	MOLD VOID IN CKT	NONE	MOLD VOID IN CKT	NONE	MOLD VOID IN CKT	NONE
VOID TERM.IN CKT	NONE	VOID TERM.IN CKT	NONE	VOID TERM.IN CKT	NONE	VOID TERM.IN CKT	NONE
MATL NO	ENG NO:	MATL NO	ENG NO:	MATL NO	ENG NO:	MATL NO	ENG NO:
09-07-3027	A-7675-A02D	09-06-3027	A-7675-B02D	09-07-3028	A-7675-C02D	09-06-3028	A-7675-D02D
09-07-3037	A-7675-A03D	09-06-3037	A-7675-B03D	09-07-3038	A-7675-C03D	09-06-3038	A-7675-D03D
09-07-3047	A-7675-A04D	09-06-3047	A-7675-B04D	09-07-3048	A-7675-C04D	09-06-3048	A-7675-D04D
09-07-3057	A-7675-A05D	09-06-3057	A-7675-B05D	09-07-3058	A-7675-C05D	09-06-3058	A-7675-D05D
09-07-3067	A-7675-A06D	09-06-3067	A-7675-B06D	09-07-3068	A-7675-C06D	09-06-3068	A-7675-D06D
09-07-3077	A-7675-A07D	09-06-3077	A-7675-B07D	09-07-3078	A-7675-C07D	09-06-3078	A-7675-D07D
09-07-3087	A-7675-A08D	09-06-3087	A-7675-B08D	09-07-3088	A-7675-C08D	09-06-3088	A-7675-D08D
09-07-3097	A-7675-A09D	09-06-3097	A-7675-B09D	09-07-3098	A-7675-C09D	09-06-3098	A-7675-D09D
09-07-3107	A-7675-A10D	09-06-3107	A-7675-B10D	09-07-3108	A-7675-C10D	09-06-3108	A-7675-D10D
09-07-3117	A-7675-A11D	09-06-3117	A-7675-B11D	09-07-3118	A-7675-C11D	09-06-3118	A-7675-D11D
09-07-3127	A-7675-A12D	09-06-3127	A-7675-B12D	09-07-3128	A-7675-C12D	09-06-3128	A-7675-D12D
09-07-3137	A-7675-A13D	09-06-3137	A-7675-B13D	09-07-3138	A-7675-C13D	09-06-3138	A-7675-D13D
09-07-3147	A-7675-A14D	09-06-3147	A-7675-B14D	09-07-3148	A-7675-C14D	09-06-3148	A-7675-D14D
09-07-3157	A-7675-A15D	09-06-3157	A-7675-B15D	09-07-3158	A-7675-C15D	09-06-3158	A-7675-D15D
09-07-3167	A-7675-A16D	09-06-3167	A-7675-B16D	09-07-3168	A-7675-C16D	09-06-3168	A-7675-D16D
09-07-3177	A-7675-A17D	09-06-3177	A-7675-B17D	09-07-3178	A-7675-C17D	09-06-3178	A-7675-D17D
09-07-3187	A-7675-A18D	09-06-3187	A-7675-B18D	09-07-3188	A-7675-C18D	09-06-3188	A-7675-D18D
09-07-3197	A-7675-A19D	09-06-3197	A-7675-B19D	09-07-3198	A-7675-C19D	09-06-3198	A-7675-D19D
09-07-3207	A-7675-A20D	09-06-3207	A-7675-B20D	09-07-3208	A-7675-C20D	09-06-3208	A-7675-D20D
09-07-3217	A-7675-A21D	09-06-3217	A-7675-B21D	09-07-3218	A-7675-C21D	09-06-3218	A-7675-D21D
09-07-3227	A-7675-A22D	09-06-3227	A-7675-B22D	09-07-3228	A-7675-C22D	09-06-3228	A-7675-D22D
09-07-3237	A-7675-A23D	09-06-3237	A-7675-B23D	09-07-3238	A-7675-C23D	09-06-3238	A-7675-D23D
09-07-3247	A-7675-A24D	09-06-3247	A-7675-B24D	09-07-3248	A-7675-C24D	09-06-3248	A-7675-D24D

REVISION: AZ3	ECR/ECN INFORMATION: EC No.: UCP2010-0214 DATE: 12/17/2009	TITLE: CONNECTOR ASSEMBLY KK (3.96)/.156 CENTER INSULATION DISPLACEMENT	SHEET No. 7
DOCUMENT NUMBER: SDA-7675-****	CREATED / REVISED BY: MKIPPER	CHECKED BY: SSOUSEK	APPROVED BY: FSMITH

A-7675-ANDA		A-7675-BNDA		A-7675-CNDA		A-7675-DNDA	
HOUSING	7674-AN	HOUSING	7674-BN	HOUSING	7674-CN	HOUSING	7674-DN
TERM. NO	40591-D(502)	TERM. NO	40591-D(502)	TERM. NO	40591-D(502)	TERM. NO	40591-D(502)
BACKWALL:	NO	BACKWALL:	NO	BACKWALL:	YES	BACKWALL:	YES
RAMP	NO	RAMP	YES	RAMP	NO	RAMP	YES
MOLD VOID IN CKT	NONE	MOLD VOID IN CKT	NONE	MOLD VOID IN CKT	NONE	MOLD VOID IN CKT	NONE
VOID TERM.IN CKT	NONE	VOID TERM.IN CKT	NONE	VOID TERM.IN CKT	NONE	VOID TERM.IN CKT	NONE
MATL NO	ENG NO:	MATL NO	ENG NO:	MATL NO	ENG NO:	MATL NO	ENG NO:
	A-7675-A02DA		A-7675-B02DA		A-7675-C02DA		A-7675-D02DA
	A-7675-A03DA		A-7675-B03DA		A-7675-C03DA		A-7675-D03DA
	A-7675-A04DA		A-7675-B04DA		A-7675-C04DA		A-7675-D04DA
	A-7675-A05DA		A-7675-B05DA		A-7675-C05DA		A-7675-D05DA
	A-7675-A06DA		A-7675-B06DA	26-32-3068	A-7675-C06DA		A-7675-D06DA
	A-7675-A07DA		A-7675-B07DA		A-7675-C07DA		A-7675-D07DA
	A-7675-A08DA		A-7675-B08DA		A-7675-C08DA	26-32-3089	A-7675-D08DA
	A-7675-A09DA		A-7675-B09DA		A-7675-C09DA		A-7675-D09DA
	A-7675-A10DA		A-7675-B10DA		A-7675-C10DA		A-7675-D10DA
	A-7675-A11DA		A-7675-B11DA		A-7675-C11DA		A-7675-D11DA
	A-7675-A12DA		A-7675-B12DA		A-7675-C12DA		A-7675-D12DA
	A-7675-A13DA		A-7675-B13DA		A-7675-C13DA		A-7675-D13DA
	A-7675-A14DA		A-7675-B14DA		A-7675-C14DA		A-7675-D14DA
	A-7675-A15DA		A-7675-B15DA		A-7675-C15DA		A-7675-D15DA
	A-7675-A16DA		A-7675-B16DA		A-7675-C16DA		A-7675-D16DA
	A-7675-A17DA		A-7675-B17DA		A-7675-C17DA		A-7675-D17DA
	A-7675-A18DA		A-7675-B18DA		A-7675-C18DA		A-7675-D18DA
	A-7675-A19DA		A-7675-B19DA		A-7675-C19DA		A-7675-D19DA
	A-7675-A20DA		A-7675-B20DA		A-7675-C20DA		A-7675-D20DA
	A-7675-A21DA		A-7675-B21DA		A-7675-C21DA		A-7675-D21DA
	A-7675-A22DA		A-7675-B22DA		A-7675-C22DA		A-7675-D22DA
	A-7675-A23DA		A-7675-B23DA		A-7675-C23DA		A-7675-D23DA
	A-7675-A24DA		A-7675-B24DA		A-7675-C24DA		A-7675-D24DA
REVISION: AZ3	ECR/ECN INFORMATION: EC No.: UCP2010-0214 DATE: 12/17/2009		TITLE: CONNECTOR ASSEMBLY KK (3.96)/.156 CENTER INSULATION DISPLACEMENT			SHEET No. 8	
DOCUMENT NUMBER: SDA-7675-****		CREATED / REVISED BY: MKIPPER		CHECKED BY: SSOUSEK		APPROVED BY: FSMITH	

A-7675-ANJ		A-7675-BNJ		A-7675-CNJ		A-7675-DNJ	
HOUSING	7674-AN	HOUSING	7674-BN	HOUSING	7674-CN	HOUSING	7674-DN
TERM. NO	40591-J(102)	TERM. NO	40591-J(102)	TERM. NO	40591-J(102)	TERM. NO	40591-J(102)
BACKWALL:	NO	BACKWALL:	NO	BACKWALL:	YES	BACKWALL:	YES
RAMP	NO	RAMP	YES	RAMP	NO	RAMP	YES
MOLD VOID IN CKT	NONE	MOLD VOID IN CKT	NONE	MOLD VOID IN CKT	NONE	MOLD VOID IN CKT	NONE
VOID TERM.IN CKT	NONE	VOID TERM.IN CKT	NONE	VOID TERM.IN CKT	NONE	VOID TERM.IN CKT	NONE
MATL NO	ENG NO:	MATL NO	ENG NO:	MATL NO	ENG NO:	MATL NO	ENG NO:
09-07-5027	A-7675-A02J	09-06-5027	A-7675-B02J	09-07-5028	A-7675-C02J	09-06-5028	A-7675-D02J
09-07-5037	A-7675-A03J	09-06-5037	A-7675-B03J	09-07-5038	A-7675-C03J	09-06-5038	A-7675-D03J
09-07-5047	A-7675-A04J	09-06-5047	A-7675-B04J	09-07-5048	A-7675-C04J	09-06-5048	A-7675-D04J
09-07-5057	A-7675-A05J	09-06-5057	A-7675-B05J	09-07-5058	A-7675-C05J	09-06-5058	A-7675-D05J
09-07-5067	A-7675-A06J	09-06-5067	A-7675-B06J	09-07-5068	A-7675-C06J	09-06-5068	A-7675-D06J
09-07-5077	A-7675-A07J	09-06-5077	A-7675-B07J	09-07-5078	A-7675-C07J	09-06-5078	A-7675-D07J
09-07-5087	A-7675-A08J	09-06-5087	A-7675-B08J	09-07-5088	A-7675-C08J	09-06-5088	A-7675-D08J
09-07-5097	A-7675-A09J	09-06-5097	A-7675-B09J	09-07-5098	A-7675-C09J	09-06-5098	A-7675-D09J
09-07-5107	A-7675-A10J	09-06-5107	A-7675-B10J	09-07-5108	A-7675-C10J	09-06-5108	A-7675-D10J
09-07-5117	A-7675-A11J	09-06-5117	A-7675-B11J	09-07-5118	A-7675-C11J	09-06-5118	A-7675-D11J
09-07-5127	A-7675-A12J	09-06-5127	A-7675-B12J	09-07-5128	A-7675-C12J	09-06-5128	A-7675-D12J
09-07-5137	A-7675-A13J	09-06-5137	A-7675-B13J	09-07-5138	A-7675-C13J	09-06-5138	A-7675-D13J
09-07-5147	A-7675-A14J	09-06-5147	A-7675-B14J	09-07-5148	A-7675-C14J	09-06-5148	A-7675-D14J
09-07-5157	A-7675-A15J	09-06-5157	A-7675-B15J	09-07-5158	A-7675-C15J	09-06-5158	A-7675-D15J
09-07-5167	A-7675-A16J	09-06-5167	A-7675-B16J	09-07-5168	A-7675-C16J	09-06-5168	A-7675-D16J
09-07-5177	A-7675-A17J	09-06-5177	A-7675-B17J	09-07-5178	A-7675-C17J	09-06-5178	A-7675-D17J
09-07-5187	A-7675-A18J	09-06-5187	A-7675-B18J	09-07-5188	A-7675-C18J	09-06-5188	A-7675-D18J
09-07-5197	A-7675-A19J	09-06-5197	A-7675-B19J	09-07-5198	A-7675-C19J	09-06-5198	A-7675-D19J
09-07-5207	A-7675-A20J	09-06-5207	A-7675-B20J	09-07-5208	A-7675-C20J	09-06-5208	A-7675-D20J
09-07-5217	A-7675-A21J	09-06-5217	A-7675-B21J	09-07-5218	A-7675-C21J	09-06-5218	A-7675-D21J
09-07-5227	A-7675-A22J	09-06-5227	A-7675-B22J	09-07-5228	A-7675-C22J	09-06-5228	A-7675-D22J
09-07-5237	A-7675-A23J	09-06-5237	A-7675-B23J	09-07-5238	A-7675-C23J	09-06-5238	A-7675-D23J
09-07-5247	A-7675-A24J	09-06-5247	A-7675-B24J	09-07-5248	A-7675-C24J	09-06-5248	A-7675-D24J

REVISION: AZ3	ECR/ECN INFORMATION: EC No.: UCP2010-0214 DATE: 12/17/2009	TITLE: CONNECTOR ASSEMBLY KK (3.96)/.156 CENTER INSULATION DISPLACEMENT	SHEET No. 9
DOCUMENT NUMBER: SDA-7675-****	CREATED / REVISED BY: MKIPPER	CHECKED BY: SSOUSEK	APPROVED BY: FSMITH

A-7675-ANJA		A-7675-BNJA		A-7675-CNJA		A-7675-DNJA		
HOUSING	7674-AN	HOUSING	7674-BN	HOUSING	7674-CN	HOUSING	7674-DN	
TERM. NO	40591-J(502)	TERM. NO	40591-J(502)	TERM. NO	40591-J(502)	TERM. NO	40591-J(502)	
BACKWALL:	NO	BACKWALL:	NO	BACKWALL:	YES	BACKWALL:	YES	
RAMP	NO	RAMP	YES	RAMP	NO	RAMP	YES	
MOLD VOID IN CKT	NONE	MOLD VOID IN CKT	NONE	MOLD VOID IN CKT	NONE	MOLD VOID IN CKT	NONE	
VOID TERM.IN CKT	NONE	VOID TERM.IN CKT	NONE	VOID TERM.IN CKT	NONE	VOID TERM.IN CKT	NONE	
MATL NO	ENG NO:	MATL NO	ENG NO:	MATL NO	ENG NO:	MATL NO	ENG NO:	
	A-7675-A02JA		A-7675-B02JA		A-7675-C02JA	26-31-5028	A-7675-D02JA	
	A-7675-A03JA		A-7675-B03JA		A-7675-C03JA	26-31-5038	A-7675-D03JA	
	A-7675-A04JA		A-7675-B04JA	26-32-5048	A-7675-C04JA	26-31-5048	A-7675-D04JA	
	A-7675-A05JA		A-7675-B05JA		A-7675-C05JA	26-31-5058	A-7675-D05JA	
26-32-5067	A-7675-A06JA		A-7675-B06JA	26-32-5068	A-7675-C06JA	26-31-5068	A-7675-D06JA	
	A-7675-A07JA		A-7675-B07JA		A-7675-C07JA		A-7675-D07JA	
	A-7675-A08JA	21-62-2001	A-7675-B08JA		A-7675-C08JA	26-31-5088	A-7675-D08JA	
	A-7675-A09JA		A-7675-B09JA		A-7675-C09JA		A-7675-D09JA	
	A-7675-A10JA		A-7675-B10JA		A-7675-C10JA	26-31-5108	A-7675-D10JA	
	A-7675-A11JA		A-7675-B11JA		A-7675-C11JA		A-7675-D11JA	
	A-7675-A12JA	26-32-5129	A-7675-B12JA		A-7675-C12JA		A-7675-D12JA	
	A-7675-A13JA		A-7675-B13JA		A-7675-C13JA		A-7675-D13JA	
	A-7675-A14JA		A-7675-B14JA		A-7675-C14JA		A-7675-D14JA	
	A-7675-A15JA		A-7675-B15JA		A-7675-C15JA	26-31-5158	A-7675-D15JA	
	A-7675-A16JA		A-7675-B16JA		A-7675-C16JA		A-7675-D16JA	
	A-7675-A17JA		A-7675-B17JA		A-7675-C17JA		A-7675-D17JA	
	A-7675-A18JA		A-7675-B18JA		A-7675-C18JA		A-7675-D18JA	
	A-7675-A19JA		A-7675-B19JA		A-7675-C19JA		A-7675-D19JA	
	A-7675-A20JA		A-7675-B20JA		A-7675-C20JA		A-7675-D20JA	
	A-7675-A21JA		A-7675-B21JA		A-7675-C21JA		A-7675-D21JA	
	A-7675-A22JA		A-7675-B22JA		A-7675-C22JA		A-7675-D22JA	
	A-7675-A23JA		A-7675-B23JA		A-7675-C23JA		A-7675-D23JA	
	A-7675-A24JA		A-7675-B24JA		A-7675-C24JA		A-7675-D24JA	
REVISION: AZ3	ECR/ECN INFORMATION: EC No.: UCP2010-0214 DATE: 12/17/2009		TITLE: CONNECTOR ASSEMBLY KK (3.96)/.156 CENTER INSULATION DISPLACEMENT				SHEET No. 10	
DOCUMENT NUMBER: SDA-7675-****			CREATED / REVISED BY: MKIPPER	CHECKED BY: SSOUSEK	APPROVED BY: FSMITH			

A-7675-ANJE		A-7675-BNJE		A-7675-CNJE		A-7675-DNJE	
HOUSING	7674-AN	HOUSING	7674-BN	HOUSING	7674-CN	HOUSING	7674-DN
TERM. NO	40591-J(565)	TERM. NO	40591-J(565)	TERM. NO	40591-J(565)	TERM. NO	40591-J(565)
BACKWALL:	NO	BACKWALL:	NO	BACKWALL:	YES	BACKWALL:	YES
RAMP	NO	RAMP	YES	RAMP	NO	RAMP	YES
MOLD VOID IN CKT	NONE	MOLD VOID IN CKT	NONE	MOLD VOID IN CKT	NONE	MOLD VOID IN CKT	NONE
VOID TERM.IN CKT	NONE	VOID TERM.IN CKT	NONE	VOID TERM.IN CKT	NONE	VOID TERM.IN CKT	NONE
MATL NO	ENG NO:	MATL NO	ENG NO:	MATL NO	ENG NO:	MATL NO	ENG NO:
	A-7675-A02JE		A-7675-B02JE		A-7675-C02JE		A-7675-D02JE
	A-7675-A03JE		A-7675-B03JE		A-7675-C03JE		A-7675-D03JE
	A-7675-A04JE		A-7675-B04JE		A-7675-C04JE		A-7675-D04JE
	A-7675-A05JE		A-7675-B05JE		A-7675-C05JE		A-7675-D05JE
26-38-5067	A-7675-A06JE		A-7675-B06JE	26-38-5068	A-7675-C06JE		A-7675-D06JE
	A-7675-A07JE		A-7675-B07JE		A-7675-C07JE		A-7675-D07JE
	A-7675-A08JE		A-7675-B08JE		A-7675-C08JE		A-7675-D08JE
	A-7675-A09JE		A-7675-B09JE		A-7675-C09JE		A-7675-D09JE
	A-7675-A10JE		A-7675-B10JE		A-7675-C10JE		A-7675-D10JE
	A-7675-A11JE		A-7675-B11JE		A-7675-C11JE		A-7675-D11JE
	A-7675-A12JE		A-7675-B12JE		A-7675-C12JE		A-7675-D12JE
	A-7675-A13JE		A-7675-B13JE		A-7675-C13JE		A-7675-D13JE
09-10-5149	A-7675-A14JE		A-7675-B14JE		A-7675-C14JE		A-7675-D14JE
	A-7675-A15JE		A-7675-B15JE		A-7675-C15JE		A-7675-D15JE
	A-7675-A16JE		A-7675-B16JE		A-7675-C16JE		A-7675-D16JE
	A-7675-A17JE		A-7675-B17JE		A-7675-C17JE		A-7675-D17JE
	A-7675-A18JE		A-7675-B18JE		A-7675-C18JE		A-7675-D18JE

REVISION: AZ3	ECR/ECN INFORMATION: EC No.: UCP2010-0214 DATE: 12/17/2009	TITLE: CONNECTOR ASSEMBLY KK (3.96)/.156 CENTER INSULATION DISPLACEMENT	SHEET No. 11
DOCUMENT NUMBER: SDA-7675-****	CREATED / REVISED BY: MKIPPER	CHECKED BY: SSOUSEK	APPROVED BY: FSMITH

A-7675-ANJH		A-7675-BNJH		A-7675-CNJH		A-7675-DNJH	
HOUSING	7674-AN	HOUSING	7674-BN	HOUSING	7674-CN	HOUSING	7674-DN
TERM. NO	40591-J(555)	TERM. NO	40591-J(555)	TERM. NO	40591-J(555)	TERM. NO	40591-J(555)
BACKWALL:	NO	BACKWALL:	NO	BACKWALL:	YES	BACKWALL:	YES
RAMP	NO	RAMP	YES	RAMP	NO	RAMP	YES
MOLD VOID IN CKT	NONE	MOLD VOID IN CKT	NONE	MOLD VOID IN CKT	NONE	MOLD VOID IN CKT	NONE
VOID TERM.IN CKT	NONE	VOID TERM.IN CKT	NONE	VOID TERM.IN CKT	NONE	VOID TERM.IN CKT	NONE
MATL NO	ENG NO:	MATL NO	ENG NO:	MATL NO	ENG NO:	MATL NO	ENG NO:
	A-7675-A02JH		A-7675-B02JH		A-7675-C02JH	26-32-9025	A-7675-D02JH
	A-7675-A03JH		A-7675-B03JH		A-7675-C03JH		A-7675-D03JH
	A-7675-A04JH		A-7675-B04JH		A-7675-C04JH		A-7675-D04JH
	A-7675-A05JH		A-7675-B05JH		A-7675-C05JH		A-7675-D05JH
	A-7675-A06JH		A-7675-B06JH		A-7675-C06JH		A-7675-D06JH
	A-7675-A07JH		A-7675-B07JH		A-7675-C07JH		A-7675-D07JH
	A-7675-A08JH		A-7675-B08JH		A-7675-C08JH	26-32-9085	A-7675-D08JH
	A-7675-A09JH		A-7675-B09JH		A-7675-C09JH		A-7675-D09JH
	A-7675-A10JH		A-7675-B10JH		A-7675-C10JH		A-7675-D10JH
	A-7675-A11JH		A-7675-B11JH		A-7675-C11JH		A-7675-D11JH
	A-7675-A12JH		A-7675-B12JH		A-7675-C12JH		A-7675-D12JH
	A-7675-A13JH		A-7675-B13JH		A-7675-C13JH		A-7675-D13JH
	A-7675-A14JH		A-7675-B14JH		A-7675-C14JH		A-7675-D14JH
	A-7675-A15JH		A-7675-B15JH		A-7675-C15JH	26-32-9155	A-7675-D15JH
	A-7675-A16JH		A-7675-B16JH		A-7675-C16JH		A-7675-D16JH
	A-7675-A17JH		A-7675-B17JH		A-7675-C17JH		A-7675-D17JH
	A-7675-A18JH		A-7675-B18JH		A-7675-C18JH		A-7675-D18JH
	A-7675-A19JH		A-7675-B19JH		A-7675-C19JH		A-7675-D19JH
	A-7675-A20JH		A-7675-B20JH		A-7675-C20JH		A-7675-D20JH
	A-7675-A21JH		A-7675-B21JH		A-7675-C21JH		A-7675-D21JH
	A-7675-A22JH		A-7675-B22JH		A-7675-C22JH		A-7675-D22JH
	A-7675-A23JH		A-7675-B23JH		A-7675-C23JH		A-7675-D23JH
	A-7675-A24JH		A-7675-B24JH		A-7675-C24JH		A-7675-D24JH

REVISION: AZ3	ECR/ECN INFORMATION: EC No.: UCP2010-0214 DATE: 12/17/2009	TITLE: CONNECTOR ASSEMBLY KK (3.96)/.156 CENTER INSULATION DISPLACEMENT	SHEET No. 12
DOCUMENT NUMBER: SDA-7675-****	CREATED / REVISED BY: MKIPPER	CHECKED BY: SSOUSEK	APPROVED BY: FSMITH

A-7675-ANL		A-7675-BNL		A-7675-CNL		A-7675-DNL	
HOUSING	7674-AN	HOUSING	7674-BN	HOUSING	7674-CN	HOUSING	7674-DN
TERM. NO	40591-L(102)	TERM. NO	40591-L(102)	TERM. NO	40591-L(102)	TERM. NO	40591-L(102)
BACKWALL:	NO	BACKWALL:	NO	BACKWALL:	YES	BACKWALL:	YES
RAMP	NO	RAMP	YES	RAMP	NO	RAMP	YES
MOLD VOID IN CKT	NONE	MOLD VOID IN CKT	NONE	MOLD VOID IN CKT	NONE	MOLD VOID IN CKT	NONE
VOID TERM.IN CKT	NONE	VOID TERM.IN CKT	NONE	VOID TERM.IN CKT	NONE	VOID TERM.IN CKT	NONE
MATL NO	ENG NO:	MATL NO	ENG NO:	MATL NO	ENG NO:	MATL NO	ENG NO:
09-07-2027	A-7675-A02L	09-06-2027	A-7675-B02L	09-07-2028	A-7675-C02L	09-06-2028	A-7675-D02L
09-07-2037	A-7675-A03L	09-06-2037	A-7675-B03L	09-07-2038	A-7675-C03L	09-06-2038	A-7675-D03L
09-07-2047	A-7675-A04L	09-06-2047	A-7675-B04L	09-07-2048	A-7675-C04L	09-06-2048	A-7675-D04L
09-07-2057	A-7675-A05L	09-06-2057	A-7675-B05L	09-07-2058	A-7675-C05L	09-06-2058	A-7675-D05L
09-07-2067	A-7675-A06L	09-06-2067	A-7675-B06L	09-07-2068	A-7675-C06L	09-06-2068	A-7675-D06L
09-07-2077	A-7675-A07L	09-06-2077	A-7675-B07L	09-07-2078	A-7675-C07L	09-06-2078	A-7675-D07L
09-07-2087	A-7675-A08L	09-06-2087	A-7675-B08L	09-07-2088	A-7675-C08L	09-06-2088	A-7675-D08L
09-07-2097	A-7675-A09L	09-06-2097	A-7675-B09L	09-07-2098	A-7675-C09L	09-06-2098	A-7675-D09L
09-07-2107	A-7675-A10L	09-06-2107	A-7675-B10L	09-07-2108	A-7675-C10L	09-06-2108	A-7675-D10L
09-07-2117	A-7675-A11L	09-06-2117	A-7675-B11L	09-07-2118	A-7675-C11L	09-06-2118	A-7675-D11L
09-07-2127	A-7675-A12L	09-06-2127	A-7675-B12L	09-07-2128	A-7675-C12L	09-06-2128	A-7675-D12L
09-07-2137	A-7675-A13L	09-06-2137	A-7675-B13L	09-07-2138	A-7675-C13L	09-06-2138	A-7675-D13L
09-07-2147	A-7675-A14L	09-06-2147	A-7675-B14L	09-07-2148	A-7675-C14L	09-06-2148	A-7675-D14L
09-07-2157	A-7675-A15L	09-06-2157	A-7675-B15L	09-07-2158	A-7675-C15L	09-06-2158	A-7675-D15L
09-07-2167	A-7675-A16L	09-06-2167	A-7675-B16L	09-07-2168	A-7675-C16L	09-06-2168	A-7675-D16L
09-07-2177	A-7675-A17L	09-06-2177	A-7675-B17L	09-07-2178	A-7675-C17L	09-06-2178	A-7675-D17L
09-07-2187	A-7675-A18L	09-06-2187	A-7675-B18L	09-07-2188	A-7675-C18L	09-06-2188	A-7675-D18L
09-07-2197	A-7675-A19L	09-06-2197	A-7675-B19L	09-07-2198	A-7675-C19L	09-06-2198	A-7675-D19L
09-07-2207	A-7675-A20L	09-06-2207	A-7675-B20L	09-07-2208	A-7675-C20L	09-06-2208	A-7675-D20L
09-07-2217	A-7675-A21L	09-06-2217	A-7675-B21L	09-07-2218	A-7675-C21L	09-06-2218	A-7675-D21L
09-07-2227	A-7675-A22L	09-06-2227	A-7675-B22L	09-07-2228	A-7675-C22L	09-06-2228	A-7675-D22L
09-07-2237	A-7675-A23L	09-06-2237	A-7675-B23L	09-07-2238	A-7675-C23L	09-06-2238	A-7675-D23L
09-07-2247	A-7675-A24L	09-06-2247	A-7675-B24L	09-07-2248	A-7675-C24L	09-06-2248	A-7675-D24L

REVISION: AZ3	ECR/ECN INFORMATION: EC No.: UCP2010-0214 DATE: 12/17/2009	TITLE: CONNECTOR ASSEMBLY KK (3.96)/.156 CENTER INSULATION DISPLACEMENT	SHEET No. 14
DOCUMENT NUMBER: SDA-7675-****	CREATED / REVISED BY: MKIPPER	CHECKED BY: SSOUSEK	APPROVED BY: FSMITH

A-7675-ANLA		A-7675-BNLA		A-7675-CNLA		A-7675-DNLA	
HOUSING	7674-AN	HOUSING	7674-BN	HOUSING	7674-CN	HOUSING	7674-DN
TERM. NO	40591-L(502)	TERM. NO	40591-L(502)	TERM. NO	40591-L(502)	TERM. NO	40591-L(502)
BACKWALL:	NO	BACKWALL:	NO	BACKWALL:	YES	BACKWALL:	YES
RAMP	NO	RAMP	YES	RAMP	NO	RAMP	YES
MOLD VOID IN CKT	NONE	MOLD VOID IN CKT	NONE	MOLD VOID IN CKT	NONE	MOLD VOID IN CKT	NONE
VOID TERM.IN CKT	NONE	VOID TERM.IN CKT	NONE	VOID TERM.IN CKT	NONE	VOID TERM.IN CKT	NONE
MATL NO	ENG NO:	MATL NO	ENG NO:	MATL NO	ENG NO:	MATL NO	ENG NO:
	A-7675-A02LA		A-7675-B02LA		A-7675-C02LA	26-31-2028	A-7675-D02LA
	A-7675-A03LA		A-7675-B03LA		A-7675-C03LA		A-7675-D03LA
	A-7675-A04LA		A-7675-B04LA		A-7675-C04LA		A-7675-D04LA
	A-7675-A05LA		A-7675-B05LA		A-7675-C05LA		A-7675-D05LA
	A-7675-A06LA		A-7675-B06LA		A-7675-C06LA		A-7675-D06LA
	A-7675-A07LA		A-7675-B07LA		A-7675-C07LA		A-7675-D07LA
	A-7675-A08LA		A-7675-B08LA		A-7675-C08LA		A-7675-D08LA
	A-7675-A09LA		A-7675-B09LA		A-7675-C09LA		A-7675-D09LA
	A-7675-A10LA		A-7675-B10LA		A-7675-C10LA		A-7675-D10LA
	A-7675-A11LA		A-7675-B11LA		A-7675-C11LA		A-7675-D11LA
	A-7675-A12LA		A-7675-B12LA		A-7675-C12LA		A-7675-D12LA
	A-7675-A13LA		A-7675-B13LA		A-7675-C13LA		A-7675-D13LA
	A-7675-A14LA		A-7675-B14LA		A-7675-C14LA	26-31-2148	A-7675-D14LA
	A-7675-A15LA		A-7675-B15LA		A-7675-C15LA		A-7675-D15LA
	A-7675-A16LA		A-7675-B16LA		A-7675-C16LA		A-7675-D16LA
	A-7675-A17LA		A-7675-B17LA		A-7675-C17LA		A-7675-D17LA
	A-7675-A18LA		A-7675-B18LA		A-7675-C18LA		A-7675-D18LA
	A-7675-A19LA		A-7675-B19LA		A-7675-C19LA		A-7675-D19LA
	A-7675-A20LA	26-31-2207	A-7675-B20LA		A-7675-C20LA		A-7675-D20LA
	A-7675-A21LA		A-7675-B21LA		A-7675-C21LA		A-7675-D21LA
	A-7675-A22LA		A-7675-B22LA		A-7675-C22LA		A-7675-D22LA
	A-7675-A23LA		A-7675-B23LA		A-7675-C23LA		A-7675-D23LA
	A-7675-A24LA		A-7675-B24LA		A-7675-C24LA		A-7675-D24LA
REVISION: AZ3	ECR/ECN INFORMATION: EC No.: UCP2010-0214 DATE: 12/17/2009		TITLE:	CONNECTOR ASSEMBLY KK (3.96)/.156 CENTER INSULATION DISPLACEMENT			SHEET No. 15
DOCUMENT NUMBER: SDA-7675-****		CREATED / REVISED BY: MKIPPER		CHECKED BY: SSOUSEK		APPROVED BY: FSMITH	

A-7675-ANLD		A-7675-BNLD		A-7675-CNLD		A-7675-DNLD	
HOUSING	7674-AN	HOUSING	7674-BN	HOUSING	7674-CN	HOUSING	7674-DN
TERM. NO	40591-L(503)	TERM. NO	40591-L(503)	TERM. NO	40591-L(503)	TERM. NO	40591-L(503)
BACKWALL:	NO	BACKWALL:	NO	BACKWALL:	YES	BACKWALL:	YES
RAMP	NO	RAMP	YES	RAMP	NO	RAMP	YES
MOLD VOID IN CKT	NONE	MOLD VOID IN CKT	NONE	MOLD VOID IN CKT	NONE	MOLD VOID IN CKT	NONE
VOID TERM.IN CKT	NONE	VOID TERM.IN CKT	NONE	VOID TERM.IN CKT	NONE	VOID TERM.IN CKT	NONE
MATL NO	ENG NO:	MATL NO	ENG NO:	MATL NO	ENG NO:	MATL NO	ENG NO:
	A-7675-A02LD		A-7675-B02LD		A-7675-C02LD		A-7675-D02LD
	A-7675-A03LD		A-7675-B03LD		A-7675-C03LD		A-7675-D03LD
	A-7675-A04LD		A-7675-B04LD		A-7675-C04LD		A-7675-D04LD
	A-7675-A05LD		A-7675-B05LD		A-7675-C05LD	09-06-7055	A-7675-D05LD
	A-7675-A06LD		A-7675-B06LD		A-7675-C06LD		A-7675-D06LD
	A-7675-A07LD		A-7675-B07LD		A-7675-C07LD		A-7675-D07LD
	A-7675-A08LD		A-7675-B08LD		A-7675-C08LD		A-7675-D08LD
	A-7675-A09LD		A-7675-B09LD		A-7675-C09LD		A-7675-D09LD
	A-7675-A10LD		A-7675-B10LD		A-7675-C10LD		A-7675-D10LD
	A-7675-A11LD		A-7675-B11LD		A-7675-C11LD		A-7675-D11LD
	A-7675-A12LD		A-7675-B12LD		A-7675-C12LD		A-7675-D12LD
	A-7675-A13LD		A-7675-B13LD		A-7675-C13LD		A-7675-D13LD
	A-7675-A14LD		A-7675-B14LD		A-7675-C14LD		A-7675-D14LD
	A-7675-A15LD		A-7675-B15LD		A-7675-C15LD		A-7675-D15LD
	A-7675-A16LD		A-7675-B16LD		A-7675-C16LD		A-7675-D16LD
	A-7675-A17LD		A-7675-B17LD		A-7675-C17LD		A-7675-D17LD
	A-7675-A18LD		A-7675-B18LD		A-7675-C18LD		A-7675-D18LD
	A-7675-A19LD		A-7675-B19LD		A-7675-C19LD		A-7675-D19LD
	A-7675-A20LD		A-7675-B20LD		A-7675-C20LD		A-7675-D20LD
	A-7675-A21LD		A-7675-B21LD		A-7675-C21LD		A-7675-D21LD
	A-7675-A22LD		A-7675-B22LD		A-7675-C22LD		A-7675-D22LD
	A-7675-A23LD		A-7675-B23LD		A-7675-C23LD		A-7675-D23LD
	A-7675-A24LD		A-7675-B24LD		A-7675-C24LD	09-06-7245	A-7675-D24LD
REVISION: AZ3	ECR/ECN INFORMATION: EC No.: UCP2010-0214 DATE: 12/17/2009	TITLE: CONNECTOR ASSEMBLY KK (3.96)/.156 CENTER INSULATION DISPLACEMENT	SHEET No. 16				
DOCUMENT NUMBER: SDA-7675-****	CREATED / REVISED BY: MKIPPER	CHECKED BY: SSOUSEK	APPROVED BY: FSMITH				

A-7675-ANM		A-7675-BNM		A-7675-CNM		A-7675-DNM		
HOUSING	7674-AN	HOUSING	7674-BN	HOUSING	7674-CN	HOUSING	7674-DN	
TERM. NO	40591-M(102)	TERM. NO	40591-M(102)	TERM. NO	40591-M(102)	TERM. NO	40591-M(102)	
BACKWALL:	NO	BACKWALL:	NO	BACKWALL:	YES	BACKWALL:	YES	
RAMP	NO	RAMP	YES	RAMP	NO	RAMP	YES	
MOLD VOID IN CKT	NONE	MOLD VOID IN CKT	NONE	MOLD VOID IN CKT	NONE	MOLD VOID IN CKT	NONE	
VOID TERM.IN CKT	NONE	VOID TERM.IN CKT	NONE	VOID TERM.IN CKT	NONE	VOID TERM.IN CKT	NONE	
MATL NO	ENG NO:	MATL NO	ENG NO:	MATL NO	ENG NO:	MATL NO	ENG NO:	
09-07-1027	A-7675-A02M	09-06-1027	A-7675-B02M	09-07-1028	A-7675-C02M	09-06-1028	A-7675-D02M	
09-07-1037	A-7675-A03M	09-06-1037	A-7675-B03M	09-07-1038	A-7675-C03M	09-06-1038	A-7675-D03M	
09-07-1047	A-7675-A04M	09-06-1047	A-7675-B04M	09-07-1048	A-7675-C04M	09-06-1048	A-7675-D04M	
09-07-1057	A-7675-A05M	09-06-1057	A-7675-B05M	09-07-1058	A-7675-C05M	09-06-1058	A-7675-D05M	
09-07-1067	A-7675-A06M	09-06-1067	A-7675-B06M	09-07-1068	A-7675-C06M	09-06-1068	A-7675-D06M	
09-07-1077	A-7675-A07M	09-06-1077	A-7675-B07M	09-07-1078	A-7675-C07M	09-06-1078	A-7675-D07M	
09-07-1087	A-7675-A08M	09-06-1087	A-7675-B08M	09-07-1088	A-7675-C08M	09-06-1088	A-7675-D08M	
09-07-1097	A-7675-A09M	09-06-1097	A-7675-B09M	09-07-1098	A-7675-C09M	09-06-1098	A-7675-D09M	
09-07-1107	A-7675-A10M	09-06-1107	A-7675-B10M	09-07-1108	A-7675-C10M	09-06-1108	A-7675-D10M	
09-07-1117	A-7675-A11M	09-06-1117	A-7675-B11M	09-07-1118	A-7675-C11M	09-06-1118	A-7675-D11M	
09-07-1127	A-7675-A12M	09-06-1127	A-7675-B12M	09-07-1128	A-7675-C12M	09-06-1128	A-7675-D12M	
09-07-1137	A-7675-A13M	09-06-1137	A-7675-B13M	09-07-1138	A-7675-C13M	09-06-1138	A-7675-D13M	
09-07-1147	A-7675-A14M	09-06-1147	A-7675-B14M	09-07-1148	A-7675-C14M	09-06-1148	A-7675-D14M	
09-07-1157	A-7675-A15M	09-06-1157	A-7675-B15M	09-07-1158	A-7675-C15M	09-06-1158	A-7675-D15M	
09-07-1167	A-7675-A16M	09-06-1167	A-7675-B16M	09-07-1168	A-7675-C16M	09-06-1168	A-7675-D16M	
09-07-1177	A-7675-A17M	09-06-1177	A-7675-B17M	09-07-1178	A-7675-C17M	09-06-1178	A-7675-D17M	
09-07-1187	A-7675-A18M	09-06-1187	A-7675-B18M	09-07-1188	A-7675-C18M	09-06-1188	A-7675-D18M	
09-07-1197	A-7675-A19M	09-06-1197	A-7675-B19M	09-07-1198	A-7675-C19M	09-06-1198	A-7675-D19M	
09-07-1207	A-7675-A20M	09-06-1207	A-7675-B20M	09-07-1208	A-7675-C20M	09-06-1208	A-7675-D20M	
09-07-1217	A-7675-A21M	09-06-1217	A-7675-B21M	09-07-1218	A-7675-C21M	09-06-1218	A-7675-D21M	
09-07-1227	A-7675-A22M	09-06-1227	A-7675-B22M	09-07-1228	A-7675-C22M	09-06-1228	A-7675-D22M	
09-07-1237	A-7675-A23M	09-06-1237	A-7675-B23M	09-07-1238	A-7675-C23M	09-06-1238	A-7675-D23M	
09-07-1247	A-7675-A24M	09-06-1247	A-7675-B24M	09-07-1248	A-7675-C24M	09-06-1248	A-7675-D24M	
REVISION: AZ3	ECR/ECN INFORMATION: EC No.: UCP2010-0214 DATE: 12/17/2009		TITLE: CONNECTOR ASSEMBLY KK (3.96)/.156 CENTER INSULATION DISPLACEMENT				SHEET No. 17	
DOCUMENT NUMBER: SDA-7675-****			CREATED / REVISED BY: MKIPPER		CHECKED BY: SSOUSEK		APPROVED BY: FSMITH	

A-7675-ANMA		A-7675-BNMA		A-7675-CNMA		A-7675-DNMA	
HOUSING	7674-AN	HOUSING	7674-BN	HOUSING	7674-CN	HOUSING	7674-DN
TERM. NO	40591-M(502)	TERM. NO	40591-M(502)	TERM. NO	40591-M(502)	TERM. NO	40591-M(502)
BACKWALL:	NO	BACKWALL:	NO	BACKWALL:	YES	BACKWALL:	YES
RAMP	NO	RAMP	YES	RAMP	NO	RAMP	YES
MOLD VOID IN CKT	NONE	MOLD VOID IN CKT	NONE	MOLD VOID IN CKT	NONE	MOLD VOID IN CKT	NONE
VOID TERM.IN CKT	NONE	VOID TERM.IN CKT	NONE	VOID TERM.IN CKT	NONE	VOID TERM.IN CKT	NONE
MATL NO	ENG NO:	MATL NO	ENG NO:	MATL NO	ENG NO:	MATL NO	ENG NO:
	A-7675-A02MA		A-7675-B02MA		A-7675-C02MA		A-7675-D02MA
	A-7675-A03MA		A-7675-B03MA		A-7675-C03MA		A-7675-D03MA
	A-7675-A04MA		A-7675-B04MA		A-7675-C04MA		A-7675-D04MA
	A-7675-A05MA		A-7675-B05MA		A-7675-C05MA		A-7675-D05MA
	A-7675-A06MA		A-7675-B06MA		A-7675-C06MA		A-7675-D06MA
	A-7675-A07MA		A-7675-B07MA		A-7675-C07MA	26-32-1074	A-7675-D07MA
	A-7675-A08MA		A-7675-B08MA		A-7675-C08MA	26-32-1084	A-7675-D08MA
	A-7675-A09MA		A-7675-B09MA	09-07-7091	A-7675-C09MA		A-7675-D09MA
	A-7675-A10MA		A-7675-B10MA	26-32-1102	A-7675-C10MA	26-32-1104	A-7675-D10MA
	A-7675-A11MA		A-7675-B11MA		A-7675-C11MA		A-7675-D11MA
	A-7675-A12MA		A-7675-B12MA		A-7675-C12MA	26-32-1124	A-7675-D12MA
	A-7675-A13MA		A-7675-B13MA		A-7675-C13MA		A-7675-D13MA
26-32-1141	A-7675-A14MA	26-32-1143	A-7675-B14MA		A-7675-C14MA		A-7675-D14MA
	A-7675-A15MA	26-32-1153	A-7675-B15MA		A-7675-C15MA		A-7675-D15MA
	A-7675-A16MA		A-7675-B16MA	26-32-1162	A-7675-C16MA		A-7675-D16MA
	A-7675-A17MA		A-7675-B17MA		A-7675-C17MA		A-7675-D17MA
26-32-1181	A-7675-A18MA		A-7675-B18MA	26-32-1182	A-7675-C18MA		A-7675-D18MA
	A-7675-A19MA		A-7675-B19MA		A-7675-C19MA		A-7675-D19MA
26-32-1201	A-7675-A20MA	26-32-1203	A-7675-B20MA		A-7675-C20MA		A-7675-D20MA
	A-7675-A21MA		A-7675-B21MA		A-7675-C21MA		A-7675-D21MA
	A-7675-A22MA		A-7675-B22MA		A-7675-C22MA		A-7675-D22MA
	A-7675-A23MA		A-7675-B23MA		A-7675-C23MA		A-7675-D23MA
	A-7675-A24MA		A-7675-B24MA		A-7675-C24MA		A-7675-D24MA

REVISION: AZ3	ECR/ECN INFORMATION: EC No.: UCP2010-0214 DATE: 12/17/2009	TITLE: CONNECTOR ASSEMBLY KK (3.96)/.156 CENTER INSULATION DISPLACEMENT	SHEET No. 18
DOCUMENT NUMBER: SDA-7675-****	CREATED / REVISED BY: MKIPPER	CHECKED BY: SSOUSEK	APPROVED BY: FSMITH

A-7675-ANMH		A-7675-BNMH		A-7675-CNMH		A-7675-DNMH	
HOUSING	7674-AN	HOUSING	7674-BN	HOUSING	7674-CN	HOUSING	7674-DN
TERM. NO	40591-M(555)	TERM. NO	40591-M(555)	TERM. NO	40591-M(555)	TERM. NO	40591-M(555)
BACKWALL:	NO	BACKWALL:	NO	BACKWALL:	YES	BACKWALL:	YES
RAMP	NO	RAMP	YES	RAMP	NO	RAMP	YES
MOLD VOID IN CKT	NONE	MOLD VOID IN CKT	NONE	MOLD VOID IN CKT	NONE	MOLD VOID IN CKT	NONE
VOID TERM.IN CKT	NONE	VOID TERM.IN CKT	NONE	VOID TERM.IN CKT	NONE	VOID TERM.IN CKT	NONE
MATL NO	ENG NO:	MATL NO	ENG NO:	MATL NO	ENG NO:	MATL NO	ENG NO:
	A-7675-A02MH		A-7675-B02MH		A-7675-C02MH	26-32-7024	A-7675-D02MH
	A-7675-A03MH	26-32-7032	A-7675-B03MH		A-7675-C03MH	26-32-7034	A-7675-D03MH
	A-7675-A04MH		A-7675-B04MH		A-7675-C04MH	26-32-7044	A-7675-D04MH
	A-7675-A05MH		A-7675-B05MH		A-7675-C05MH	26-32-7054	A-7675-D05MH
	A-7675-A06MH	26-32-7062	A-7675-B06MH	26-32-7063	A-7675-C06MH	26-32-7064	A-7675-D06MH
	A-7675-A07MH		A-7675-B07MH		A-7675-C07MH	26-32-7074	A-7675-D07MH
	A-7675-A08MH	26-32-7082	A-7675-B08MH		A-7675-C08MH	26-32-7084	A-7675-D08MH
	A-7675-A09MH		A-7675-B09MH		A-7675-C09MH	26-32-7094	A-7675-D09MH
	A-7675-A10MH		A-7675-B10MH		A-7675-C10MH	26-32-7104	A-7675-D10MH
	A-7675-A11MH		A-7675-B11MH		A-7675-C11MH	26-32-7114	A-7675-D11MH
	A-7675-A12MH		A-7675-B12MH		A-7675-C12MH	26-32-7124	A-7675-D12MH
	A-7675-A13MH		A-7675-B13MH		A-7675-C13MH	26-32-7134	A-7675-D13MH
	A-7675-A14MH		A-7675-B14MH		A-7675-C14MH	26-32-7144	A-7675-D14MH
	A-7675-A15MH		A-7675-B15MH		A-7675-C15MH	26-32-7154	A-7675-D15MH
	A-7675-A16MH		A-7675-B16MH		A-7675-C16MH	26-32-7164	A-7675-D16MH
	A-7675-A17MH		A-7675-B17MH		A-7675-C17MH	26-32-7174	A-7675-D17MH
	A-7675-A18MH		A-7675-B18MH		A-7675-C18MH	26-32-7184	A-7675-D18MH
	A-7675-A19MH		A-7675-B19MH		A-7675-C19MH	26-32-7194	A-7675-D19MH
	A-7675-A20MH		A-7675-B20MH		A-7675-C20MH	26-32-7204	A-7675-D20MH
	A-7675-A21MH		A-7675-B21MH		A-7675-C21MH	26-32-7214	A-7675-D21MH
	A-7675-A22MH		A-7675-B22MH		A-7675-C22MH	26-32-7224	A-7675-D22MH
	A-7675-A23MH		A-7675-B23MH		A-7675-C23MH	26-32-7234	A-7675-D23MH
	A-7675-A24MH		A-7675-B24MH		A-7675-C24MH	26-32-7244	A-7675-D24MH
REVISION: AZ3	ECR/ECN INFORMATION: EC No.: UCP2010-0214 DATE: 12/17/2009	TITLE:	CONNECTOR ASSEMBLY KK (3.96)/.156 CENTER INSULATION DISPLACEMENT				SHEET No. 19
DOCUMENT NUMBER: SDA-7675-****	CREATED / REVISED BY: MKIPPER	CHECKED BY: SSOUSEK	APPROVED BY: FSMITH				

