



## Z-Bulk Metal® Foil Technology RNC90Z to MIL-PRF-55182/9



### INTRODUCTION

The RNC90Y has been the benchmark for high precision established reliability discrete resistors since 1982. In 2000, Vishay achieved a technological breakthrough with the introduction of the commercial ultra precision low TCR Z201 resistor. This breakthrough has now allowed Vishay to introduce an established reliability “R” level very low TCR resistor. The RNC90Z TCR limit of  $\pm 2 \text{ ppm}/^\circ\text{C}$  over the extended range of  $-55^\circ\text{C}$  to  $+175^\circ\text{C}$  is a significant improvement over the existing RNC90Y specification. The RNC90Z is a direct replacement for the RNC90Y.

### FEATURES

- QPL product with established reliability (ER): meets requirements of MIL-PRF-55182/9
- Temperature coefficient of resistance (TCR):  $\pm 2 \text{ ppm}/^\circ\text{C}$  max. ( $-55^\circ\text{C}$  to  $+175^\circ\text{C}$ )
- Load life stability: to 0.005 %, 0.3 W at  $+125^\circ\text{C}$  for 2000 h
- Resistance tolerance: to  $\pm 0.005 \%$
- Qualified resistance range: 30.1  $\Omega$  to 121 k $\Omega$  (for other values please check Z555)
- Electrostatic discharge (ESD) above 25 000 V
- Non inductive, non capacitive design
- Current noise  $< -42 \text{ dB}$
- Thermal EMF:  $< 0.1 \mu\text{V}/^\circ\text{C}$
- Fast thermal stabilization
- Rise time: 1 ns without ringing
- A radiation test has been performed in the past on Vishay's Foil Resistors
- Prototype samples available from 72 h
- “R” level high reliability resistor qualified to MIL-PRF-55182/9

**FIGURE 1 - COMPARISON OF RNC90Y TO RNC90Z TEMPERATURE COEFFICIENT OF RESISTANCE**

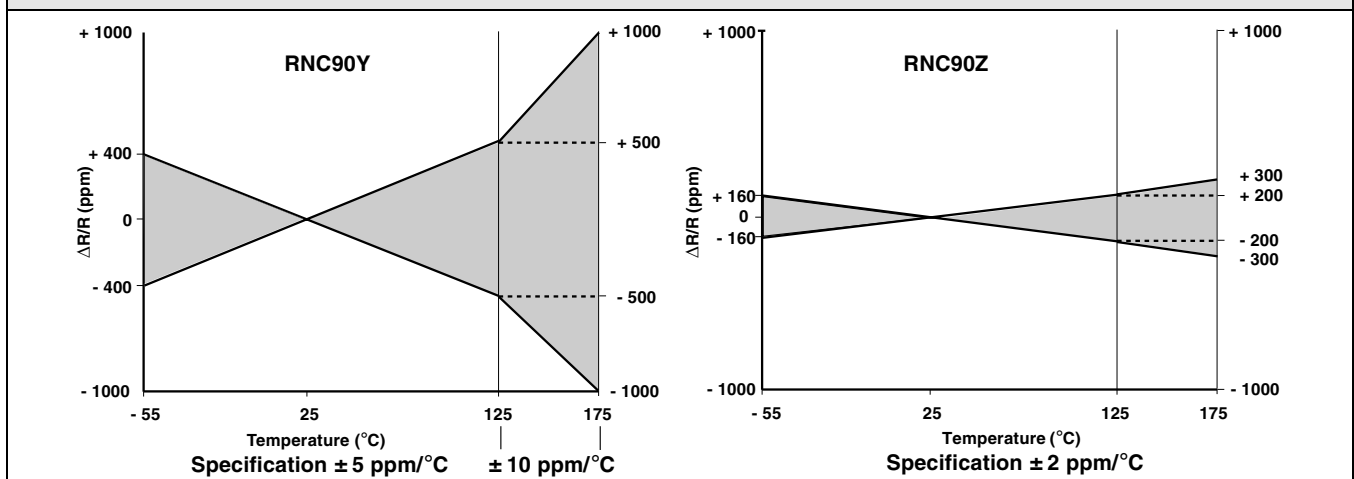

**TABLE 1 - SPECIFICATIONS COMPARISON**

SPECIFICATION	MIL-PRF-55182/9 CHARACTERISTIC Y LIMITS QUALIFIED RNC90Y	MIL-PRF-55182/9 CHARACTERISTIC Z LIMITS QUALIFIED RNC90Z
Temperature Coefficient of Resistance	$\pm 5 \text{ ppm}/^\circ\text{C}$ ( $-55^\circ\text{C}$ to $+125^\circ\text{C}$ ) $\pm 10 \text{ ppm}/^\circ\text{C}$ ( $+125^\circ\text{C}$ to $+175^\circ\text{C}$ )	$\pm 2 \text{ ppm}/^\circ\text{C}$ ( $-55^\circ\text{C}$ to $+175^\circ\text{C}$ ) $\pm 2 \text{ ppm}/^\circ\text{C}$ ( $+125^\circ\text{C}$ to $+175^\circ\text{C}$ )
Resistance Range	4.99 $\Omega$ to 121 k $\Omega$	30.1 $\Omega$ to 121 k $\Omega$
Failure Rate	Level R	Level R
Load-Life Stability 0.3 W at $+125^\circ\text{C}$ at 2000 h at 10 000 h	$\pm 0.05 \%$ maximum $\Delta R$ $\pm 0.5 \%$ maximum $\Delta R$	$\pm 0.05 \%$ maximum $\Delta R$ $\pm 0.5 \%$ maximum $\Delta R$
Voltage Coefficient	0.0005 %/V	0.0005 %/V
Working Voltage	300 V maximum	300 V maximum

**TABLE 2 - MODEL SELECTION**

MODEL NUMBER	RESISTANCE RANGE (Ω)	STANDARD RESISTANCE TOLERANCE		FAILURE RATE	AMBIENT POWER RATING		AVERAGE WEIGHT (g)
		TIGHTEST %	LOOSEST %		at + 70 °C	at + 125° C	
RNC90Z (RNC90S)	30.1 Ω to 121 kΩ	± 0.005	± 1.0	R	0.6 W	0.3 W	0.6

**FIGURE 2 - IMPRINTING AND DIMENSIONS**

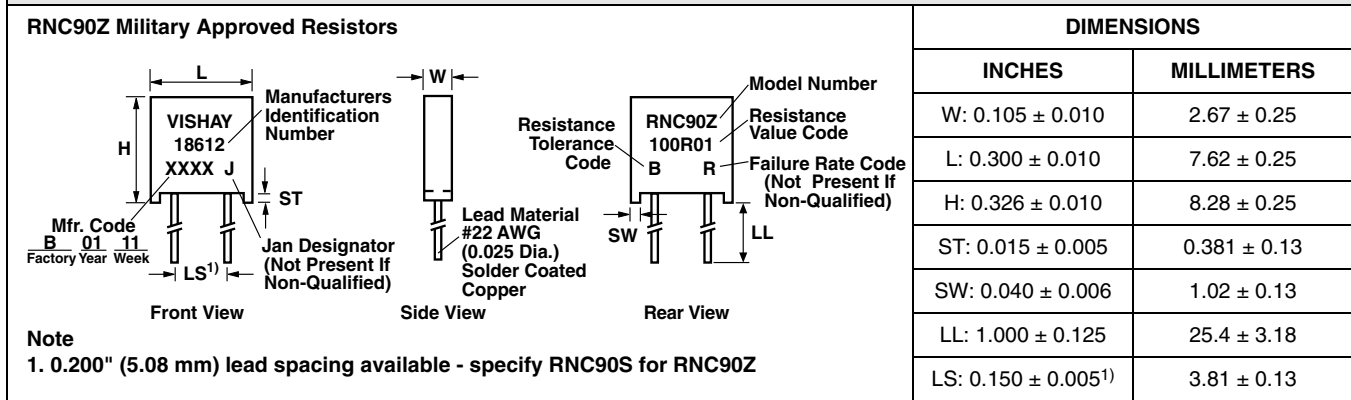

**FIGURE 3 - TRIMMING TO VALUES**  
(Conceptual Illustration)

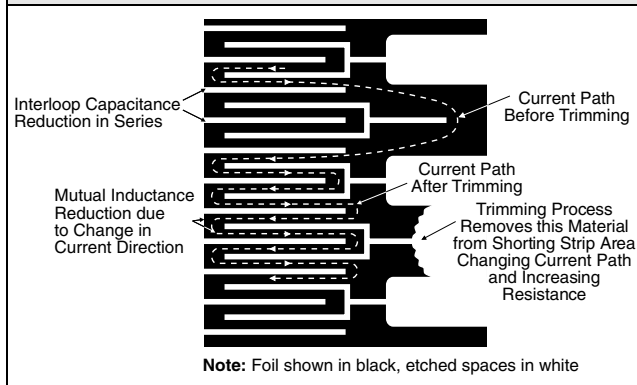

**FIGURE 4 - POWER DERATING CURVE**

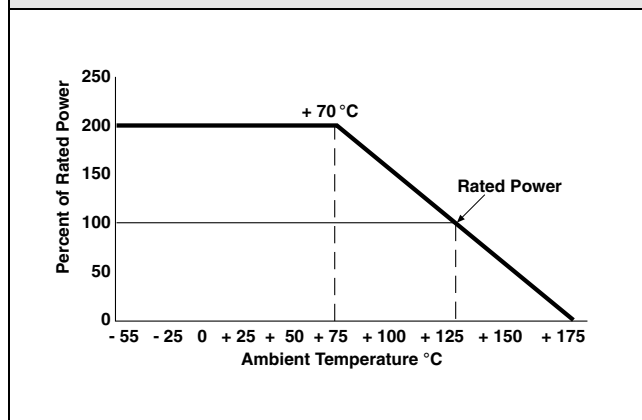

**TABLE 3 - RESISTANCE TOLERANCE**

TOLERANCE	SYMBOL
± 0.005 %	V
± 0.01 %	T
± 0.05 %	A
± 0.1 %	B
± 0.5 % <sup>1)</sup>	D
± 1.0 % <sup>1)</sup>	F

**Note**  
1. ± 0.5 % and ± 1.0 % resistors available only in standard values per MIL-PRF-55182

**TABLE 4 - FAILURE RATE LEVEL (FRL)**

FRL	SYMBOL
± 0.01 %	R
± 0.1 %	P
± 1.0 %	M



# Military and Space Established Reliability (ER)

Z-Bulk Metal<sup>®</sup> Foil Technology  
RNC90Z to MIL-PRF-55182/9

Vishay Foil Resistors

**TABLE 5 - GLOBAL PART NUMBER INFORMATION**

NEW GLOBAL PART NUMBER: Y1189100R500AR0L (preferred part number format)

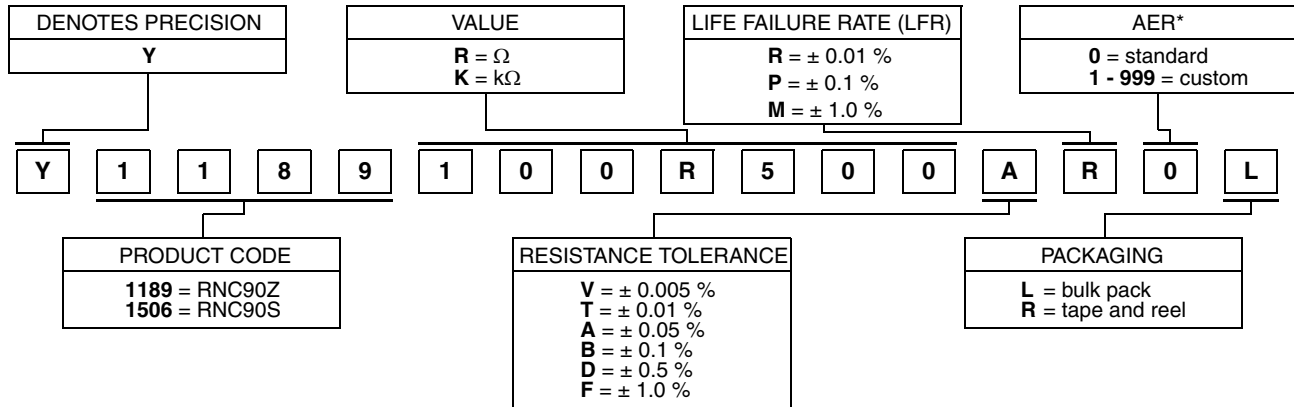

FOR EXAMPLE: ABOVE GLOBAL ORDER Y1189 100R500 A R 0 L:

TYPE: RNC90Z  
VALUE: 100.5  $\Omega$   
ABSOLUTE TOLERANCE:  $\pm 0.05\%$   
LIFE FAILURE RATE (LFR):  $\pm 0.01\%$   
AER: standard  
PACKAGING: bulk pack

HISTORICAL PART NUMBER: RNC90Z 100R50 A R B (will continue to be used)

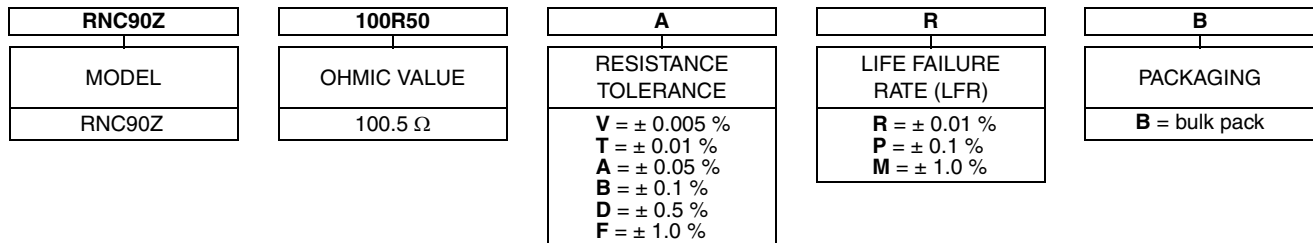

**Note**

\* For non-standard requests, please contact application engineering.

**CAGE #18612**

"Commercial and Government Entity"  
Formerly "FSCM"

# Military and Space Established Reliability (ER)



Vishay Foil Resistors

Z-Bulk Metal® Foil Technology  
RNC90Z to MIL-PRF-55182/9

The response of military and non military grade resistors to environmental stresses can be made better by “Improved Performance Testing” (IPT). The IPT part will see burn-in and cycling that removes the “knee” from the normal drift of non IPT parts. (See Table 6 for the improvement to expect in military parts when calling for Vishay recommended screening). Users should be aware that IPT testing renders the part non QPL and so a 3XXXXX part number will be assigned by Vishay. Consult Applications Engineering for details and ordering advice.

**TABLE 6 - IMPROVED PERFORMANCE TESTING (NON-QPL APPROVED) VS. QPL**

TEST GROUP	TEST	RNC90Z MIL-PRF-55182/9		VISHAY IMPROVED PERFORMANCE TESTING (IPT) LIMITS
		METHOD PARAGRAPH	LIMITS	
I	Power Conditioning	not done	-	± 0.0025 %
	Thermal Shock and	4.8.2	± 0.05 %	± 0.0025 %
	Overload Combined	4.8.3	± 0.05 %	± 0.0025 %
II	Resistance Temperature Characteristic	4.8.9	± 2 ppm/°C	< ± 2 ppm/°C (- 55 °C to + 125 °C) (Can be sorted for tighter tracking)
	Low Temperature Storage	4.8.23	± 0.05 %	± 0.0025 %
	Low Temperature Operation	4.8.10	± 0.05 %	± 0.0025 %
	Terminal Strength	4.8.11	± 0.02 %	± 0.001 %
III	DWV	4.8.12	± 0.02 %	± 0.001 %
	Insulation Resistance	4.8.13	10 <sup>4</sup> MΩ	> 10 <sup>4</sup> MΩ
	Resistance to Soldering Heat	4.8.14	± 0.02 %	± 0.001 %
	Moisture Resistance	4.8.15	± 0.05 %	± 0.015 %
IV	Shock	4.8.16	± 0.01 %	± 0.0025 %
	Vibration	4.8.17	± 0.02 %	± 0.0025 %
V	Load Life at + 125 °C; 2000 h	4.8.18	± 0.05 %	± 0.005 % (50 ppm)
	Load Life at + 125 °C; 10 000 h	4.8.18	± 0.5 %	± 0.015 % (150 ppm)
V (a)	+ 85 °C Power Rating	-	-	± 0.005 % (50 ppm)
	+ 70 °C Power Rating	4.8.18	± 0.05 %	± 0.005 % (50 ppm)
V (b)	+ 25 °C Power Rating	-	-	± 0.005 % (50 ppm)
VI	Storage Life	-	-	± 0.0025 %
VII	High Temperature Exposure	4.8.19	± 0.5 %	± 0.005 %
VIII	Max. Allowance Reactance	-	-	< 1 %
	Current Noise	-	-	< - 32 dB
	Voltage Coefficient	4.8.20	0.0005 %/V (5 ppm/V)	< 0.00001 %/V (< 0.1 ppm/V)
	Thermal EMF	-	-	0.1 μV/°C

**FIGURE 4 - IPT IMPRINTING AND DIMENSIONS** in inches (millimeters)

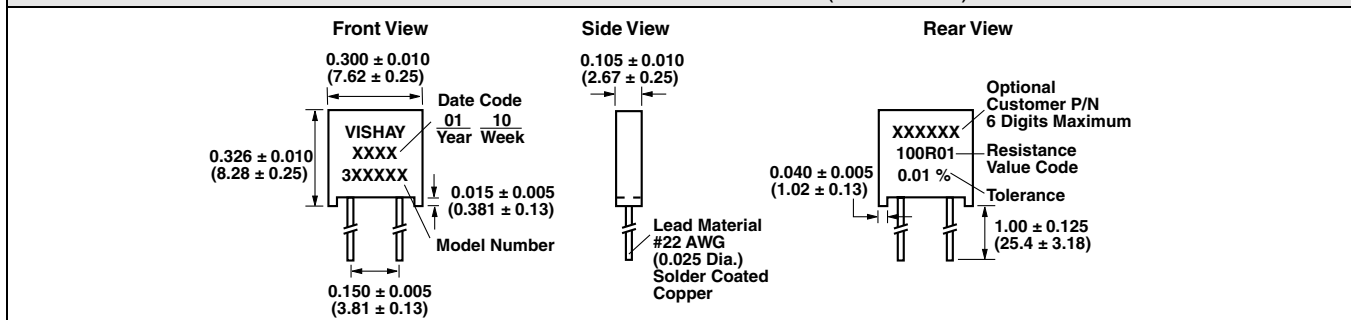



## Disclaimer

All product specifications and data are subject to change without notice.

Vishay Intertechnology, Inc., its affiliates, agents, and employees, and all persons acting on its or their behalf (collectively, "Vishay"), disclaim any and all liability for any errors, inaccuracies or incompleteness contained herein or in any other disclosure relating to any product.

Vishay disclaims any and all liability arising out of the use or application of any product described herein or of any information provided herein to the maximum extent permitted by law. The product specifications do not expand or otherwise modify Vishay's terms and conditions of purchase, including but not limited to the warranty expressed therein, which apply to these products.

No license, express or implied, by estoppel or otherwise, to any intellectual property rights is granted by this document or by any conduct of Vishay.

The products shown herein are not designed for use in medical, life-saving, or life-sustaining applications unless otherwise expressly indicated. Customers using or selling Vishay products not expressly indicated for use in such applications do so entirely at their own risk and agree to fully indemnify Vishay for any damages arising or resulting from such use or sale. Please contact authorized Vishay personnel to obtain written terms and conditions regarding products designed for such applications.

Product names and markings noted herein may be trademarks of their respective owners.