

SMFL Single and Dual DC/DC Converters

28 VOLT INPUT – 65 WATT

FEATURES

Parallel operation with current share, up to 3 units (148 watts)

- Operating temperature -55° to +125°C
- Qualified to MIL-PRF-38534 Class H and K
- Radiation hardness assurance (RHA) to level R 100 kRad(Si)
- Input voltage range 16 to 40 VDC
- Transient protection 50 V for 120 ms
- Fully isolated, magnetic feedback
- Fixed high frequency switching
- Remote sense and output trim on single output models
- Inhibit function
- Synchronization input and output
- Indefinite short circuit protection
- High power density, 85% efficiency



MODELS	
VDC OUTPUT	
SINGLE	DUAL
3.3	±5
5	±12
12	±15
15	

DESCRIPTION

The SMFL Series™ 28-volt DC/DC converters are rated up to 65 watts output power over a -55° to +125°C temperature range with a 28 VDC nominal input. On dual output models up to 70% of the rated output power can be drawn from either the positive or negative outputs. Current sharing allows the units to be paralleled for total power of up to 148 watts. The welded, hermetically sealed package is only 3.0 x 1.5 x 0.40 inches, giving the series an overall power density of up to 43 watts per cubic inch.

SCREENING

SMFL converters, also available on SMD drawings, offer the following screening options: Space Prototype (O), Class H, or Class K. Radiation tolerant to Radiation Hardness Assurance (RHA) levels of “-” (O), “P,” or “R,” per MIL-PRF-38534. Interpoint model numbers use an “O” in the RHA designator position to indicate the “-” (dash) Radiation Hardness Assurance level of MIL-PRF-38534, which is defined as “no RHA”. See Screening Tables 1 - 3 for more information.

DESIGN FEATURES

SMFL Series converters are switching regulators that use a quasi-square wave, single ended forward converter design with a constant switching frequency of 600 kHz typical.

Isolation between input and output circuits is provided with a transformer in the forward path and a wide bandwidth magnetic coupling in the feedback control loop. The SMFL uses a unique dual loop feedback technique that controls output current with an inner feedback loop and an output voltage with a cascaded voltage mode feedback loop. The additional secondary current mode feedback loop improves transient response in a manner

similar to primary current mode control and allows for ease of paralleling, but without the cost and complexity.

The constant frequency, pulse-width modulated converters use a quasi-square wave single-ended forward design. Tight load regulation is achieved through a wide-bandwidth magnetic feedback circuit. The output voltage on single SMFL models can be trimmed to a specific output voltage by adding an external resistor (see Figure 1 for resistor values).

INHIBIT

The SMFL Series converters have two inhibit terminals (INH1 and INH2) that can be used to disable power conversion, resulting in a very low quiescent input current and no generation of switching noise. An active low (<0.8 volts) is required to inhibit the converter between INH1 (pin 4) and Input Common (pin 2). An active low (<0.5 volts) is required to inhibit the converter between INH2 (pin 12) and Output Common (pin 8). The application of intermediate voltages to these pins (1.5 to 10.5 volts) should be avoided.

SYNC

Converters may be synced to an external clock (525 to 675 kHz) or to one another by using the sync in or out pins. The nominal free-run switching frequency is 600 kHz (see Application Note titled “Inhibit and Synchronization”).

CURRENT AND PARALLEL OPERATION

Multiple single output SMFL converters may be used in parallel to drive a common load. In this mode of operation the load current is shared by two or three SMFL converters. In current

SMFL Single and Dual DC/DC Converters

28 VOLT INPUT – 65 WATT

sharing mode, one SMFL converter is designated as a master. The SLAVE pin (pin 11) of the master is left unconnected and the MSTR/INH2 pin (pin 12) of the master is connected to the SLAVE pin (pin 11) of the slave units. The units designated as slaves have the MSTR/INH2 pin (pin 12) connected to the SNS RTN pin (pin 9). Note that synchronizing the units together is not required for current sharing operation.

A second slave unit may be placed in parallel with a master and slave; this requires the TRI pin (pin 3) of the master unit to be connected to the SNS RTN pin (pin 9). See Figure 2 for a block diagram of parallel connections.

When paralleled, 76% of the total combined power ratings of the SMFL converters are available at the load. Overload and short circuit performance are not adversely affected during parallel operation.

OPERATING CONDITIONS AND CHARACTERISTICS

Input Voltage Range

- 16 to 40 VDC continuous
- 50 V for 120 ms transient

Output Power

- 40 to 65 watts depending on model

Lead Soldering Temperature (10 sec per lead)

- 300°C

Storage Temperature Range (Case)

- -65°C to +150°C

Power Dissipation (Pd)

- 14 watts (16 watts SMFL2805S, SMFL2805D)

Case Operating Temperature (Tc)

- -55°C to +125°C full power

Derating Output Power/Current

- Linearly from 100% at 125°C to 0% at 135°C
- MFL283R3S: linearly from 100% at 100°C to 85% at 125°C to 0% at 135°C

Output Voltage Temperature Coefficient

- 100 ppm/°C typical

Input to Output Capacitance

- 150 pF, typical

Current Limit

- 125% of full load typical

Isolation

- 100 megohm minimum at 500 V

Audio Rejection

- 50 dB typical

Conversion Frequency (-55°C to 125°C)

- Free run mode 600 kHz typical
- 525 kHz. min, 675 kHz max

SYNC AND INHIBIT (INH1, INH2)

Sync

- Sync In
 - Input frequency 525 to 675 Hz.
 - Duty cycle 40% min, 60% max
 - Logic low 0.8 V max
 - Logic high 4.5 V min, 5 V max
 - Referenced to input common
- Sync Out
 - Referenced to input common

Inhibit (INH1, INH2)

- Active low (output disabled)
 - INH1 referenced to input common
 - Active low 0.8 V max
 - Inhibit pin current 10 mA max
 - INH2 referenced to output common
 - Active low 0.5 V max
 - Inhibit pin current 5 mA max
- Active high (output enabled)
 - Open collector (output enabled)
 - Avoid intermediate voltages of 1.5 to 10.5
 - Open pin voltage
 - INH1 = 9 to 12 V
 - INH2 = 9 V max

MECHANICAL AND ENVIRONMENTAL

Size (maximum)

- 3.005 x 1.505 x 0.400 inches (76.33 x 38.23 x 10.16 mm)
See case U for dimensions.
- Case option V is also available.

Weight (maximum)

- 86 grams

Screening

Space Prototype (O), Class H, or Class K are radiation tolerant to Radiation Hardness Assurance (RHA) levels of “-” (O), “P,” or “R,” per MIL-STD-38534. Interpoint model numbers use an “O” in the RHA designator position to indicate the “-” (dash) Radiation Hardness Assurance level of MIL-PRF-38534, which is defined as “no RHA”.

See Screening Tables 1 - 3 for more information. Available configurations: OO, HP, KP, HR, KR

SMFL Single and Dual DC/DC Converters

28 VOLT INPUT – 65 WATT

SINGLE OUTPUT MODELS CONNECTION DIAGRAMS - TRIM, SENSE AND PARALLEL

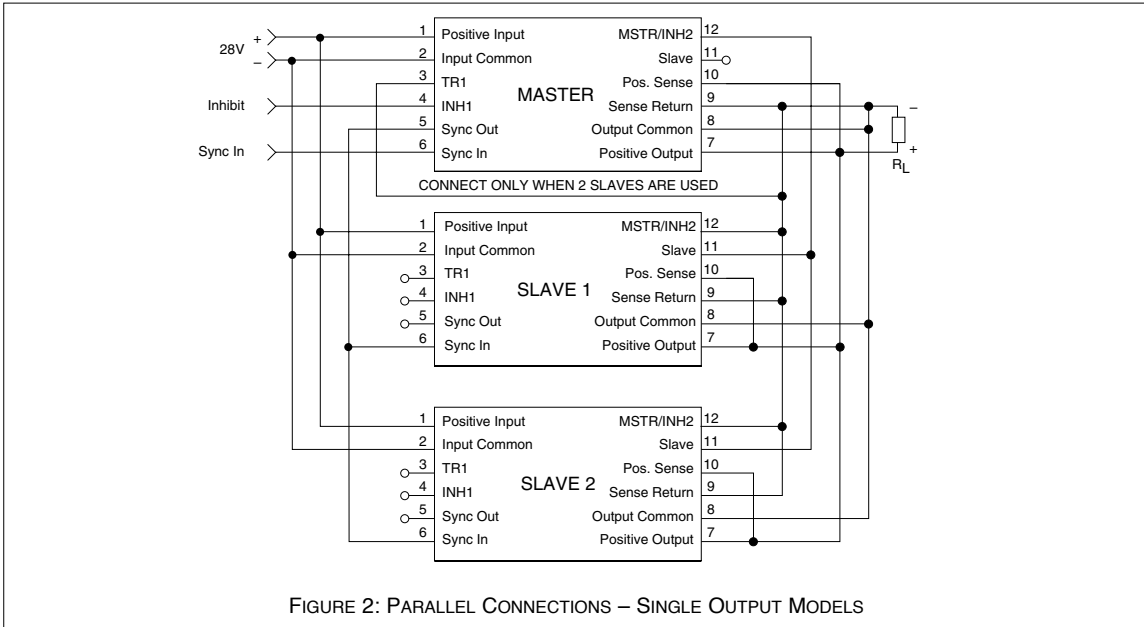
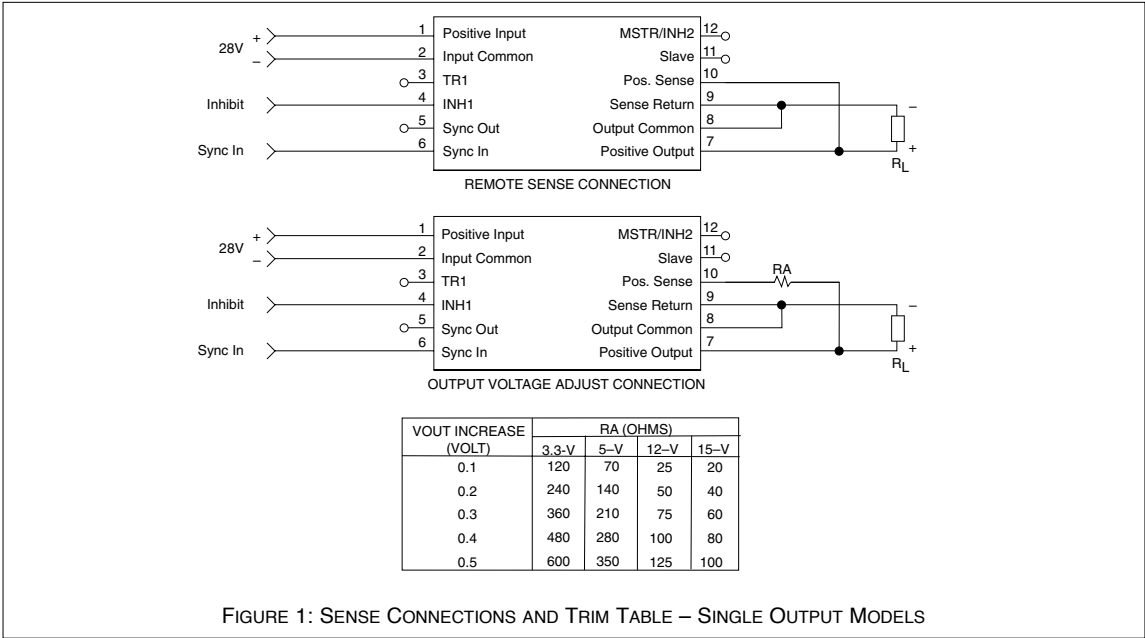

SMFL Single and Dual DC/DC Converters

28 VOLT INPUT – 65 WATT

PIN OUT		
Pin	Single Output	Dual Output
1	Positive Input	Positive Input
2	Input Common	Input Common
3	Triple (TR1)	Triple (TR1)
4	Inhibit 1 (INH1)	Inhibit 1 (INH1)
5	Sync Out	Sync Out
6	Sync In	Sync In
7	Positive Output	Positive Output
8	Output Common	Output Common
9	Sense Return	Negative Output
10	Positive Sense	No connection
11	Slave	Slave
12	Master/Inhibit 2	Master/Inhibit 2

PINS NOT IN USE		
Pin	Description	Action
3	TR1	Leave unconnected
4	Inhibit 1 (INH1)	Leave unconnected
5	Sync Out	Leave unconnected
6	Sync In	Connect to Input Common
9	Sense Return	Connect to appropriate outputs
10	Positive Sense	Connect to appropriate outputs
11	Slave	Leave unconnected
12	Master/Inhibit 2	Leave unconnected

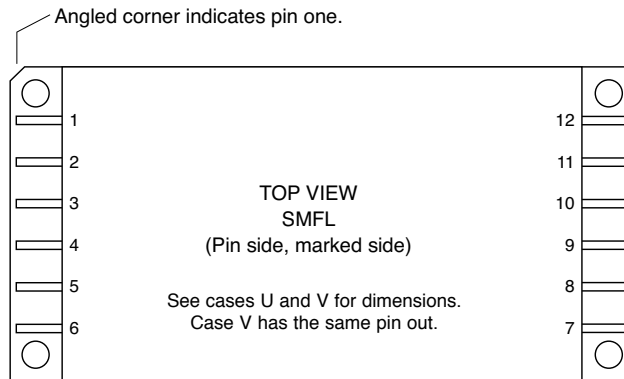
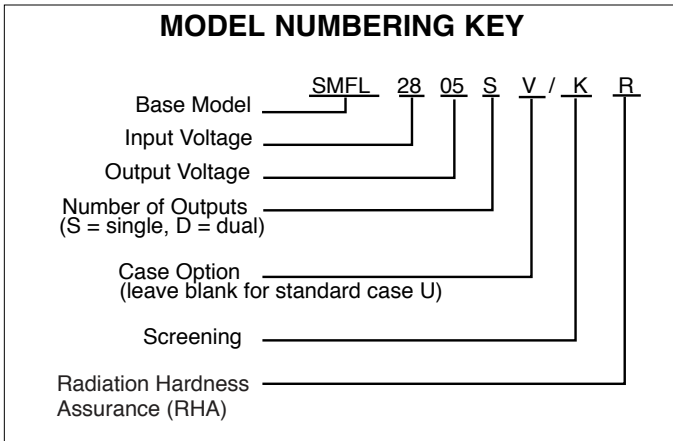

FIGURE 3: PIN OUT

SMFL Single and Dual DC/DC Converters

28 VOLT INPUT – 65 WATT



SMD NUMBERS

STANDARD MICROCIRCUIT DRAWING (SMD)	SMFL SERIES SIMILAR PART
5962R0621302KXC	SMFL283R3S/KR
5962R9316302KXC	SMFL2805S/KR
5962R9316202KXC	SMFL2812S/KR
5962R9316102KXC	SMFL2815S/KR
5962R9319102KXC	SMFL2805D/KR
5962R9319302KXC	SMFL2812D/KR
5962R9319202KXC	SMFL2815D/KR

The SMD number shown is for Class H screening, non-flanged, and no Radiation Hardness Assurance (RHA) level. See the SMD for the numbers for other screening and RHA levels. For exact specifications for an SMD product, refer to the SMD drawing. SMDs can be down-loaded from: <http://www.dscc.dla.mil/programs/smcr>

MODEL SELECTION							
ON THE LINES BELOW, ENTER ONE SELECTION FROM EACH CATEGORY TO DETERMINE THE MODEL NUMBER.							
CATEGORY	SMFL28 Base Model and Input Voltage	Output Voltage ¹	Number of Outputs ²	Case/Lead Options ³	/	Screening ⁴	RHA ⁵
SELECTION	SMFL28 is the only available option	3R3, 05, 12, 15	S	(U, leave blank)		O	O
		05, 12, 15	D	V		H K	P R

Notes:

1. Output Voltage: An R indicates a decimal point. 3R3 is 3.3 volts out.
2. Number of Outputs: S is a single output and D is a dual output
3. Case Options: For the standard case (case U) leave the case option blank. For case option V, insert the letter V in the case option position.
4. Screening: A screening level of O is a Space Prototype and is only used with RHA O. See Screening Tables 1, 2 and 3 for more information.
5. RHA: Interpoint model numbers use an "O" in the RHA designator position to indicate the "-" (dash) Radiation Hardness Assurance level of MIL-PRF-38534, which is defined as "no RHA." RHA O is only available with Screening level O. See Screening Table 3 for more information.

SMFL Single and Dual DC/DC Converters

28 VOLT INPUT – 65 WATT

Electrical Characteristics: -55°C to +125°C T_c, 28 VDC V_{in}, 100% load, RHA level O, unless otherwise specified.

SINGLE OUTPUT MODELS		SMFL283R3S			SMFL2805S			UNITS
PARAMETER	CONDITIONS	MIN	TYP	MAX	MIN	TYP	MAX	
OUTPUT VOLTAGE		3.21	3.30	3.39	4.87	5.00	5.13	VDC
OUTPUT CURRENT	V _{IN} = 16 TO 40 VDC	0	—	12.12	0	—	10	A
OUTPUT POWER	V _{IN} = 16 TO 40 VDC	0	—	40	0	—	50	W
OUTPUT RIPPLE 10 kHz - 2 MHz	T _C = 25°C	—	10	35	—	15	35	mV p-p
	T _C = -55°C TO +125°C	—	10	50	—	30	50	
LINE REGULATION	V _{IN} = 16 TO 40 VDC	—	0	20	—	0	20	mV
LOAD REGULATION	NO LOAD TO FULL	—	—	40	—	—	20	mV
INPUT VOLTAGE	CONTINUOUS	16	28	40	16	28	40	VDC
	TRANSIENT ^{1,2}	—	—	50	—	—	50	V
INPUT CURRENT	NO LOAD	—	70	100	—	70	120	mA
	INHIBITED – INH1	—	9	14	—	9	14	
	INHIBITED – INH2	—	35	70	—	35	70	
INPUT RIPPLE	10 kHz - 10 MHz	—	30	50	—	30	50	mA p-p
EFFICIENCY	T _C = 25°C	71	—	—	75	78	—	%
	T _C = -55°C TO +125°C	69	—	—	73	—	—	
LOAD FAULT	SHORT CIRCUIT POWER DISSIPATION	—	12.5	16	—	12.5	18	W
	RECOVERY ¹		1.5	6		1.5	4	ms
STEP LOAD RESPONSE	50% - 100% - 50% TRANSIENT	—	±200	±300	—	±250	±350	mV pk
	RECOVERY ^{1,3}	—	1.5	3.0	—	1.5	3.0	ms
STEP LINE RESPONSE ^{1,3}	16 - 40 - 16 VDC TRANSIENT ⁴	—	±250	±300	—	±250	±300	mV pk
	RECOVERY	—	200	300	—	200	300	μs
START-UP ⁵	DELAY	—	3.5	10	—	3.5	6	ms
CAPACITIVE LOAD ⁶	T _C = 25°C	—	—	1000	—	—	1000	μF

Notes

1. **Guaranteed by design, not tested.**

2. Unit will shut down above approximately 45 V but will be undamaged and will restart when voltage drops into normal range.

3. Recovery time is measured from application of the transient to point at which V_{OUT} is within 1% of final value.

4. Transition time 100 μs ±20%.

5. Tested on release from inhibit.

6. Shall not compromise DC performance.

SMFL Single and Dual DC/DC Converters

28 VOLT INPUT – 65 WATT

SINGLE OUTPUT MODELS		SMFL2812S			SMFL2815S			UNITS
PARAMETER	CONDITIONS	MIN	TYP	MAX	MIN	TYP	MAX	
OUTPUT VOLTAGE		11.76	12.00	12.24	14.55	15.00	15.45	VDC
OUTPUT CURRENT	V _{IN} = 16 TO 40 VDC	0	—	5	0	—	4.33	A
OUTPUT POWER	V _{IN} = 16 TO 40 VDC	0	—	60	0	—	65	W
OUTPUT RIPPLE 10 kHz - 2 MHz	T _C = 25°C	—	0	75	—	30	85	mV p-p
	T _C = -55°C TO +125°C	—	45	100	—	45	110	
LINE REGULATION	V _{IN} = 16 TO 40 VDC	—	0	20	—	0	20	mV
LOAD REGULATION	NO LOAD TO FULL	—	—	40	—	—	20	mV
INPUT VOLTAGE	CONTINUOUS	16	28	40	16	28	40	VDC
	TRANSIENT 120 ms ^{1,2}	—	—	50	—	—	50	V
INPUT CURRENT	NO LOAD	—	50	100	—	50	100	mA
	INHIBITED – INH1	—	9	14	—	9	14	
	INHIBITED – INH2	—	35	70	—	35	70	
INPUT RIPPLE	10 kHz - 10 MHz	—	30	50	—	30	50	mA p-p
EFFICIENCY	T _C = 25°C	81	84	—	82	85	—	%
	T _C = -55°C TO +125°C	79	—	—	80	—	—	
LOAD FAULT	SHORT CIRCUIT POWER DISSIPATION	—	10	16	—	10	16	W
	RECOVERY ¹		1.5	4		1.5	4	ms
STEP LOAD RESPONSE	50% - 100% - 50% TRANSIENT	—	±450	±600	—	±500	±600	mV pk
	RECOVERY ^{1, 3}	—	1.5	3.0	—	1.5	3.0	ms
STEP LINE RESPONSE ^{1, 3}	16 - 40 - 16 VDC TRANSIENT ⁴	—	±250	±400	—	±250	±500	mV pk
	RECOVERY	—	200	300	—	200	300	μs
START-UP ⁵	DELAY	—	3.5	6	—	3.5	6	ms
CAPACITIVE LOAD ⁶	T _C = 25°C	—	—	1000	—	—	1000	μF

Notes

1. **Guaranteed by design, not tested.**

2. Unit will shut down above approximately 45 V but will be undamaged and will restart when voltage drops into normal range.

3. Recovery time is measured from application of the transient to point at which V_{OUT} is within 1% of final value.

4. Transition time 100 μs ±20%.

5. Tested on release from inhibit.

6. Shall not compromise DC performance.

SMFL Single and Dual DC/DC Converters

28 VOLT INPUT – 65 WATT

Electrical Characteristics: -55°C to +125°C T_c, 28 VDC V_{in}, 100% load, RHA level O, unless otherwise specified.

DUAL OUTPUT MODELS ²		SMFL2805D			SMFL2812D			SMFL2815D			UNITS
PARAMETER	CONDITIONS	MIN	TYP	MAX	MIN	TYP	MAX	MIN	TYP	MAX	
OUTPUT VOLTAGE V _{IN} 16 TO 40 VDC	+V _{OUT}	4.85	5.00	5.15	11.64	12.00	12.36	14.55	15.00	15.45	VDC
	-V _{OUT}	4.82	5.00	5.18	11.58	12.00	12.42	14.47	15.00	15.53	
OUTPUT CURRENT ^{2, 3} V _{IN} 16 TO 40 VDC	EACH OUTPUT	0	—	7	0	—	3.5	0	—	3.03	A
	TOTAL	0	—	10	0	—	5	0	—	4.33	
OUTPUT POWER ²	V _{in} = 16 to 40 VDC	0	—	50	0	—	60	0	—	65	W
OUTPUT RIPPLE	10 kHz - 2 MHz ± V _{OUT}	—	50	100	—	50	120	—	50	150	mV p-p
LINE REGULATION V _{IN} 16 TO 40 VDC	+V _{OUT}	—	0	50	—	0	50	—	0	50	mV
	-V _{OUT}	—	25	100	—	25	100	—	25	100	
LOAD REGULATION NO LOAD TO FULL	+V _{OUT}	—	0	50	—	0	50	—	0	50	mV
	-V _{OUT}	—	25	100	—	50	120	—	150	150	
CROSS REGULATION T _C = 25°C	SEE NOTE 4	—	5	8	—	2	4	—	2	4	%
	SEE NOTE 5	—	3	6	—	2	4	—	2	4	
INPUT VOLTAGE	+V _{OUT}	16	28	40	16	28	40	16	28	40	VDC
	TRANSIENT 120 ms ^{1, 6}	—	—	50	—	—	50	—	—	50	v
INPUT CURRENT	NO LOAD	—	50	120	—	50	100	—	50	100	mA
	INHIBITED-INH1	—	9	14	—	9	14	—	9	14	
	INHIBITED-INH2	—	35	70	—	35	70	—	35	70	
INPUT RIPPLE CURRENT	10 kHz - 10 MHz	—	30	50	—	30	50	—	30	80	mA p-p
EFFICIENCY BALANCED LOAD	T _C = 25°C	75	78	—	81	84	—	82	85	—	%
	T _C = -55°C TO +125°C	73	—	—	79	—	—	80	—	—	
LOAD FAULT	SHORT CIRCUIT POWER DISSIPATION	—	12.5	18	—	10	16	—	10	16	W
	RECOVERY ¹	—	1.5	4.0	—	1.5	4.0	—	1.5	4.0	ms
STEP LOAD RESPONSE ⁷ ± V _{OUT}	50% - 100% - 50% TRANSIENT	—	±250	±350	—	±450	±600	—	±500	±600	mV pk
	RECOVERY ^{1, 8}	—	1.5	3.0	3.0	1.5	3.0	—	1.5	3.0	ms
STEP LINE RESPONSE ^{1, 7} ± V _{OUT}	16 - 40 - 16 VDC TRANSIENT	—	±250	±300	—	±250	±400	—	±250	±500	mV pk
	RECOVERY ⁸	—	200	300	—	200	300	—	200	300	μs
START-UP ⁹	DELAY	—	3.5	6	—	3.5	6	—	3.5	6	ms
CAPACITIVE LOAD ¹⁰	T _C = 25°C	—	—	500	—	—	500	—	—	500	μF

Notes

1. Guaranteed by design, not tested.

2. Parallel load share function is not characterized for dual output models.

3. Up to 70% of the total output power is available from either output providing the opposite output is simultaneously carrying 30% of the total power.

4. Effect on negative V_{out} from 50%/50% loads to 70%/30% or 30%/70% loads.

5. Effect on negative V_{out} from 50%/50% loads to 50% then 10% load on negative V_{out}.

6. Unit will shut down above approximately 45V but will be undamaged and will restart when voltage drops into normal range.

7. Transition time 100 μs ±20%.

8. Recovery time is measured from application of the transient to point at which V_{out} is within 1% of final value.

9. Tested on release from inhibit.

10. Shall not compromise DC performance.

SMFL Single and Dual DC/DC Converters

28 VOLT INPUT – 65 WATT

Typical Performance Curves: 25°C Tc, 28 VDC Vin, 100% load, free run, unless otherwise specified.

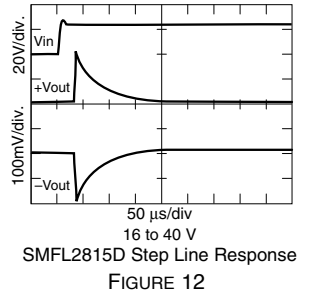
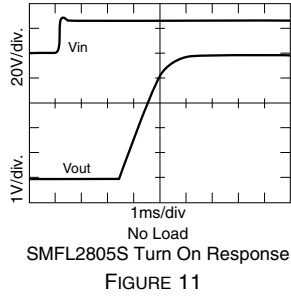
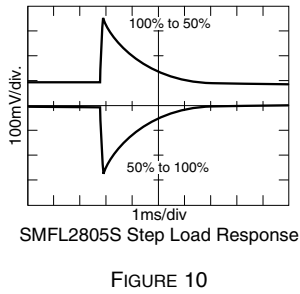
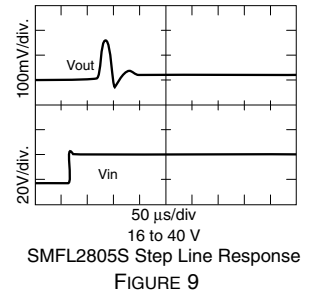
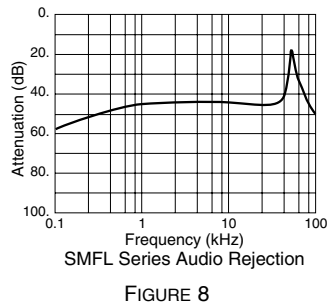
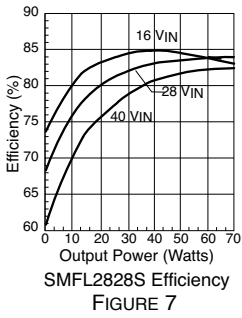
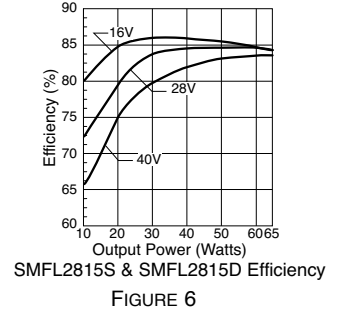
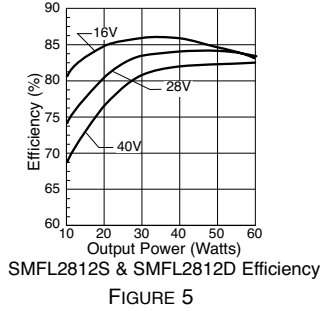
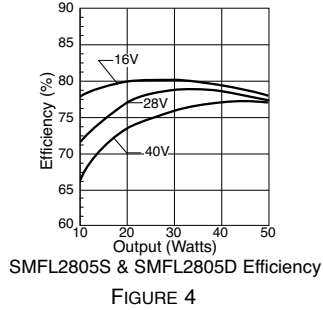

SMFL Single and Dual DC/DC Converters

28 VOLT INPUT – 65 WATT

Typical Performance Curves: 25°C Tc, 28 VDC Vin, 100% load, free run, unless otherwise specified.

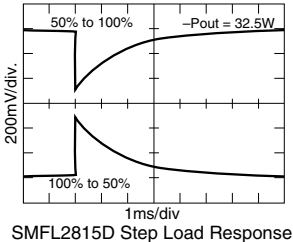

FIGURE 13

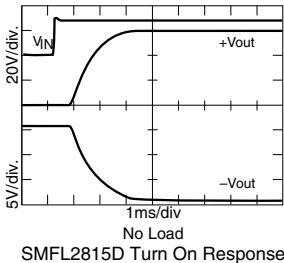

FIGURE 14

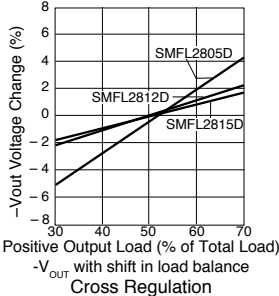

FIGURE 15

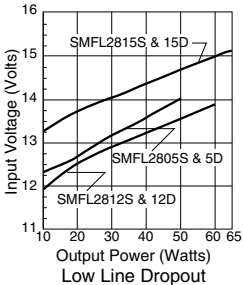

FIGURE 16

SMFL Single and Dual DC/DC Converter Cases

28 VOLT INPUT – 65 WATT

TOP VIEW CASE U* Flanged case, short-leaded

*Does not require designator in Case Option position of model number.

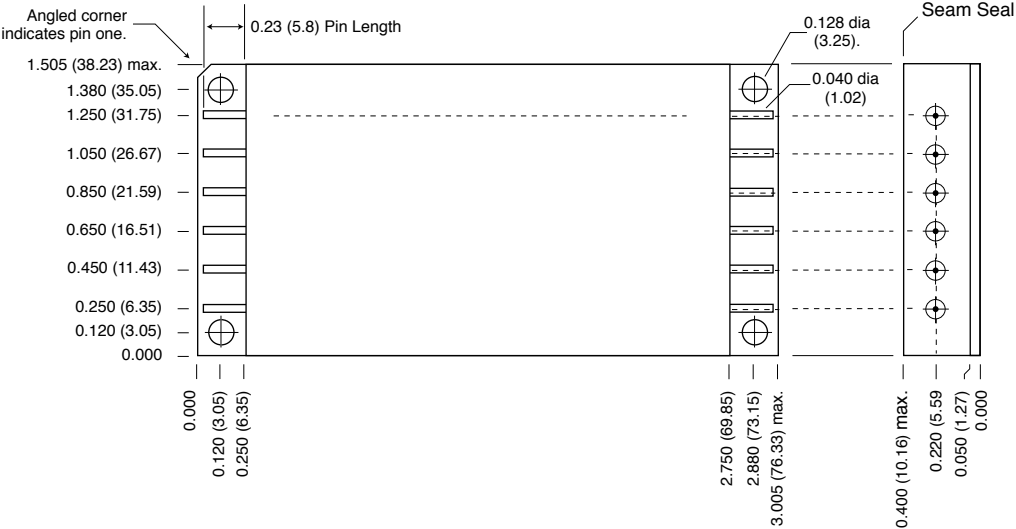

Case dimensions in inches (mm)
 Tolerance ± 0.005 (0.13) for three decimal places
 ± 0.01 (0.3) for two decimal places
 unless otherwise specified

CAUTION
 Heat from reflow or wave soldering may damage the device. Solder pins individually with heat application not exceeding 300°C for 10 seconds per pin.

Materials
 Header Cold Rolled Steel/Nickel/Gold
 Cover Kovar/Nickel
 Pins #52 alloy/Gold, compression glass seal
 Seal Hole: 0.100 \pm 0.002 (2.54 \pm 0.05)

Case U, Rev F, 20100503

FIGURE 17: CASE U

SMFL Single and Dual DC/DC Converter Cases

28 VOLT INPUT – 65 WATT

TOP VIEW CASE V* Flanged case, down leaded

*Designator "V" required in Case Option position of model number.

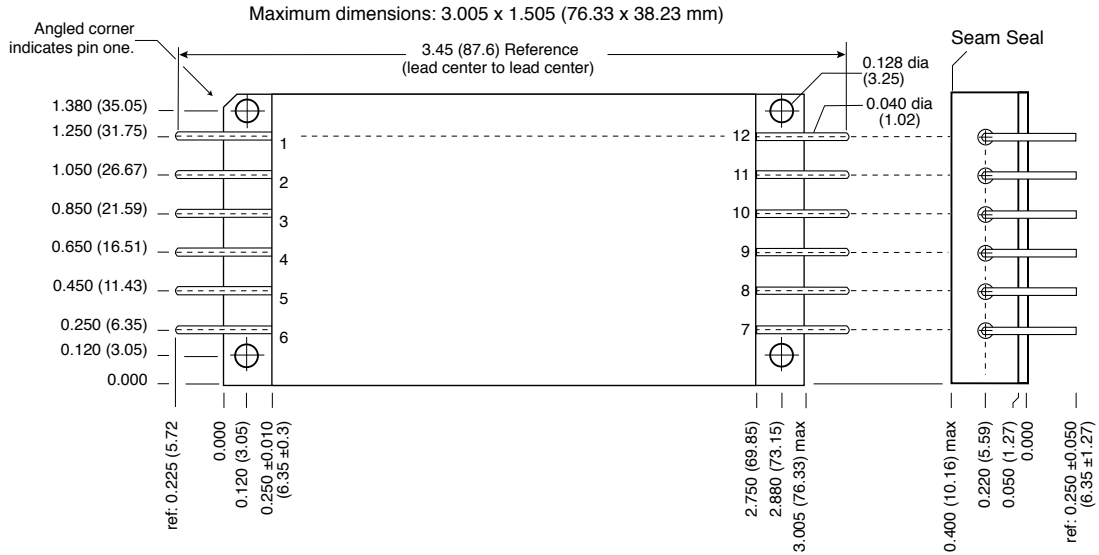

Case dimensions in inches (mm)

Tolerance ± 0.005 (0.13) for three decimal places
 ± 0.01 (0.3) for two decimal places
 unless otherwise specified

CAUTION

Heat from reflow or wave soldering may damage the device. Solder pins individually with heat application not exceeding 300°C for 10 seconds per pin.

Materials

Header Cold Rolled Steel/Nickel/Gold
 Cover Kovar/Nickel
 Pins #52 alloy/Gold, compression glass seal
 Seal Hole: 0.120 \pm 0.002 (3.05 \pm 0.05)

Case V, Rev F, 2010624
 Please refer to the numerical dimensions for accuracy.

FIGURE 18: CASE V

SMFL Single and Dual DC/DC Converters

28 VOLT INPUT – 65 WATT

CLASS H AND K, MIL-PRF-38534 ELEMENT EVALUATION

COMPONENT-LEVEL TEST PERFORMED	SPACE PROTOTYPE (O) NON-QML ¹		CLASS H QML		CLASS K QML	
	M/S ²	P ³	M/S ²	P ³	M/S ²	P ³
Element Electrical	yes	no	yes	yes	yes	yes
Element Visual	no	no	yes	yes	yes	yes
Internal Visual	no	N/A	yes	N/A	yes	N/A
Temperature Cycling	no	no	no	no	yes	yes
Constant Acceleration	no	no	no	no	yes	yes
Interim Electrical	no	N/A	no	N/A	yes	N/A
Burn-in	no	N/A	no	N/A	yes	N/A
Post Burn-in Electrical	no	N/A	no	N/A	yes	N/A
Steady State Life	no	N/A	no	N/A	yes	N/A
Voltage Conditioning Aging	N/A	no	N/A	no	N/A	yes
Visual Inspection	no	no	N/A	no	N/A	yes
Final Electrical	no	no	yes	yes	yes	yes
Wire Bond Evaluation	no	no	yes	yes	yes	yes
SEM	no	N/A	no	N/A	yes	N/A
SLAM™/C-SAM: Input capacitors only (Add'l test, not req. by H or K)	no	no	no	yes	no	yes

Notes:

1. Non-QML products do not meet all of the requirements of MIL-PRF-38534.
2. M/S = Active components (Microcircuit and Semiconductor Die)
3. P = Passive components

Definitions:

Element Evaluation: Component testing/screening per MIL-STD-883 as determined by MIL-PRF-38534
SEM: Scanning Electron Microscopy
SLAM™: Scanning Laser Acoustic Microscopy
C-SAM: C - Mode Scanning Acoustic Microscopy

SCREENING TABLE 1: ELEMENT EVALUATION

SMFL Single and Dual DC/DC Converters

28 VOLT INPUT – 65 WATT

CLASS H AND K, MIL-PRF-38534 ENVIRONMENTAL SCREENING

END ITEM-LEVEL TEST PERFORMED	SPACE PROTOTYPE (O) NON-QML ¹	CLASS H QML	CLASS K QML
Non-destruct bond pull Method 2023	no	yes ²	yes
Pre-cap Inspection Method 2017, 2032	yes	yes	yes
Temperature Cycle (10 times) Method 1010, Cond. C, -65°C to 150°C, ambient	yes	yes	yes
Constant Acceleration Method 2001, 3000 g	yes	yes	yes
PIND Test Method 2020, Cond. A	no	yes ²	yes
Pre burn-in test	yes	yes	yes
Burn-in Method 1015, 125°C case, typical			
96 hours	yes	no	no
160 hours	no	yes	no
2 x 160 hours (includes mid-BI test)	no	no	yes
Final Electrical Test MIL-PRF-38534 Group A, Subgroups 1 through 6 -55°C, +25°C, +125°C case	yes	yes	yes
Radiography Method 2012	N/A	N/A	yes
Post Radiography Electrical Test Room temperature	N/A	N/A	yes ²
Hermeticity Test Fine Leak, Method 1014, Cond. A Gross Leak, Method 1014, Cond. C	yes yes	yes yes	yes yes
Final visual inspection Method 2009	yes	yes	yes

Test methods are referenced to MIL-STD-883 as determined by MIL-PRF-38534.

Notes:

1. Space Prototype (O), non-QML products, do not meet all of the requirements of MIL-PRF-38534.
2. Not required by DSCC but performed to assure product quality.

SCREENING TABLE 2: ENVIRONMENTAL SCREENING

SMFL Single and Dual DC/DC Converters

28 VOLT INPUT – 65 WATT

CLASS H AND K, MIL-PRF-38534 RADIATION HARDNESS ASSURANCE (RHA)

RADIATION HARDNESS ASSURANCE LEVELS ¹	ENVIRONMENTAL SCREENING LEVELS		
	SPACE PROTOTYPE (O) NON-QML ²	CLASS H QML	CLASS K QML
O ³ Standard, no radiation guarantee	OO	N/A	N/A
P Radiation tolerant– Tested lots up to 30 kRad(Si) total dose. SEU ⁴ guarantee up to 40 MeV-cm ² /mg	N/A	HP	KP
R Radiation tolerant– Tested lots up to 100 kRad(Si) total dose. SEU ⁴ guarantee up to 40 MeV-cm ² /mg	N/A	HR	KR

Notes:

1. Redmond site, Interpoint, has a DSCC approved Radiation Hardness Assurance plan. Our SMD products with RHA "P" or "R" code meet DSCC requirements.
2. Space Prototype (O), non-QML, products do not meet all of the requirements of MIL-PRF-38534.
3. Interpoint model numbers use an "O" in the RHA designator position to indicate the "-" (dash) Radiation Hardness Assurance level of MIL-PRF-38534, which is defined as "no RHA".
4. No upset at the pins.

SCREENING TABLE 3: RADIATION HARDNESS ASSURANCE