

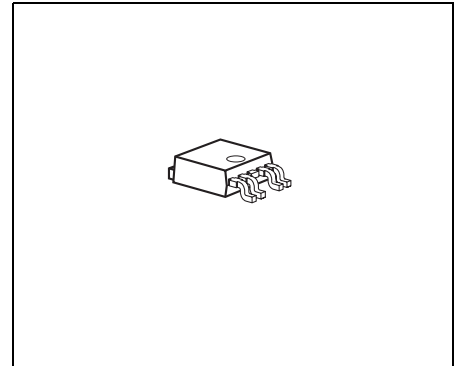

## Features

- Output 1: 350 mA; 3.3 V  $\pm$  4%
- Output 2: 430 mA; 5.0 V  $\pm$  4%
- Enable input for output 2
- Low quiescent current in OFF state
- Wide operation range: up to 42 V
- Reverse battery protection: up to 42 V
- Output protected against short circuit
- Wide temperature range: -40 °C to 170 °C
- Overvoltage protection up to 65 V (< 400 ms)
- Overtemperature protection
- Overload protection
- Green Product (RoHS compliant)
- AEC Qualified



## Functional Description

The TLE 4476 is a monolithic integrated voltage regulator providing two output voltages, Q1 is a 3.3 V output for loads up to 350 mA and Q2 is a 5 V output providing 430 mA. The device is available in the PG-TO252-5-11 (D-Pak) package. Output 2 can be switched ON/OFF via the Enable input EN.

The TLE 4476 is designed to supply microprocessor systems under the severe conditions of automotive applications and is therefore equipped with additional protection functions against overload, short circuit and overtemperature.

Type	Package
TLE 4476 D	PG-TO252-5-11

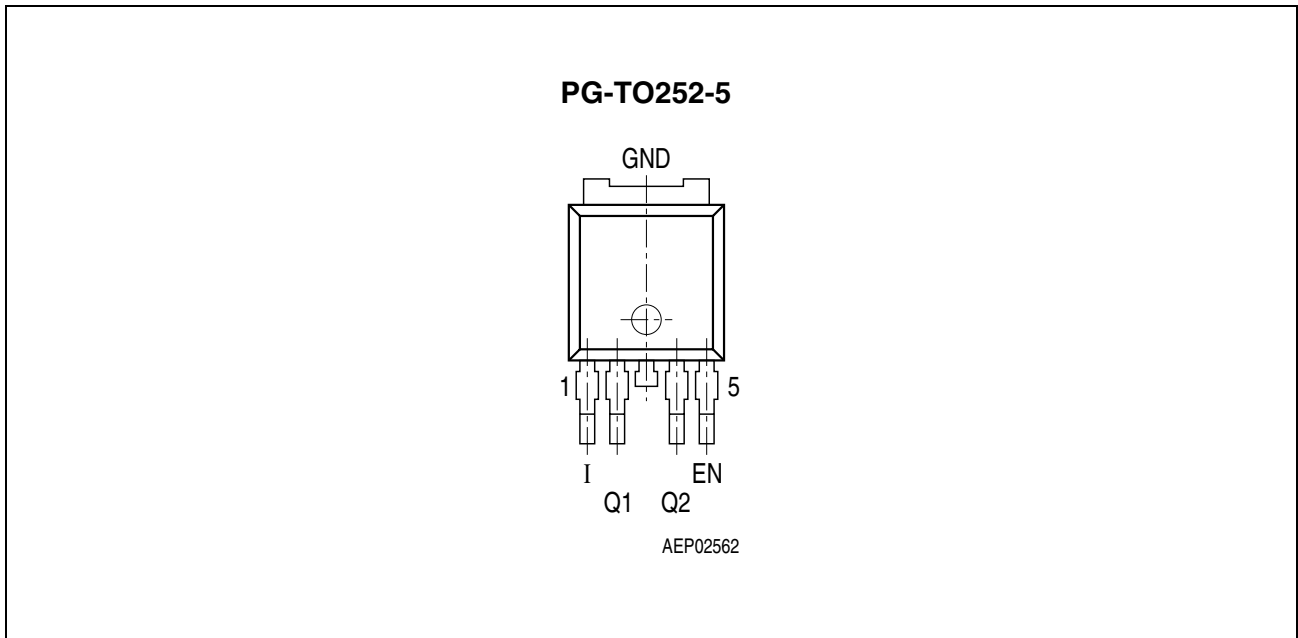

**Figure 1 Pin Configuration (top view)**

**Table 1 Pin Definitions and Functions**

Pin No.	Symbol	Function
1	I	<b>Input voltage;</b> block to GND directly at the IC with a ceramic capacitor
2	Q1	<b>3.3 V output;</b> block to GND with a capacitor $C_{Q1} \geq 10 \mu\text{F}$ , $\text{ESR} < 2 \Omega$ at 10 kHz
3	GND	<b>Ground</b>
4	Q2	<b>5.0 V output;</b> block to GND with a capacitor $C_{Q2} \geq 10 \mu\text{F}$ , $\text{ESR} < 3 \Omega$ at 10 kHz
5	EN	<b>Enable input;</b> to switch ON and OFF Q2, ON with high signal

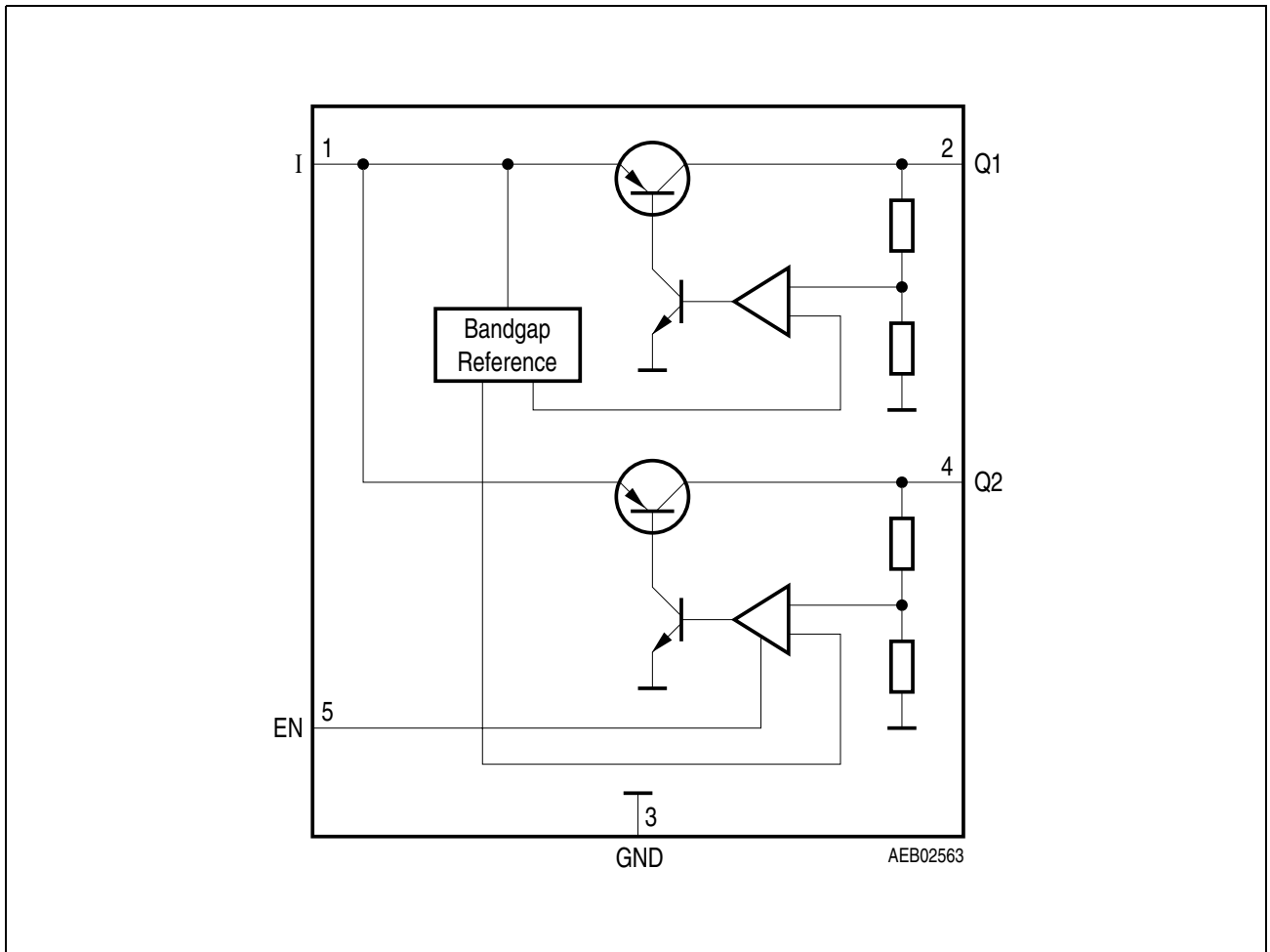

**Figure 2**    **Block Diagram**

**Table 2 Absolute Maximum Ratings**
 $-40\text{ °C} < T_j < 170\text{ °C}$ 

Parameter	Symbol	Limit Values		Unit	Remarks
		Min.	Max.		
<b>Input I</b>					
Voltage	$V_I$	-42	42	V	– $t < 400\text{ ms}$
		–	65	V	
Current	$I_I$	–	–	mA	Internally limited
<b>3.3 V Output Q1</b>					
Voltage	$V_{Q1}$	-1	36	V	–
Current	$I_{Q1}$	–	–	mA	Internally limited
<b>5.5 V Output Q2</b>					
Voltage	$V_{Q2}$	-1	36	V	–
Current	$I_{Q2}$	–	–	mA	Internally limited
<b>Inhibit EN</b>					
Voltage	$V_{EN}$	-42	42	V	– $t < 400\text{ ms}$
		–	65	V	
Current	$I_{EN}$	–	–	mA	Internally limited
<b>Temperatures</b>					
Junction temperature	$T_j$	-50	170	°C	–
Storage temperature	$T_{stg}$	-50	150	°C	–

**Notes**

1. ESD-Protection according to MIL Std. 883:  $\pm 2\text{ kV}$ .
2. Stresses above those listed here may cause permanent damage to the device. Exposure to absolute maximum rating conditions for extended periods may affect device reliability.

**Table 3 Operating Range**

Parameter	Symbol	Limit Values		Unit	Remarks
		Min.	Max.		
Output 1 input voltage	$V_{I1}$	4.5	42	V	1)
Output 2 input voltage	$V_{I1}$	5.7	42	V	2)
3.3 V regulator output current	$I_{O1}$	0	350	mA	–
5 V regulator output current	$I_{O2}$	0	430	mA	–
Junction temperature	$T_j$	-40	170	°C	3)

**Thermal Resistances**

Junction case	$R_{th,j-case}$	–	3	K/W	–
Junction ambient	$R_{th,j-a}$	–	80	K/W	4)

- 1) Input voltage  $V_I$  required for operation of output Q1
- 2) Input voltage  $V_I$  required for operation of output Q2
- 3) The overtemperature protection is set to  $> 170\text{ °C}$ . The voltage regulator may not be operated continuously at  $170\text{ °C}$  as device reliability will be reduced to 500 h statistic lifetime.
- 4) Worst case regarding peak temperature, zero airflow; mounted on a PCB  $80 \times 80 \times 1.5\text{ mm}^3$ ,  $35\text{ }\mu\text{m Cu}$ ,  $5\text{ }\mu\text{m Sn}$ , heat sink area  $300\text{ mm}^2$ .

*Note: In the operating range the functions given in the circuit description are fulfilled.*

**Table 4 Electrical Characteristics**

$V_I = 13.5\text{ V}$ ;  $V_{EN} > V_{ENH}$ ;  $-40\text{ °C} < T_j < 150\text{ °C}$ ; unless otherwise specified.

Parameter	Symbol	Limit Values			Unit	Test Condition
		Min.	Typ.	Max.		
<b>3.3 V Output Q1</b>						
Output voltage	$V_{Q1}$	3.17	3.3	3.43	V	$1\text{ mA} < I_{Q1} < 250\text{ mA}$
Output current limitation	$I_{Q1}$	350	–	900	mA	<sup>1)</sup>
Load regulation	$\Delta V_{Q1}$	–	–	30	mV	$1\text{ mA} < I_{Q1} < 250\text{ mA}$
Line regulation	$\Delta V_{Q1}$	–	–	20	mV	$I_{Q1} = 5\text{ mA}$ ; $6\text{ V} < V_I < 28\text{ V}$
Power Supply Ripple Rejection	<i>PSRR</i>	–	60	–	dB	$20\text{ Hz} < f_r < 20\text{ kHz}^{2)}$ ; $V_r = 5\text{ Vpp}$
Output capacitor	$C_{Q1}$	10	–	–	$\mu\text{F}$	–
ESR of output capacitor	$R_{ESRQ1}$	–	–	2	$\Omega$	at 10 kHz
<b>5.0 V Output Q2</b>						
Output voltage	$V_{Q2}$	4.8	5.0	5.2	V	$1\text{ mA} < I_{Q2} < 330\text{ mA}$
Output current limitation	$I_{Q2}$	430	–	900	mA	<sup>1)</sup>
Drop voltage; $V_{DRQ2} = V_I - V_{Q2}$	$V_{DRQ2}$	–	0.3	0.7	V	$I_{Q2} = 330\text{ mA}^{1)}$
Load regulation	$\Delta V_{Q2}$	–	–	50	mV	$5\text{ mA} < I_{Q2} < 330\text{ mA}$
Line regulation	$\Delta V_{Q2}$	–	–	50	mV	$I_{Q2} = 5\text{ mA}$ ; $6\text{ V} < V_I < 28\text{ V}$
Power Supply Ripple Rejection	<i>PSRR</i>	–	60	–	dB	$20\text{ Hz} < f_r < 20\text{ kHz}^{2)}$ ; $V_r = 5\text{ Vpp}$
Output capacitor	$C_{Q2}$	10	–	–	$\mu\text{F}$	–
ESR of output capacitor	$R_{ESRQ2}$	–	–	3	$\Omega$	at 10 kHz

**Table 4 Electrical Characteristics (cont'd)**

$V_I = 13.5\text{ V}$ ;  $V_{EN} > V_{ENH}$ ;  $-40\text{ °C} < T_j < 150\text{ °C}$ ; unless otherwise specified.

Parameter	Symbol	Limit Values			Unit	Test Condition
		Min.	Typ.	Max.		
<b>Current Consumption</b>						
Quiescent current; $I_q = I_I - I_{Q1}$	$I_q$	–	100	150	$\mu\text{A}$	$T_j < 85\text{ °C}$ ; $V_{EN} = 0\text{ V}$
Quiescent current; $I_q = I_I - I_{Q1} - I_{Q2}$	$I_q$	–	300	400	$\mu\text{A}$	$I_{Q1} = I_{Q2} = 300\ \mu\text{A}$ ; $T_j < 85\text{ °C}$
Quiescent current; $I_q = I_I - I_{Q1} - I_{Q2}$	$I_q$	–	2.5	10	mA	$I_{Q1} = 150\text{ mA}$ ; $I_{Q2} = 300\ \mu\text{A}$
Quiescent current; $I_q = I_I - I_{Q2} - I_{Q1}$	$I_q$	–	5	13	mA	$I_{Q1} = 300\ \mu\text{A}$ ; $I_{Q2} = 250\text{ mA}$
<b>Enable Input EN</b>						
EN ON voltage	$V_{EN\ ON}$	1.8	–	–	V	$V_{Q2}\ \text{ON}$
EN OFF voltage	$V_{EN\ OFF}$	–	–	1.0	V	$V_{Q2}\ \text{OFF}$
Input current	$V_{EN}$	–	20	30	$\mu\text{A}$	$V_{EN} = 13\text{ V}$

- 1) Measured when the output voltage  $V_Q$  has dropped 100 mV from the nominal value.
- 2) Guaranteed by design.

## Application Information

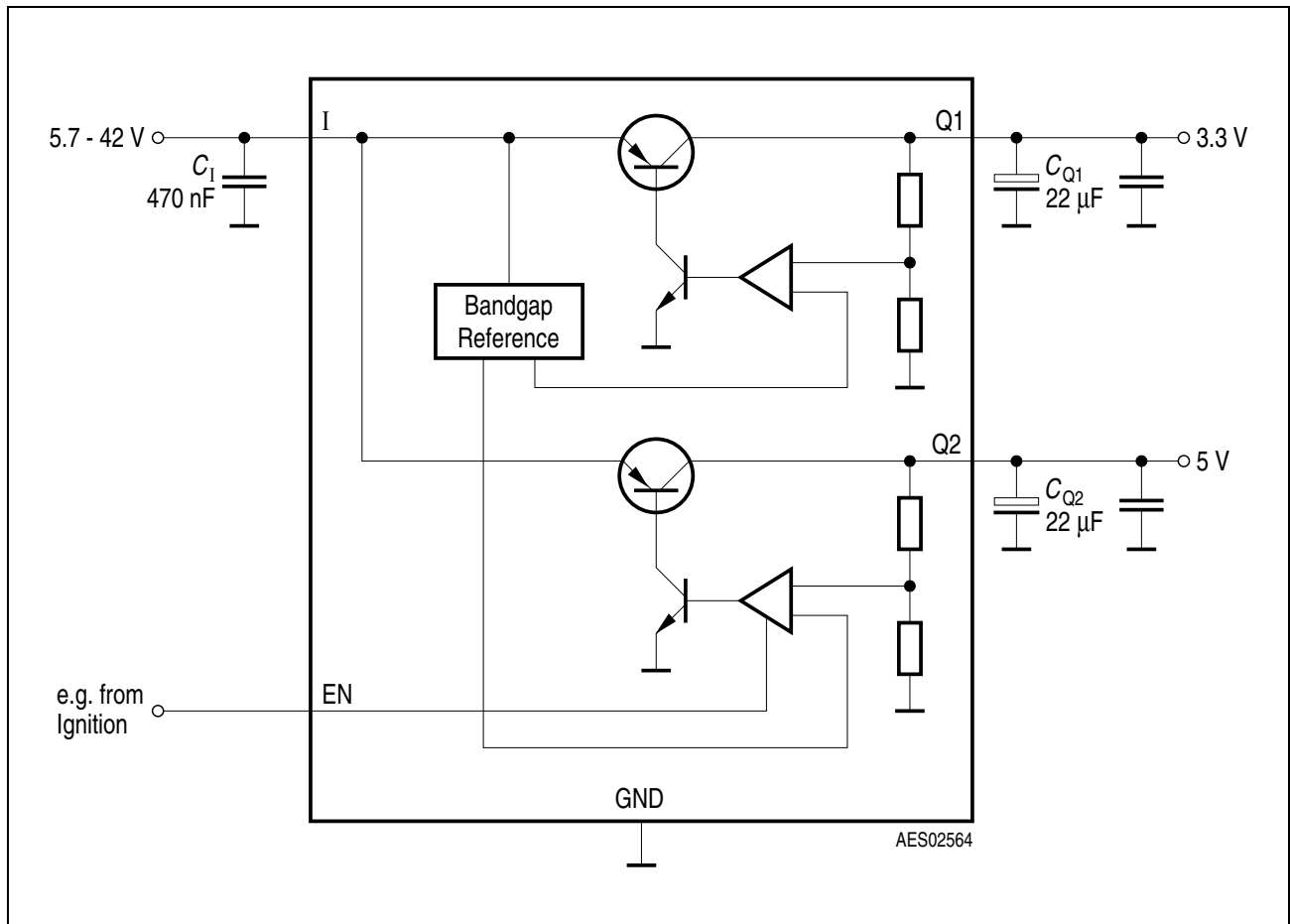

**Figure 3 Application Circuit**

### Input, Output

The input capacitor  $C_1$  is necessary for compensating line influences. Using a resistor of approx.  $1 \Omega$  in series with  $C_1$ , the LC circuit of input inductivity and input capacitance can be damped. To stabilize the regulation circuits of the stand-by and main regulator, output capacitors  $C_{Q1}$  and  $C_{Q2}$  are necessary. Stability is guaranteed at values  $C_{Q1} \geq 10 \mu\text{F}$  ( $\text{ESR} \leq 2 \Omega$ ) and  $C_{Q2} \geq 10 \mu\text{F}$  ( $\text{ESR} \leq 3 \Omega$ ) within the operating temperature range.

### Enable

Using the enable feature the output 2 (5 V output) can be switched ON or OFF. The enable input can be connected directly to terminal 30 (battery line) or 15 (ignition line). It is also possible to control the output 2 via the microcontroller.



**Typical Performance Characteristics**

**Output Current  $I_{Q1}$  versus Input Voltage  $V_I$**

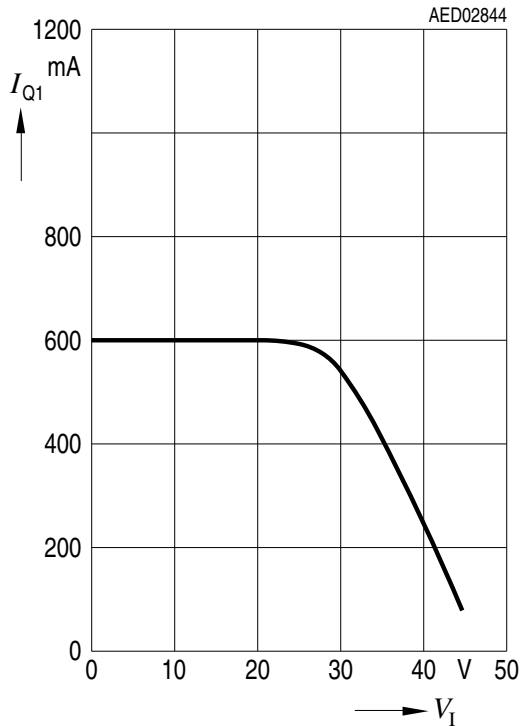

**Output Current  $I_{Q2}$  versus Input Voltage  $V_I$  Enable ON**

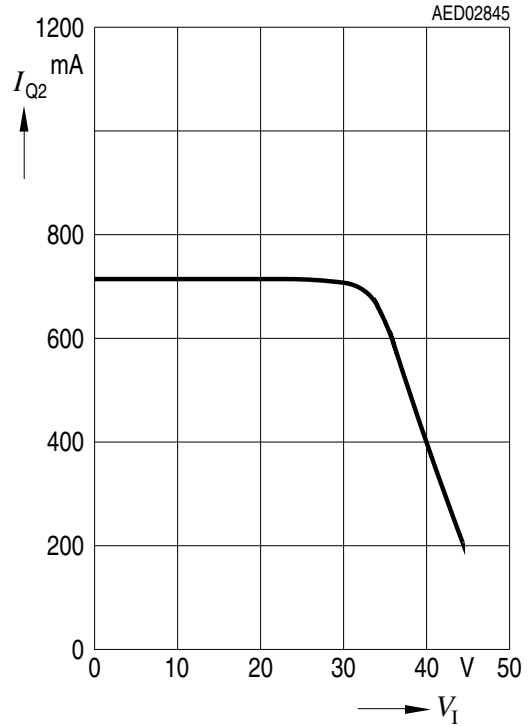

**Output Voltage  $V_{Q2}$  versus Temperature  $T_j$**

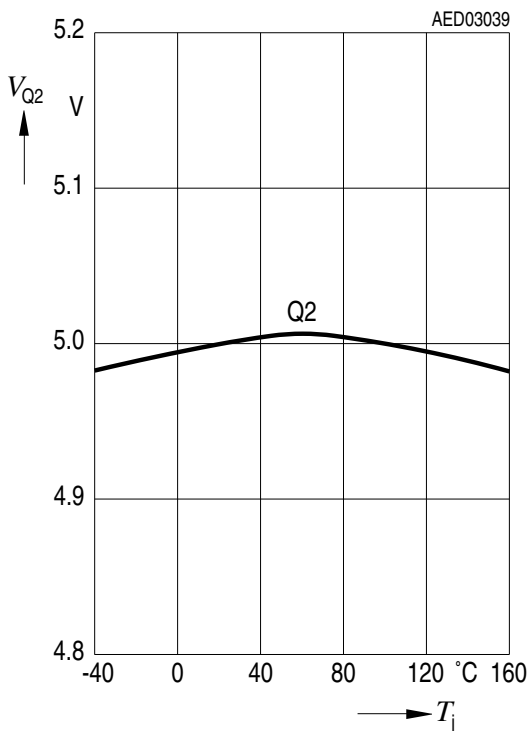

**Output Voltage  $V_{Q1}$  versus Temperature  $T_j$**

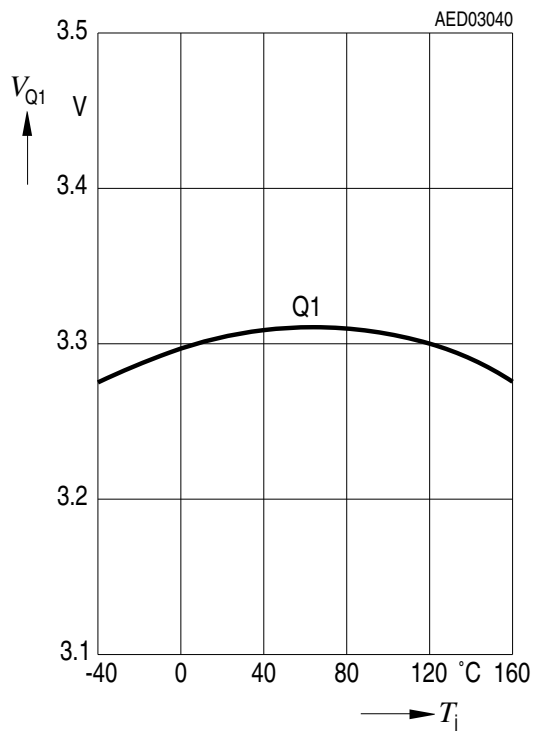

**Drop Voltage  $V_{DR1}$  versus Output Current  $I_{Q1}$**

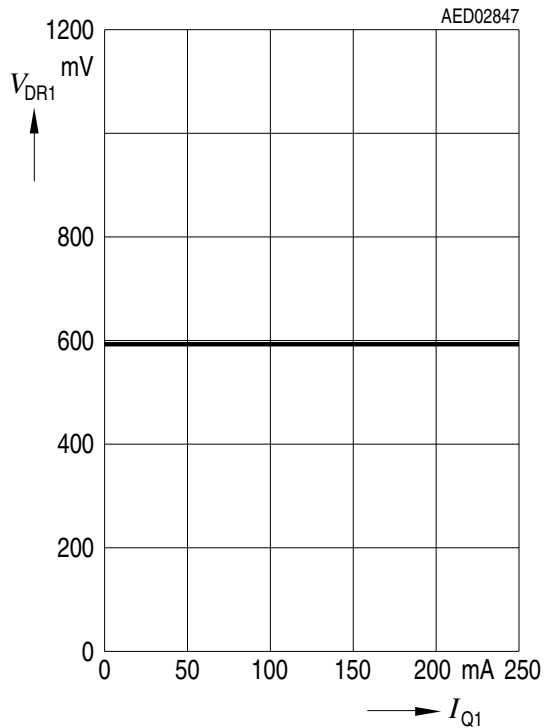

**Drop Voltage  $V_{DR2}$  versus Output Current  $I_{Q2}$  EN ON**

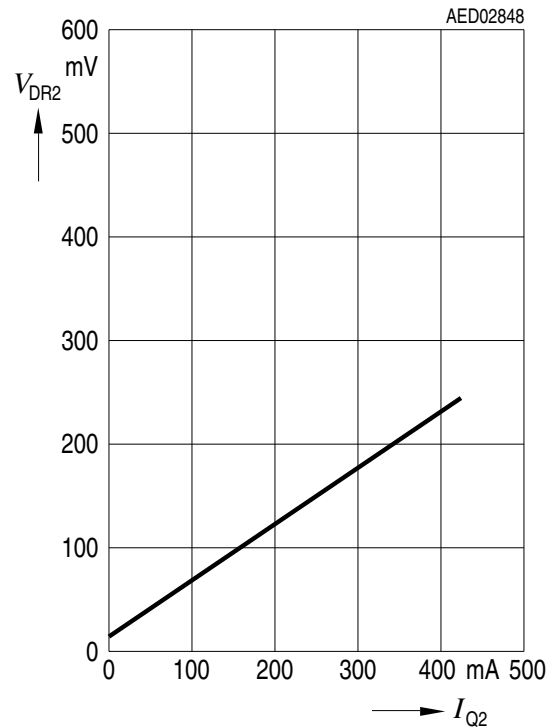

**Current Consumption  $I_q$  versus Input Voltage  $V_I$**

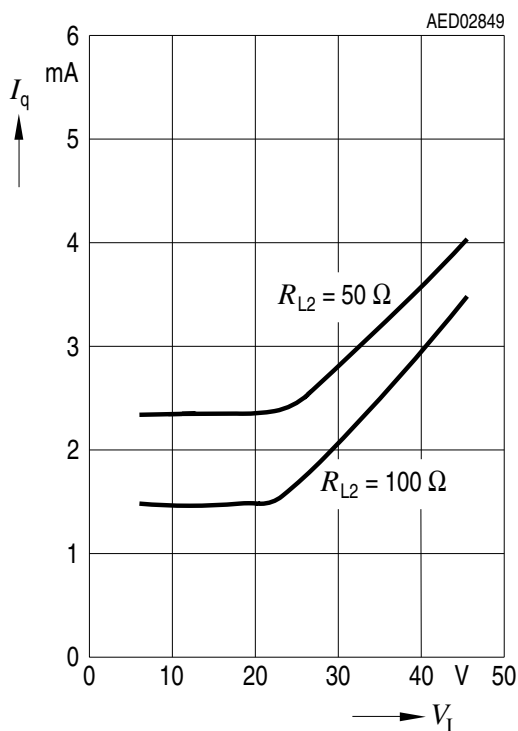

**Current Consumption  $I_q$  versus Input Voltage  $V_I$**

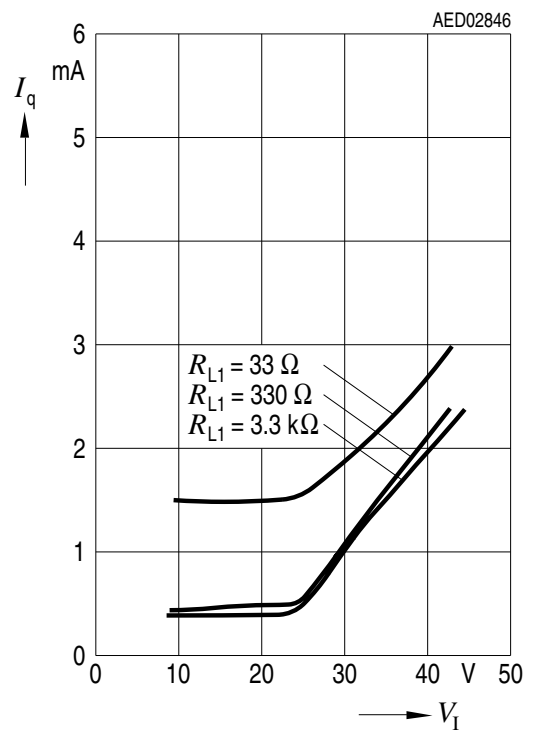

**Current Consumption  $I_q$  versus Output Current  $I_{Q1}$**

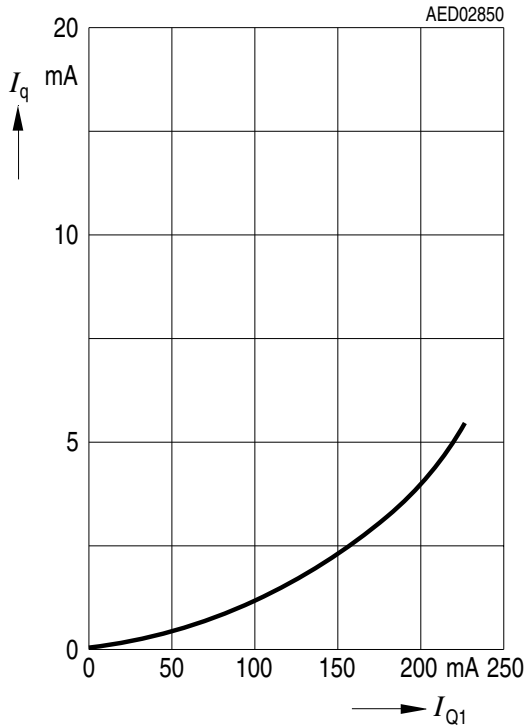

**Current Consumption  $I_q$  versus Output Current  $I_{Q2}$**

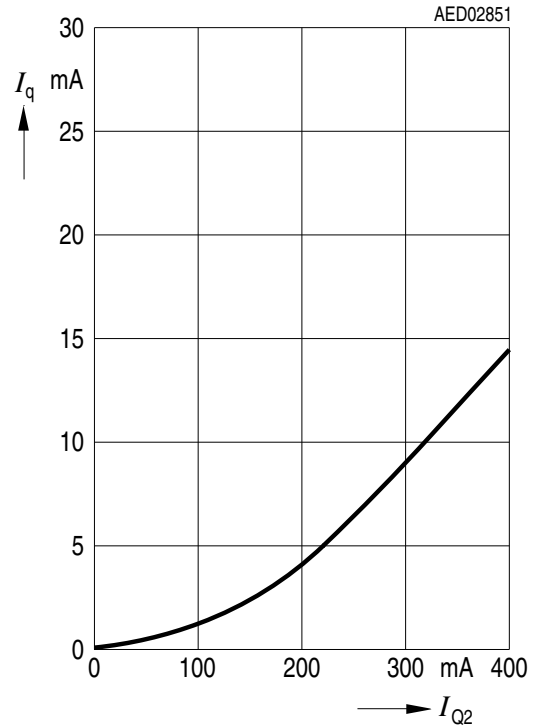

**Output Voltage  $V_{Q1}$  versus Input Voltage  $V_I$**

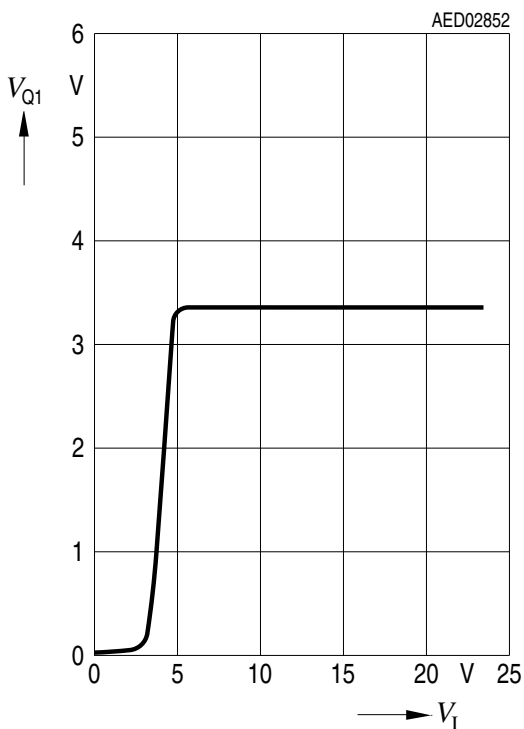

**Output Voltage  $V_{Q2}$  versus Input Voltage  $V_I$**

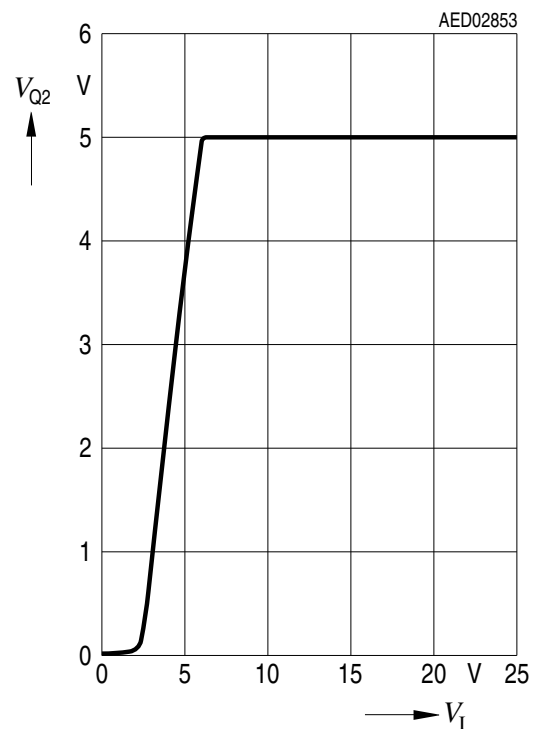

Package Outlines

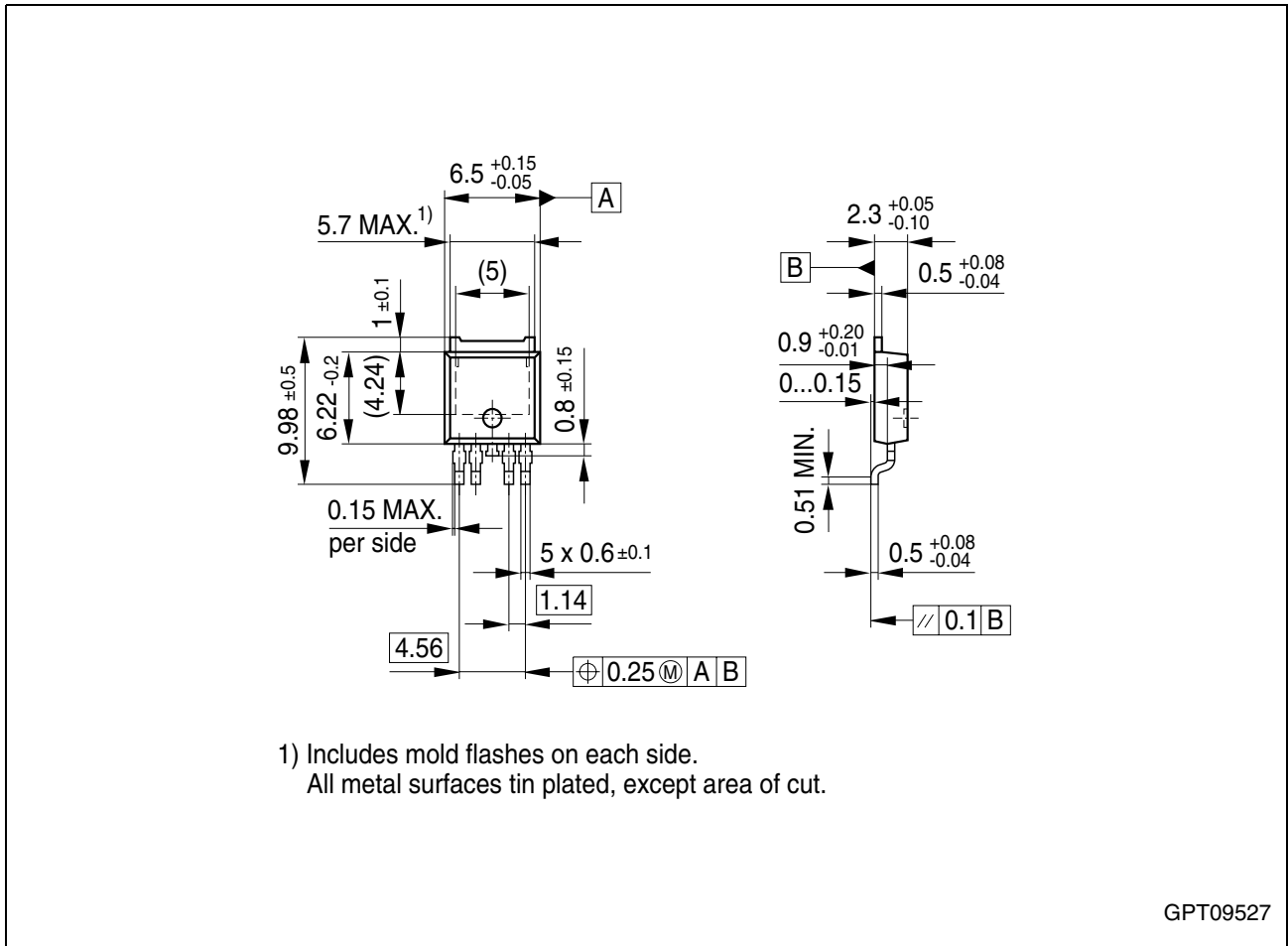

Figure 4 PG-TO252-5-11 (Plastic Transistor Single Outline)

Green Product (RoHS compliant)

To meet the world-wide customer requirements for environmentally friendly products and to be compliant with government regulations the device is available as a green product. Green products are RoHS-Compliant (i.e Pb-free finish on leads and suitable for Pb-free soldering according to IPC/JEDEC J-STD-020).

You can find all of our packages, sorts of packing and others in our Infineon Internet Page "Products": <http://www.infineon.com/products>.

SMD = Surface Mounted Device

Dimensions in mm

---

**Revision History**

<b>Version</b>	<b>Date</b>	<b>Changes</b>
Rev. 2.5	2007-03-20	Initial version of RoHS-compliant derivate of TLE 4476 <b>Page 1</b> : AEC certified statement added <b>Page 1</b> and <b>Page 12</b> : RoHS compliance statement and Green product feature added <b>Page 1</b> and <b>Page 12</b> : Package changed to RoHS compliant version Legal Disclaimer updated

**Edition 2007-03-20**

**Published by  
Infineon Technologies AG  
81726 Munich, Germany**

**© 2007 Infineon Technologies AG  
All Rights Reserved.**

#### **Legal Disclaimer**

The information given in this document shall in no event be regarded as a guarantee of conditions or characteristics. With respect to any examples or hints given herein, any typical values stated herein and/or any information regarding the application of the device, Infineon Technologies hereby disclaims any and all warranties and liabilities of any kind, including without limitation, warranties of non-infringement of intellectual property rights of any third party.

#### **Information**

For further information on technology, delivery terms and conditions and prices, please contact the nearest Infineon Technologies Office ([www.infineon.com](http://www.infineon.com)).

#### **Warnings**

Due to technical requirements, components may contain dangerous substances. For information on the types in question, please contact the nearest Infineon Technologies Office.

Infineon Technologies components may be used in life-support devices or systems only with the express written approval of Infineon Technologies, if a failure of such components can reasonably be expected to cause the failure of that life-support device or system or to affect the safety or effectiveness of that device or system. Life support devices or systems are intended to be implanted in the human body or to support and/or maintain and sustain and/or protect human life. If they fail, it is reasonable to assume that the health of the user or other persons may be endangered.